



RADIO'S LIVEST MAGAZINE

Special
AUTO-RADIO
Number

Radio-Craft

June
25 Cents
in United States
and Canada

HUGO GERNSBACK Editor

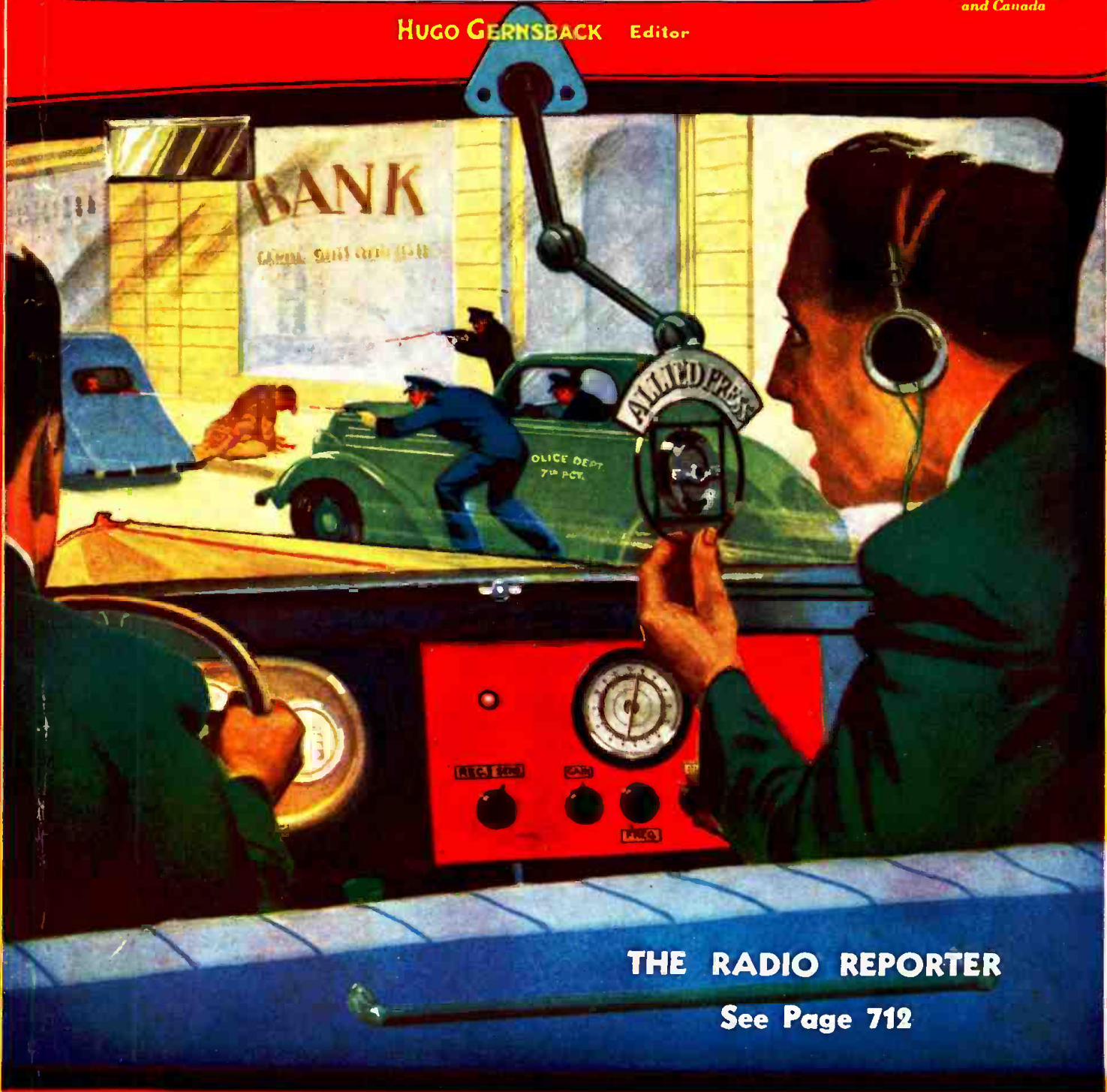

THE RADIO REPORTER

See Page 712

Making the RADIO-CRAFT Car-Radio Receiver—New "Anti-Howl" Audio Amplifier
Making a Precision Aligning Instrument — Diagrams of Newest Car-Radio Sets

NOW!

GET THIS AMAZINGLY VERSATILE SUPREME INSTRUMENT

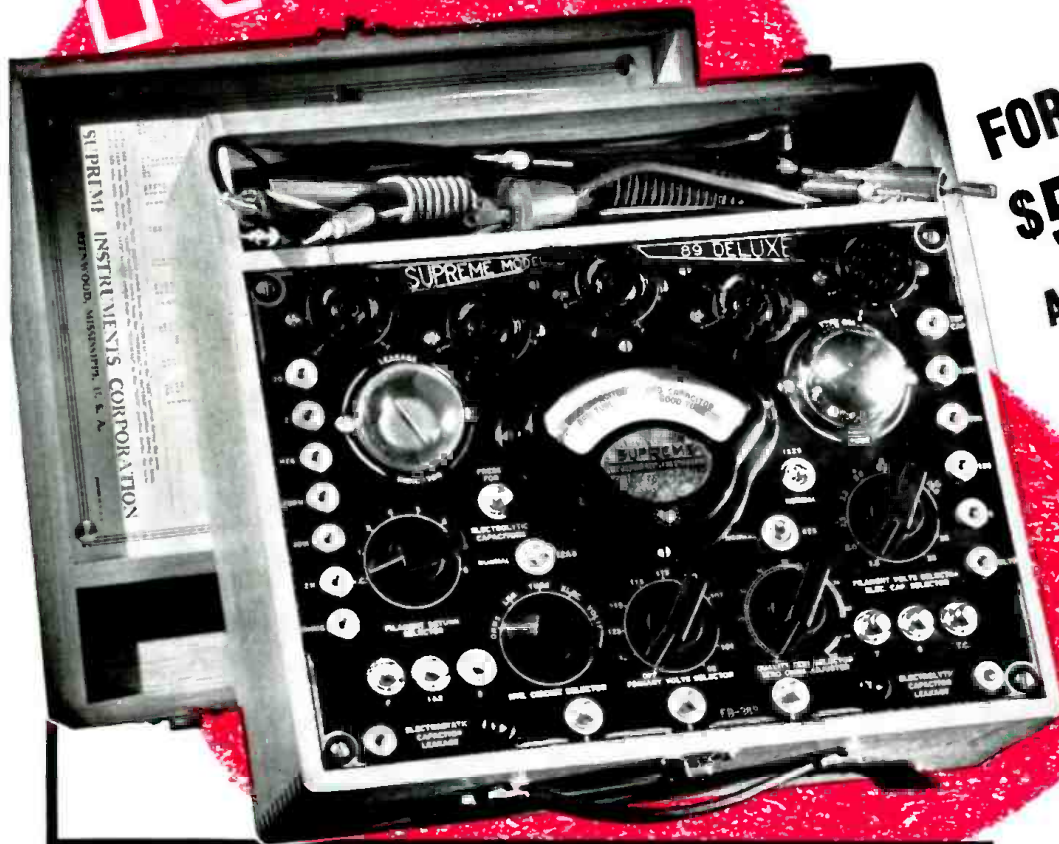

FOR ONLY \$5.00 DOWN AND \$4.55 PER MONTH

FROM YOUR OWN JOBBER

You can still get SUPREME instruments on the easiest terms ever offered. Our own S. I. C. Payment Plan allows you to select whatever equipment you need—either portable or counter type—and pay for it in ten easy monthly payments. **NO RED TAPE!** Just go (or write) to your jobber **NOW**—order any Supreme Instrument you want—fill out the S. I. C. form—and we will take care of everything! Don't pass up this opportunity!

TERMS AND SCHEDULE OF PAYMENTS

Model	Cash Price	Time Pay't Price	Deposit	Monthly Payment
385 Automatic	77.95	85.75	8.50	7.72 (10 months)
89 De Luxe	45.95	50.55	5.00	4.55 (10 months)
339 De Luxe	39.95	43.95	4.50	3.94 (10 months)
189 Signal Generator	36.95	40.65	4.00	3.66 (10 months)

Other SUPREME instruments may be purchased on equally convenient terms.



The full line of SUPREME Instruments and all the details on the easiest payment plan in history are described and illustrated in a new folder just off the press! Write for your **FREE** copy **TODAY!**

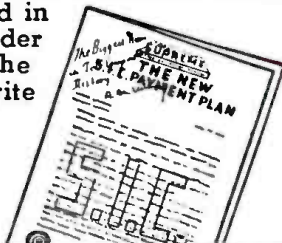

SUPREME INSTRUMENTS CORP., Greenwood, Miss., U. S. A.
 Export Dept., Associated Exporters Co., 145 W. 45th St., New York City, N. Y. Cable Address, LOPREH, N. Y.

Learn to Earn \$30, \$40, \$50, and Up a Week in ELECTRICITY

WHETHER you are 16 or 40 years of age, Electricity offers you a real future... Don't waste your best years in a low pay untrained job, or worse yet, never sure of even a poor paid job. Get into a real live, money making field where thousands of men make \$30, \$40, \$50 and up a week in the fascinating field of electricity. Prepare today for a good job in a field that's full of opportunities for trained men.

Learn by Doing... in 12 Weeks in the Big Chicago Coyne Shops

The remarkable "Learn by Doing" method used in the great Coyne Shops trains you to master Electricity and its many branches in 12 weeks. Actual shop work—not a correspondence course—you don't have to recite. You are trained by actual work in modern daylight shops on the finest kind of Electrical equipment, under personal supervision of expert instructors. That's why Coyne Training prepares you as a real practical Electrician in such a short time.

You Don't Need Previous Experience or a Lot of Book Learning

Many of our successful graduates have not even completed common school. At Coyne you learn by actual experience on a wide variety of up-to-date generators, motors, dynamos, batteries, automotive and aviation engines, electric signs, etc. Do the actual jobs you will be called on to do out in the field. When you finish Coyne Training you can confidently tackle any job, for you will have actually had similar work during your training.

On Jobs Like These—No Correspondence Real Work on Modern Electrical Equipment

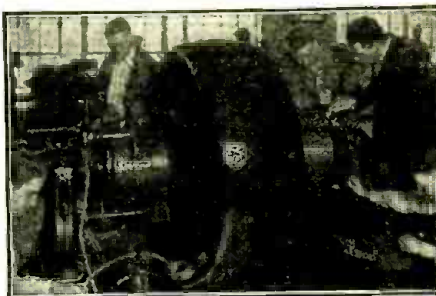

Working on Real Electrical Equipment at Coyne

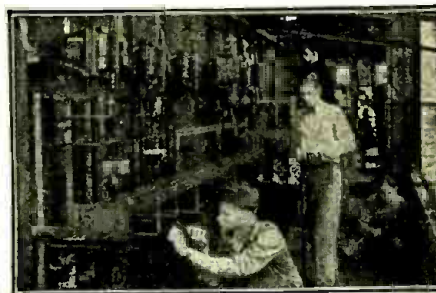

A Real Switchboard in the Coyne Shops

NOT A CORRESPONDENCE COURSE

Here in the Coyne Shops in Chicago, you learn quickly because we show you how to work with your head and hands—not by correspondence or book study—but by actual work on the kind of electrical apparatus you will find, out on the job after you graduate.

ASTOUNDING! Offer! 18 MONTHS TO PAY FOR YOUR TRAINING in Small Monthly Payments after you graduate!



Get your training first—then pay back tuition in easy monthly payments starting 5 months from the date you start school, or 2 months after the required 12-weeks training period is over. And

you'll have 18 months to complete your payments. Mail the coupon now and I will send you, without obligation, full details of this astounding offer! *H. C. Lewis*



DIESEL ENGINES, REFRIGERATION, AIR CONDITIONING.

Included Without Extra Cost

The fastest growing industries in America today. Manufacturers and Distributors of Refrigeration and Air Conditioning equipment need Trained men who have Specialized in these rapidly expanding fields. Here at Coyne you will prepare to fill a job as Installation and Service man, Shop Mechanic, Tester, Assembler, Inspector, etc. You will learn about various types of compressors, condensers, temperature control devices, thermostatic and expansion valves—you will do actual work on latest types of Refrigerating and Air Conditioning machines. And, it won't cost you one extra cent to get this remarkable training. I include it absolutely Free with your regular Electrical Training.

Earn Living Expenses While You're Training

Many of my students work part time to help pay their living expenses while they are training. If you need this work we will do our best to get it for you. Send coupon for details.

Employment Help For You After Graduation

My Graduate Employment Service will give you real employment help. As one of my graduates you will get assistance quickly, and every help we can give you to locate a job for which you have been trained. You will also get free technical and business service and privilege of review at any time without additional tuition charge.

GET MY FREE BOOK

Get the new "Coyne Opportunity Book," giving all facts about Coyne Training. Photographs of Shops showing students at work on modern electric equipment under the personal supervision of Coyne Expert Instructors. Also details of my Spare Time Employment Offer, Pay After Graduation Plan and Graduate Employment Service. Yours without cost. Simply Mail the coupon.



MAIL COUPON NOW!

**H. C. Lewis, President
Coyne Electrical School, Dept. A6-78
500 S. Paulina St., Chicago, Ill.**

Send me your big FREE Book about Coyne Training and give me all details regarding your "Spare Time Employment Offer" and "Pay-Tuition-After-Graduation" Plan of easy, monthly payments.

NAME.....

ADDRESS.....

CITY..... STATE.....

Mail in envelope or paste on postcard

COYNE H. C. LEWIS, Pres. Founded 1899
ELECTRICAL SCHOOL
500 S. Paulina St., Dept. A6-78, Chicago, Ill.

Please Say That You Saw It in RADIO-CRAFT



HUGO GERNSBACK, Editor-in-Chief
 C. W. PALMER Associate Editor
 H. G. McENTEE Associate Editor
 R. D. WASHBURNE, Technical Editor

CONTENTS - JUNE 1936, ISSUE

Volume VII

Number 12

Editorial: Mobile Radio.....	Hugo Gernsback	709
The Radio Month in Review.....		710
New Ideas in "Car"-Radio.....	H. G. McEntee	712
Latest Car-Radio Receivers.....		712
New Car-Radio Developments.....	R. D. Washburne	713
Diagrams of the Newest Car-Radio Receivers.....		714
Short-Cuts in Radio.....		716
How to Make a 2½ to 555 Meter DX Set	A. J. Haynes	717
Public Address—A Misnomer.....	Philip R. Baus	717
A Portable High-Fidelity P.A. Amplifier	I. A. Mitchell	718
Design Data on A.V.C. Circuits—Part I.....		718
How Do We Hear?—Part II.....	N. H. Lessem	719
International Radio Review.....		720
New Devices for the Car-Radio Owner.....		721
How to Make the RADIO-CRAFT Car-Radio Set.....		722
Recent Tube Developments.....	C. W. Palmer	724
Important Facts About School Sound Systems— Part II.....	R. H. von Liedtke	724
The "Anti-Howl" Audio Amplifier—A New Develop- ment in Sound Equipment.....	A. C. Shaney	725
Operating Notes		726
A Simplified Decade Resistance Box	G. F. Benkelman	727
Installing Indoor and Outdoor P.A. Systems—Part II	E. L. Richards and J. P. Hanan	727

ORSMA Members' Forum.....		728
The Design of Modern Test Equipment—Part III	Samuel C. Milbourne	728
Description of a New Frequency Wobbler for Set Aligning.....	Allen B. DuMont	729
Radio Pictorial		730
Scotland Yard's New Radio System.....		731
New Developments in 7-Meter Police Radio	M. L. Prescott	731
Making a Precision Aligning Unit—Part I	Canio Maggio	732
Build This Beginner's 2-Tube All-Wave Set	Donald Lewis	733
The Latest Radio Equipment.....		734

RADIO-SERVICE DATA SHEETS:

No. 166—Sparton Models 566 ("Bluebird" Mirror) 506 and 594 A.C.-D.C. 5-Tube 2-Band Midget Super; Atwater Kent 776 6-Tube Auto-Radio Set.....		736
No. 167—International Model 77 7-Tube Dual- Band Receiver; RCA Victor Model M109 7-Tube Auto Receiver....		738
No. 168 Crosley Model 6625 6-Tube 3-Band Re- ceiver; Stromberg-Carlson No. 61 A.C.-D.C. Receiver....		739
Electronic Music Fundamentals—Part III	Edward Kassel	737
New Data on Portable Batteries.....		737
Technicians' Data Service.....		741
Book Review		764

ANNUAL SERVICE NUMBER

Service Men—this is your own special issue, published once each year especially for you! While every issue of RADIO-CRAFT contains a wealth of useful data for Service Men, this issue is filled to overflowing with just the information you have been looking for. Articles on the construction of up-to-date servicing equipment—Data on the latest sets, amplifiers and accessories—Operating

Notes covering common causes of breakdown in popular receivers as found by Service Men in their work—And many other subjects of vital interest to every Service Man, regardless of the particular branch of radio in which he specializes, will be included. You can't afford to miss the July issue of RADIO-CRAFT, on the newsstands June 1st. Reserve your copy today through your local news dealer.

HUGO GERNSBACK, President I. S. MANHEIMER, Secretary
 Published by Continental Publications, Inc. Publication office: 29
 Worthington Street, Springfield, Mass. Editorial and Advertising
 Office: 99 Hudson Street, New York City. Chicago Advertising
 Office: L. F. McClure, 919 North Michigan Avenue, Chicago, Ill.
 Western Advertising Office: Loyd B. Chappell, 511 So. Alexandria St.,
 Los Angeles, Calif.

European Agents:

London—Gorrings's American News Agency, 9A Green St., Leices-
 ter Square, London, W. C. 2.

Paris—Messageries Dawson, 4 Rue Faubourg, Poissonnière, Paris,
 France.

Australian Agent: McGill's Agency, 179 Elizabeth St., Melbourne.

RADIO-CRAFT is published monthly, on the first of the month preced-
 ing that of date; subscription price is \$2.50 per year in U. S. and Can-
 ada. (In foreign countries, \$3.00 a year to cover additional postage.)
 Entered at the post office at Springfield as second-class matter
 under the act of March 3, 1879.

Text and illustrations of this magazine are copyright and must not be
 reproduced without permission of the copyright owners. We are also
 agents for EVERYDAY SCIENCE AND MECHANICS. Subscription
 to this magazine may be taken in combination with RADIO-CRAFT
 at reduced Club rates. Write for information.

Copyright 1936. Continental Publications, Inc.

I WILL TRAIN YOU AT HOME IN SPARE TIME FOR A GOOD RADIO JOB!



J. E. SMITH, Pres.
National Radio Institute

HERE'S PROOF

Manager, Radio Service Department



"Before taking the N. R. I. course, I was a 'flunky' in a furniture store. Now I have a job as manager of the Radio Service Department of one of Mississippi's largest furniture stores. Since starting your course, I have made over \$3,000."—D A V I D J. S H U M A K E R, R. 2, Box 105-F, Vicksburg, Miss.

Earns Money Quick in Radio

"I joined the N. R. I. and in a few weeks I worked three hours and made clear one five dollar bill. Since that time I have gotten married, have bought my home, a nice place valued at \$3,500 during the so-called depression, and have one of the nicest, most pleasant jobs that a man has ever known. And it is all mine. I own it."—E. L A M A R J O H N S T O N, 250 Fifth Ave., Rome, Georgia.



\$75 IN ONE WEEK

"One week my business netted \$75.00 on repairing alone, and there were sales to be added. I have only you to thank for it. In my estimation, N. R. I. is the best home-study school in the United States."

—R. S. LEWIS, Box 514, Pittsfield, Ill.

Get my FREE LESSON on Radio Servicing Tips

I'll prove that my training is practical, money-making information, that it is easy to understand—that it is just what you need to master radio. My sample lesson text, "Radio Receiver Troubles—the Cause and Remedy" covers a long list of radio receiver troubles in A. C., D. C., battery, universal, auto. T. R. F., super-heterodyne, all-wave and other types of sets. And a cross reference system gives you the probable cause and a quick way to locate and remedy these set troubles. A special section is devoted to receiver check-up, alignment, balancing, neutralizing and testing. Get this lesson Free. No obligation. Just mail coupon.



FREE BOOK TELLS HOW MAIL COUPON

Act today for better pay. Act to break away from a low-pay, no-future job. To get away from having to skimp, scrape to pay your bills. Mail coupon for my free 64-page book. It tells you how I will train you at home in your spare time to be a Radio Expert; about my training that has helped hundreds of men to make more money.

Many Radio Experts Make \$30, \$50, \$75 a Week

Consider these facts—think of the good jobs they stand for. Over 20,000,000 Radio sets in use, over 600 broadcasting stations, over 40 manufacturers of Radio sets, over 2,000 manufacturers of parts, over 100 Police Departments Radio equipped, airplanes and airports Radio equipped. Thousands of ships touching every seaport of the world are Radio equipped. Over 35,000 stores selling sets and parts, over 2,000,000 autos Radio equipped. Loud speaker systems wherever people gather, indoors and outdoors. Commercial Radio stations dotting our coast lines. Radio a big industry—is growing bigger. A few hundred \$30, \$50, \$75 a week jobs have grown to thousands in recent years.

Get Ready Now for Jobs Like These

A spare time or full time service shop; installing, maintaining, operating—broadcast, aviation, commercial, ship, television and police stations. A Radio retail or service business of your own. Installing, maintaining, servicing, loud speaker systems. A service or sales job with a store or jobber. I'll train you for good jobs in many branches of Radio.

Many Make \$5, \$10, \$15 a Week Extra in Spare Time Almost at Once

Every neighborhood can use a good part time serviceman. The day you enroll I start sending you Extra Money Job Sheets which quickly show you how to do Radio repair jobs common in almost every neighborhood. Get my book—see for yourself that many of my students make \$200 to \$1,000 in their spare time while learning. Stanley Tulk, 1823 Orleans St., Montreal, Canada, writes—"I have been doing so much service work I haven't had time to study. In two months, I made about \$200 in spare time." Lloyd V. Sternberg, 428 Benson Ave., West, Willmar, Minn., tells me—"I earned enough in spare time to pay for my course. In one month I earned \$125 in spare time." Yes, my training pays!

Your Money Back if Not Satisfied

I'll make this agreement with you. If you are not entirely satisfied with my Lesson and Instruction Service when you finish, I'll refund your tuition.

Find Out What Radio Offers

Mail the coupon. My book of information on Radio's spare time and full time opportunities is free to ambitious men. Read what Radio offers you. Read about the training I give you. Read letters from graduates—what they are doing and earning. There's no obligation. Mail coupon in an envelope or paste it on a penny post card—NOW.

J. E. SMITH, President
National Radio Institute, Dept. 6FX
Washington, D. C.

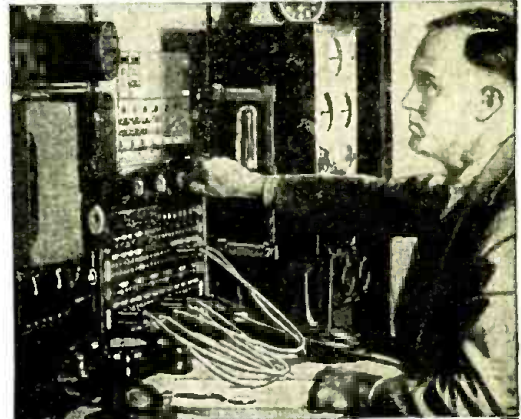

SAVE MONEY—LEARN AT HOME My Special Equipment Gives You Broad Practical Experience

Hold your job. No need to leave home and spend a lot of money to become a Radio Expert. I'll train you quickly and inexpensively right at home in your spare time. You don't need a high school or college education. Many of my successful graduates didn't finish grade school. My practical 50-50 method of training—half with lessons, half with Radio equipment—I furnish—gives you broad practical experience—makes learning at home easy, fascinating, practical and quick. There is opportunity for you in Radio. Old jobs are becoming more complicated—many need better trained men. New developments are making new opportunities. Short waves, loud speaker systems, police Radio, auto Radio, aviation Radio, television—Radio's newest uses are covered by my training. Here's a field that's growing. It is where you find growth that you find opportunity.

I have helped
hundreds of
men make
more money

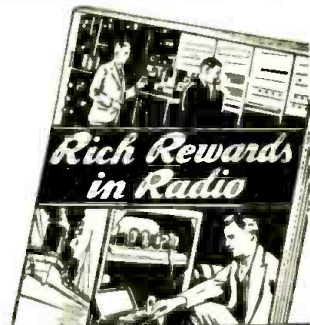

MAIL THIS NOW!

J. E. SMITH, President
National Radio Institute, Department 6FX
Washington, D. C.

Dear Mr. Smith: Without obligation, send me the Sample Lesson and your free book about spare time and full time Radio opportunities, and how I can train for them at home in spare time. (Please write plainly.)

NAME AGE
ADDRESS
CITY
STATE 14X-1

The Tested Way to BETTER PAY

Please Say That You Saw It in RADIO-CRAFT

Be Prepared to Meet All Radio Servicing Emergencies WITH GERNSBACK OFFICIAL RADIO SERVICE MANUALS



Just as we say—"Be prepared to meet all radio servicing emergencies with the Gernsback Official Radio Service Manuals." You never know when a service job requires that "extra" special attention. It might mean the difference between doing the job or losing it. You're safe if you have on hand the GERNSBACK MANUALS—either for regular service work or for servicing auto-radios. Get your copy today! No other radio book is comparable to the new 1935 OFFICIAL RADIO SERVICE MANUAL. In contents, in style of printing, in grade of paper, in illustrations, there has never been published such a comprehensive volume. This Manual contains over a thousand pages—yet it is only 1 1/4 inches thick because it is printed on a special Bible stock which is an exceptionally good stock, yet one of the thinnest and most durable papers. This 1935 Manual is the most authentic and elaborate service guide ever used in the radio industry.

Contents of the 1935 Manual

Over 1,000 pages full of diagrams and essential information of manufactured receivers—only data of real use in servicing is included. This new Manual is really portable since it is extremely thin and light as well. ● Volume V. continues where the preceding manual left off. ● Many circuits of old sets are included. ● Service Men know every set has certain weak points which are really the cause of trouble. Wherever the information could be obtained, these weaknesses with their cures are printed right with the circuits. This is an entirely new and valuable addition to the Manual. ● All the latest receivers are included—all-wave sets, short-wave sets, auto-radio sets, midjet and cigar-box sets, etc., as well as P.A. Amplifiers and equipment, and commercial serv-

icing instruments. ● The cumulative index is even more complete than before; including cross-references to sets sold under different names and type numbers. ● Volume V includes resistance data; socket layouts; I.F. data; and voltage data. ● Tube data on latest tubes. ● Free question and answer service—as included in our last three manuals.

OVER 1000 PAGES
Over 3,000 Illustrations
Size 9" x 12"—only 1 1/4" thick
Flexible, looseleaf leatherette cover

SET SERVICING

Service information found in the Manuals covers all types of radio receivers. The material is extremely valuable to Dealers and Service Men. On many diagrams appear voltage readings of tubes, socket connections, transformer data, alignment details, and other service notes.

PUBLIC ADDRESS

The pages on P.A. Installation will be helpful to Service Men and P.A. specialists. Such prominent features as class A and B amplifiers—single and dual channel systems—attenuators, and mixers—super-power stages—pre-amplifiers and other commercial devices for P.A. work are included.

ALL-WAVE RECEIVERS

Information relative to short-wave receivers have found their way into the Manuals. For these standard manufactured sets, wherever possible, complete aligning details for all wave bands are included in addition to the service material listed for other sets.

AUTO-RADIO RECEIVERS

All available service information on new auto-radio sets has been included. From this data alone Service Men could derive sufficient knowledge to venture in a specialty field—that of servicing only auto-radios.

\$7.00
LIST

Which of These GERNSBACK RADIO SERVICE MANUALS

Do You Need to Complete Your Files

1934 Official Radio Service Manual
Over 400 Pages, 9x12 Inches
Over 2,000 Illustrations
Flexible, Looseleaf, Leatherette Cover
List Price \$3.50

1933 Official Radio Service Manual
Over 700 Pages, 9x12 Inches
Over 2,000 Illustrations
Flexible, Looseleaf, Leatherette Cover
List Price \$5.00

1932 Official Radio Service Manual
Over 1,000 Pages, 9x12 Inches
Over 2,000 Illustrations
Flexible, Looseleaf, Leatherette Cover
List Price \$5.00

1931 Official Radio Service Manual
650 Pages (Including Supplements)
9x12 Inches
Over 1,500 Illustrations
Flexible, Looseleaf, Leatherette Cover
List Price \$4.50 (Including Supplements)

1933 Official Auto-Radio Service Manual (Volume I)
Over 200 Pages, 9x12 Inches
Over 500 Illustrations
Flexible, Looseleaf, Leatherette Cover
List Price \$2.50

—for the real auto-radio servicing "dope," you can't find a better book!

The 1935 Official Auto-Radio Service Manual

Every radio man connected in any way with the booming auto-radio business needs a copy of the new OFFICIAL AUTO RADIO MANUAL. It contains only auto-radio service "dope."

HERE ARE HIGHLIGHTS OF THE 1935 AUTO-RADIO SERVICE MANUAL

240 pages crowded with diagrams, service material and other essential data required for proper servicing of new auto-radio receivers. Included are diagrams of sets which appeared during 1934, and which were not included in the supplement to the first edition. Complete schematic diagrams, chassis layouts, voltage tabulations and servicing instructions are included for practically all sets. "Under-slide" tube symbols are also included to facilitate the job of servicing the sets. Instructions are included with many sets telling how to suppress stubborn cases of ignition interference. This includes the newest "suppressorless" sets—and what to do when interference is encountered with this type of set. Details on how to make installations in "turret-top" cars are included. The different methods used by car makers and set manufacturers are listed with the individual circuits and service information. The index contains the listing of sets which were published in the first edition, as well as the sets which appear in the new volume. This information helps the Service Man to locate the circuit and details for any receiver that has been made. The book is bound in a handy, flexible leatherette cover. To be sure the pages are sturdy, to withstand constant use, the book is printed on a special "bible" stock. This is a very durable, but thin paper. The book printed on this paper can be easily rolled to fit into your pocket or slipped in the service kit.



240 Pages
Over 500 Illustrations
Size 9 x 12"
Flexible, Looseleaf Leatherette Cover

\$2.50
LIST

MAIL COUPON TODAY FOR ANY MANUAL!

GERNSBACK PUBLICATIONS, Inc. RC-636
99 Hudson Street, New York, N. Y.

Enclosed you will find my remittance of \$..... for which please send me promptly, POSTPAID, the OFFICIAL RADIO SERVICE MANUAL indicated.

- | | |
|------------------------------------------------------------------------|-------------------------------------------------------------------|
| <input type="checkbox"/> 1935 Edition @ \$7.00 | <input type="checkbox"/> AUTO-RADIO MANUALS 1935 Edition @ \$2.50 |
| <input type="checkbox"/> 1934 Edition @ \$3.50 | <input type="checkbox"/> 1933 Edition @ \$2.50 |
| <input type="checkbox"/> 1933 Edition @ \$5.00 | |
| <input type="checkbox"/> 1932 Edition @ \$5.00 | |
| <input type="checkbox"/> 1931 Edition @ \$4.50 (Including Supplements) | |

Name

Address

City State

(Send remittance by check, money order, or registered letter if it contains cash, currency or unused U. S. Postage Stamps.)

GERNSBACK PUBLICATIONS, Inc.

99 Hudson Street

New York, N. Y.

OVERSEAS READERS!

These books can be obtained from the following houses:

GREAT BRITAIN
Gorrings', 9a, Green Street, Leicester Square, London, England

FRANCE
Editions Radio, 42 Rue Jacob, Paris

AUSTRALIA
McGill's 183-195, 218 Elizabeth St., Melbourne, C. I.

Please Say That You Saw It in RADIO-CRAFT



"Takes the Resistance out of Radio"

MOBILE RADIO

An Editorial by HUGO GERNSBACK

THE LATEST estimate of the number of car radio sets in the United States is close to 2 million. This is only a small percentage of the number of radio sets in automobiles, because at the time of writing there are over 23 million automobiles in the United States.

The new cars, however, are now practically *all* available radio-equipped, on order; or, if not so equipped, they are usually provided with aerials to which the automobile radio set can be connected.

On the other hand it should be considered that radio sets in automobiles are only *one* type of mobile radio, whereas new fields for *mobile radio sets* are springing up constantly.

The use of car radio sets in motor-boats and other small water craft is rapidly gaining popularity all over the country; for the simple reason that owners of water craft, particularly those who go out on lakes and the ocean, must be informed of storm warnings and must get their weather reports if disaster is not to overtake them. Even the canoeist on vacation can make splendid use of a *transceiver* (a combination transmitter and receiver, that utilizes the same equipment for both services) with which to keep in contact with the shore, and many radio amateurs have taken advantage of their licenses and technical ability to make the best use of such sets.

The modern commercial airplane could not very well do without a two-way radio set today, but private aircraft only up to very recently have not as a rule carried radio sets. It is not absolutely necessary for a private airplane to carry a two-way radio, although that is the best installation to be had if the safety factor is considered paramount. An ordinary radio set will help as a *direction-finder*, particularly if it is equipped with a "loop" antenna. When operated in this manner, even a regular broadcast station program when tuned-in serves as a "beacon" toward which the airplane can be directly steered. Commercial airplanes make use of this instrumentality, and it will not be long before private airplane owners will awaken to the fact that even the simplest of direction-finders may be worth *more than its weight in gold!* The importance of the direction finder is particularly evident in night flying, and during fogs when pilots easily lose their course.

Broadcast stations have long made use of radio-equipped cars in which two-way radio sets were installed so that operators could easily keep in touch with their studios in reporting sports and news events. Broadcast stations have found such radio-equipped cars to be highly efficient and very necessary to their business. Newspapers may soon take the hint (see cover illustration) and equip cars with transceivers so that the reporters can send in "spot" news right while the news is being made.

By means of short-wave radio, explorers from the wilds of the jungle can still keep in touch with the outside world via radio. Such short-wave sets are quite light and are usually battery operated for easier carrying. (It is also possible to dispense with the batteries by manufacturing the electric current by means of hand-driven dynamos. These are used for emergency purposes when the batteries fail.)

Commander Byrd during his recent Antarctic explorations found mobile radio of tremendous help to his expedition. Dog-sleds carried a two-way, short-wave, highly compact transceiver, by means of which it was always possible to maintain continuous contact with headquarters.

As radio sets become smaller and smaller, and the weight shrinks in proportion, many other uses are found for mobile radio. As long ago as three years back, small ascending balloons were equipped with short-wave radio transmitters which weighed less than two pounds complete and which were used to send information back to earth while the balloon ascended many miles aloft.

Another new use for mobile radio was recently found in England where traffic during the horse races was regulated by means of radio. When certain roads became crowded by too much traffic, as always happens in these cases, radio-equipped traffic policemen on horseback received certain information which enabled them to re-route traffic over other roads until such time as the traffic congestion was cleared. Similar means are used in the United States where during heavy Sunday traffic, an airplane overhead watches the congested roads and by radio directs traffic men on the ground to re-route, for the time being, long lines of automobiles into other roads in order to disentangle traffic. Even a bicycle will readily accommodate a transceiver; this apparatus, though, is particularly applicable to motorcycle policemen, most of whom at the present time have not the recognized advantages of radio equipment.

Already experiments have been made to equip special policemen and detectives with mobile ("pack") radio equipment. Such sets weigh not much more than a pound! When sets have been perfected still further so that they do not weigh more than a half-pound, or thereabouts, it is quite conceivable that entire police forces will be radio equipped, which will be another milestone in the progress to combat crime. If there is one thing that a policeman needs, it is instant information. Thus arrests can be made while the crime is still in progress.

A unique as well as an amusing application of mobile radio was demonstrated in this year's Easter parade on Fifth Avenue, N.Y.C. The National Broadcasting Company had one of their announcers equipped with a portable transmitter which was built into a silk hat. The announcer, dressed in the latest fashion, mingled freely with the Easter-parade crowd and spoke to the vast radio audience via a small microphone. Most people in the parade were, of course, not aware of the fact that here was a perambulating radio station! The range of this particular set was only about a half-mile. A receiver was installed in NBC'S automobile which trailed the "silk hat radio" at a short distance. This car re-transmitted the talk of the walking announcer to the broadcast studio, from whence it was put on wire lines and then broadcast in the usual manner. Our "G-men" could apply this idea.

Not so long ago David Sarnoff, President of The Radio Corporation of America, in a talk with the writer predicted that *sometime in the future all of us will be wearing wrist-watch radio sets*, by means of which we will be in instant communication with the rest of the world—it matters not where we are. You will talk into this tiny "radio"—which will not be much larger than your watch—and by pressing a button the microphone will become a tiny loudspeaker, and you will listen to the voice of your wife or your children as the case may be! All of this will probably be done through the instrumentality of *short waves*.

An entire new industry will be built around such new uses of mobile radio, and as far as this observer is concerned, we have not as yet even made a beginning!

THE RADIO MONTH



(Plainfield Courier-News)

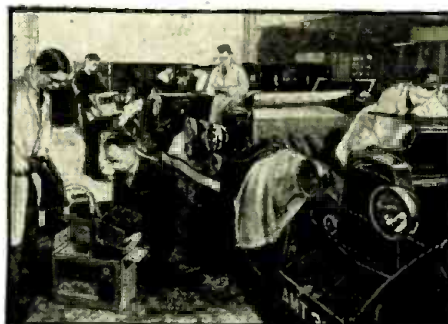

Left, Nelson G. Haas, W2GY, Plainfield, N. J., who "cut out interference" for G. B. Coleman, W8FRC, Johnstown, P. A., in flood rescue work. Above, The first London auto-radio garage.

RADIO IN THE FLOOD ZONES

AS usual in cases of emergency, amateur radio "came through" with flying colors in the floods in Eastern and Central states, last month.

Numerous cases have been reported of amateurs making contact with individuals in the flood areas and relaying messages to relieve the uncertainty in the minds of relatives and friends of those affected by the rising water.

One ham, Gerald Coleman, W8FRC, was the sole means of communication for many hours between hard-hit Johnstown, Pa., and the outside world.

Broadcast stations in the flood areas were shut down when the electric power went out—station KDKA set up emergency battery power supplies. Station WLW maintained 24-hour service during the crisis and accomplished much in gathering Reserve Officers—aiding the Red Cross and warning of the pollution of the water supplies.

It was stated that hundreds of lives and millions of dollars of property were saved by timely radio warnings of the approaching flood water by broadcast stations and amateurs.

LEAGUE OF NATIONS RADIO PEACE PLAN

WHEN the League of Nations published the second revised text of the "convention for the use of broadcasting in the cause of peace" last month, only two of the great powers remained silent.

Twenty-five governments accepted the convention by which they would agree to halt any radio transmission inciting the population of another nation.

The two governments to remain silent are Germany and Japan. It will be remembered that the Reich has been conducting an intensive propaganda campaign in Austria! The U. S. objected on the grounds that our government has no power of censorship over broadcasting.

FIRST AUTO-RADIO GARAGE IN ENGLAND

AUTO radio in Europe has been advancing by leaps and bounds during the past year or two. The sets are thoroughly modern when compared to those manufactured in the U. S., having all the features of A.V.C., noise suppression, vibrator-"B" power, etc.

According to a report received last month from the Marconi Co., in England, the sale of sets has reached a point where mass installation set-ups are necessary and auto-radio installation shops of the type shown above are being installed in all the large cities.

WNYC WORTH A MILLION!

SEVERAL months ago, (in the March, 1936 issue) we pointed out in these columns that New York's station WNYC which was scheduled to be discontinued about a year ago was building a new transmitter to cost about \$54,000, with Uncle Sam footing the bill!

During the past month, fiery little Mayor LaGuardia revealed that New York had been offered nearly a million dollars for its radio station, but the Mayor will have none of it—he wants to "develop the station." And why not—as long as the WPA will supply the funds!

Another metropolitan radio station also stepped into the limelight last month. This is WHN which after a long wait received a permit from the F.C.C. to increase its power to 5,000 watts in the daytime. This makes WHN the largest independent station (except for WOR, WABC WJZ and WEAJ) in the New York area. And that means that this station will have its big chance to get commercials, in the afternoon.

Incidentally, WHN picked up several nice "medical" (?) accounts when the CBS cleaned up its ad. copy, several months ago.

RADIO TELEPHONE SAVES SEAMEN

VIRTUALLY every form of electrical communication was brought into play last month when the captain and crew of the trawler Fauci were rescued. The rescue involved the telephone, telegraph and teletype, marine radio-telephone and even an auto-radio receiver! "WIEP calling WOU . . . We have sprung a bad leak . . . we need assistance immediately . . ."

Captain Patrick McHugh was talking by marine radio telephone across 400 miles of storm-lashed Atlantic to Albert F. Coleman on duty at Green Harbor, near Boston. Coleman acknowledged the call, and requested the location of the Fauci.

Glancing at his chart, Coleman determined that there were no vessels near the Fauci equipped with radio telephone and he transferred the call to Coast Guard headquarters in Boston.

The Coast Guard sent the SOS out by radio telegraph in the hope that some vessel near the Fauci might hear and go to her assistance. The cutter Cayuga, heard and could probably reach the Fauci in 24 hours. "Doubt if we can last that long," replied Capt. McHugh.

As the afternoon wore on, news spread by telegraph, teletype, newspaper headlines; and even broadcast stations interrupted their programs to flash the word across the country. Charles M. Fauci, owner of the vessel on his way to New York, picked up the announcement on his car radio set and tried to charter a seaplane to go to the aid of the trawler, but shortly came the encouraging news from the Boston Navy Yard station that the trawler Lemberg had reached the Fauci and was standing by. All hands were saved!

The marine radio-telephone is seen in the insert. Picture shows Green Harbor station.



IN REVIEW

Radio is now such a vast and diversified art it becomes necessary to make a general survey of important monthly developments. RADIO-CRAFT analyzes these developments and presents a review of those items which interest all.

RADIO MUSICIANS WIN RAISE

THE National, Columbia and Mutual broadcast networks agreed last month to meet the demands of the American Federation of Musicians for wage increases and shorter hours for musicians and music arrangers.

Under the terms of the new agreement musicians employed on commercial and sustaining programs who formerly worked 33 hours a week will now put in 30 hours and with no loss of salary. Furthermore, they will work 5 out of 8 consecutive hours instead of 5 out of 10 a day. Musicians engaged in commercial and sustaining programs will be paid \$140 minimum, while those employed only on sustaining programs will receive \$100 on the basis of a 30-hour, 6-day week.

Music arrangers will receive \$115 and copyists will receive \$65 for a 35-hour week.

CENTENNIAL OF THE DEATH OF AMPERE

THE year of 1936 is being commemorated throughout France as the centennial of the death of André-Marie Ampère—the famous physicist and mathematician.

The work of Ampère in the fields of electricity and physics is well known to all students of these subjects. His discoveries greatly aided the development of radio communication by furnishing the background of electrical knowledge upon which this science has been built.

A special postage stamp was placed in circulation, last month, in France, to honor the memory of this great scientist.

The new memorial stamp in use in France to commemorate the death of André-Marie Ampère.



The radio-controlled tractor which demonstrates the possibilities of controlling heavy vehicles entirely by radio! The farmer of the future may have use for them!

RADIO CONTROLLED TRACTOR!

ACCORDING to a report received last month from a well-known manufacturer of tractors and farm implements, the farmer of the future will be able to plow his ground and reap the harvest without leaving the comforts of his front porch.

An experimental tractor which is entirely controlled by radio has been made, as a demonstration of the possibilities of remote control for farm power tools. While it is not expected that such implements will be put to practical use in the near future, the demonstration shows the possibilities of mobile radio!

PHONE-TELEVISION IN GERMANY!

GERMANY opened to the public the first long-distance television-telephone service in the world, last month!

The television line, linking Berlin and Leipzig was inaugurated by the German Postal Ministry in connection with the opening of the Leipzig spring fair.

It is reported that recognizable images on the 8-in.-square surface of the screen, somewhat similar to the images of the early motion pictures, appeared during the "visible" conversation. A special cable is used to carry the television impulses—to keep the communication private, according to the reports received. It is understood that a radio tie-up is also being tried.

A tariff of \$1.40 for a 3-minute visible conversation.

It is reported that a similar line between London and Manchester in England will be in operation soon.

In the U.S., the F.C.C. agreed to certain changes in the regulations covering the installation of the proposed coaxial cable from New York to Philadelphia and the decision is now in the hands of the A.T.&T. It is "expected" that construction will start soon!



A simple device for speaking on a light beam being demonstrated by Dr. J. B. Kramer. It consists of only a battery, flashlight and microphone!

NEW LINE-OF-SIGHT COMMUNICATION

A NEW system for communicating over short distances which is not only extremely simple but also has the advantage of being practically secret was demonstrated by Dr. J. B. Kramer of the G.E. Co. last month.

The system is an adaptation of the modulated light beam systems which have found many interesting applications in the past few years.

This simple device consists simply of a flashlight and a microphone joined together and fed from the same battery. The flashlight bulb is a low-current type. As you speak into the microphone, the light beam varies in intensity.

A photo-cell is then used to translate the varying light beam back into audible sounds at the receiving end and an amplifier builds up the volume.

MUSIC FIGHT FLOURISHES

THE bitter fight between the National Association of Broadcasters and the American Society of Composers, Authors and Publishers has now entered the House of Representatives, via the Patents Committee.

James W. Baldwin, managing director of the N.A.B., told the Committee last month that the industry's gross receipts last year were \$87,523,848, of which \$2,995,000 went for the use of musical works on which copyrights were held by the A.S.C.A.P.

He said that he had no quarrel with the amount paid but that the method of payment amounted to the "exercise of a monopolistic power which denies us the right of bargaining."

And in the meantime, Warner Brothers music publishing subsidiaries—which concern, by the way, is back of the entire fight—hailed 25 more broadcast stations into court for using their music!

To top matters off, Harry Warner
(Continued on page 759)



Fig. 1, above; Fig. 2, below. "Car"-radio ideas.



NEW IDEAS IN "CAR" RADIO

Anyone interested in car radio will find considerable enjoyment in reading about these new utilitarian ideas in the car-radio field.

H. G. McENTEE

WITH THIS issue we present several new ideas for consideration by users and makers of car-radio equipment.

The first is that depicted on the cover—the use of radio by reporters. These "mobile reporters" will be able to send spot descriptions of various happenings to their editors, saving much time and enabling them to be right at hand when anything out of the ordinary is taking place.

The ultra-short waves will probably be used for such service, since they offer reasonably certain communication over moderately short distances, such as the area of a city. Also antenna equipment may be compact and efficient, and many such stations may be used throughout the country without crowding.

In Fig. 1, we have an idea for the Service Man which will save much time and labor in running back and forth to

the shop. Also it can be used to the greatest advantage by the Service Man who has no facilities for a shop into which he can run cars for work on the radio equipment, and which have, therefore, to be serviced at the curb.

The apparatus on such a "tea wagon" will naturally vary according to individual tastes, but there should be plenty of room for all tools needed, a complete set tester and analyzer, vibrator tester, tube tester and so on. A heavy-duty storage battery would furnish power for all purposes, including an arrangement for soldering, such as that described on page 716 of this issue. The equipment will then be completely self-contained and may be rolled anywhere it is convenient to work on the car.

Motorists who use their car for camping trips often hesitate to use the car "radio" for fear of running the battery down so low it cannot
(Continued on page 739)

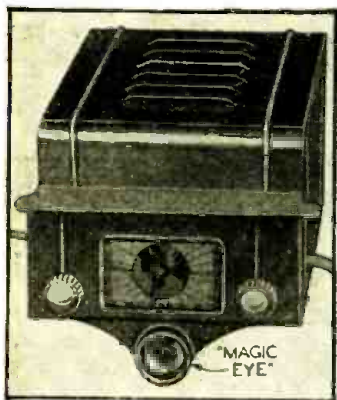

Fig. A. A set using a tuning "eye."

Automatic Model A1. The most novel feature of this receiver, shown in Fig. 1A, is the use of the cathode-ray or so-called "magic-eye" tuning tube. This is one of the first sets to come through with this refinement. The "eye" is mounted on a detachable bracket so that the set may be obtained with or with-

LATEST CAR-RADIO RECEIVERS

A great many improvements that have been effected in radio receiver design are indicated by these descriptions of the latest sets for the car-radio owner.

out, as the customer so desires. The front panel is very modern and is installed so that it is just under the edge of the dash. The speaker is on the underside of the case, and is entirely dust-proof. (Diagram on page 714.)

Philco Model 818. This set, Fig. B, is supplied with 2 speakers to insure even distribution of sound throughout the car. One is mounted in the set, while the other goes above the windshield. The compact control unit has a unique dial arrangement which allows it to be

mounted either vertically or horizontally. The receiver case with its modernistic speaker grille is compact enough to fit any car. (Diagram on page 715.)

Bosch Model 737. Metal tubes are used throughout in this set. Fig. C, which is equipped with a speaker that can be mounted either over or under the upholstery of the header bar. The set case measures only 8 3/4 x 8 3/4 x 6 7/16 ins. deep, with pleasingly rounded corners. (Diagram on page 714.)

(Continued on page 739)

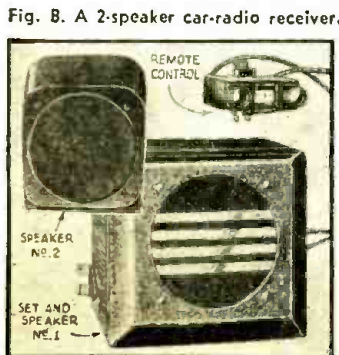

Fig. B. A 2-speaker car-radio receiver.

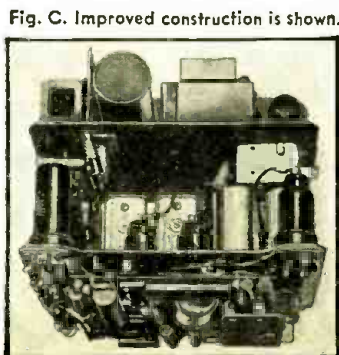
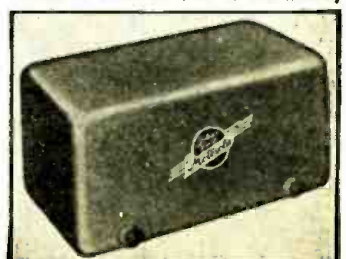

Fig. C. Improved construction is shown.



Fig. D. Metal tube car-radio set.

Fig. E. A modernistic car set. This receiver installs over the steering post. (An "eliminode" for eliminating ignition noise plugs onto the back of the chassis of some models in this make.)



NEW CAR-RADIO DEVELOPMENTS

In this article the author acquaints the reader with important advances in the field of automobile radio.

R. D. WASHBURNE

CHOICE OF SPEAKERS

(1034) One of the new, 1936 car-radio sets, here illustrated, may be used with any one of 3 speakers. The chassis has a built-in speaker, A, which is normal equipment. If speakers B or C are used, the original set speaker is removed and a cover-plate, shown, is substituted in its place. (Only one reproducer may be used at a time.) Plugs make the change-over a simple one. Reproducer B is a dash speaker of larger size than that contained in the receiver case. Speaker C may be mounted in the rear of the front seat, on the header, or any place where a very compact unit is required. (Circuit on page 714)

CONCEALED SPEAKER

(1035) While ear-level reception is not new (See June, 1935 *Radio-Craft*) the latest kink in this line is the use of entirely concealed equipment. Here we see speakers which are well baffled, and highly efficient, yet they are entirely out of sight, and no one can deny that this adds considerably to the appearance of the car interior. The light cloth covering does not impede the sound but acts only to hide the reproducer. In this particular installation, the 2 reproducers are used together, and both operate at the same time.

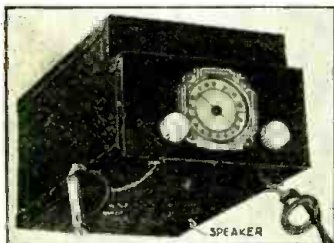

A set for under the dash. (1039)

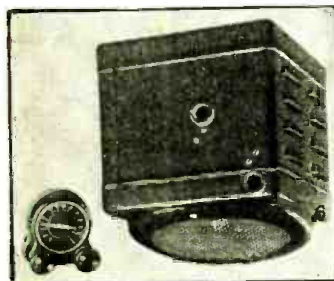

Above. Under-dash, tilted-speaker set. (1040) Below, a "Jiffy" set mounting. (1041)

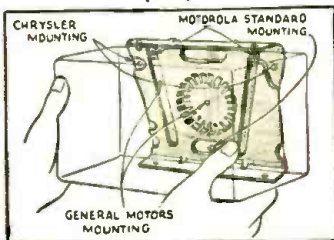

Either 6- or 8-in. units may be had for mounting under the cowl, while the extra unit may be either an overhead or a rear-seat speaker. Complete cable connections with a plug are included in the equipment.

MODERN VIBRATORS

(1036) Modern vibrators are no longer the tricky, uncertain units they were only a few years ago. They are now sturdily built of the finest materials. Two of the most recent models are illustrated.

That shown at A is a synchronous vibrator, and has many special features. The double-stack (1) construction uses porcelain bushings and provides an absolutely rigid base for the reed. Only the highest-quality dielectric is used to insulate the reeds (2). The reed is connected to the frame by a phosphor bronze center strap (3). Monel metal side reeds (4) are used to insure permanence of adjustment, since this is the only material that can stand the heat and hammering these parts are subject to in operation. The center reed (5) is of 3-piece construction, the 2 outer pieces holding the contacts. Thus the main center piece will have no holes in it to cause breakage. The contacts (6) are of vertical-grain tungsten, a construction which is more expensive, but gives far longer life. The actuating coil (7) is a true solenoid in preference to the type which is wound on a flat strip, as the former gives higher efficiency and longer life. The steel frame (8) provides an efficient magnetic path.

The construction of the non-synchronous type at B is even heavier, since a cast-iron frame (2) is employed. A double shell (1) with sound insulation between sections provides quiet operation. Still another shell (9) permanently seals the unit. The same stack construction is used with a porcelain bushing (8), but in this type of vibrator only a single stack is needed. The sealed vibrator unit is floated in molded sponge rubber (12). The other features are the same as in the synchronous type, with the solenoid coil (3), 3-piece center reed (4), monel metal side reeds (5), vertical-grain tungsten contacts (6) and other points of superior construction which insure a trouble-free unit.

NOISE ELIMINATOR

(1037) This unit was described (and circuit shown) in the June,

Photo and circuit below. Front- and rear-wheel static collectors are important advances in securing noise-free radio reception in a moving car. (1042)

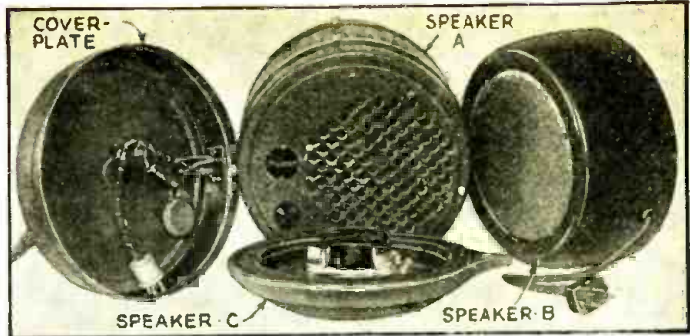

Above. This car-radio set uses one of 3 loudspeakers. (1034)

1935 issue of *Radio-Craft*, but the improved edition is even more efficient, although it works on exactly the same principle. The case is of cast metal and each element of the circuit is in its own compartment. No separate "noise pick-up antenna" is needed since the "noise voltage" for balancing-out is taken from the battery lead to the set. As the battery lead passes through the unit it is completely filtered to remove all trace of noise before it reaches the receiver circuits. Several adjustments are used to secure the most efficient setting.

This equipment works on the principle that noise which is picked up by the car antenna is balanced out by the same noise, taken from the "A" lead in the "eliminode." The 2 are out of phase and so, when balanced by means of adjustments in the unit, they are exactly equal, and thus no noise reaches the input circuits of the receiver.

NEW FORD RADIO

(1038) The neatness of this installation may be seen in the illustration. It is a radio set of the 2-unit type. The set chassis fits directly in back of the steering column and is shaped so that the driver's knees will clear the housing; the speaker being placed back of the header bar. The control unit fits within the space formerly occupied by the ash tray at the center of the dash board. The speaker is invisible, and thus the interior appearance of the car is not marred by its use. Many chassis improvements have been made over the set supplied last year. Higher sensitivity, and a decrease of external noise pick-up are claimed. A continuously-variable tone control is now employed. As a rule, it is not necessary to install spark plug suppressors when this improved receiver is used.

THIS SET'S SPEAKER POINTS DOWNWARD

(Autocrat Radio Co.)

(1039) This set illustrates the use of a speaker facing downward toward the floorboards. No separate control unit is needed for this type of set, since all controls are self-contained. This results in a simple, compact installation, and leaves the maximum of room below the set, so that the rider's feet will not be crowded.

(Continued on page 739)



Above and below. Concealing the reproducer is the latest "trick" in new car-radio installations. (1035)

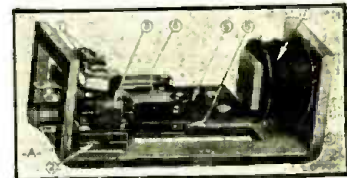
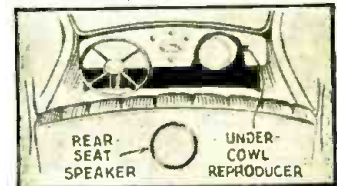

Above, A; below, B. Modern synchronous and non-synchronous (respectively) "vibrators" are vastly improved over earlier types. Note the suspension in sponge rubber, 12. (1036)

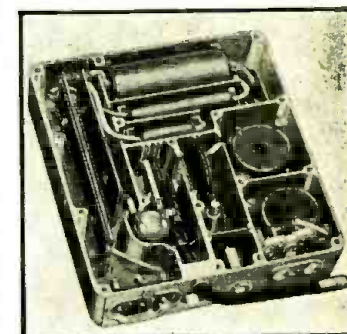
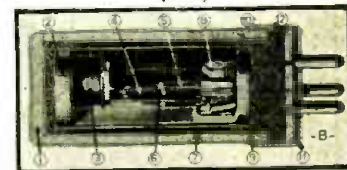

Above. New, improved "eliminode." (1037)

Below. Ford's car-radio set. (1038)

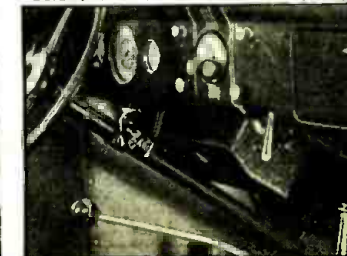

DIAGRAMS OF THE NEWEST CAR-RADIO RECEIVERS

The trend of design of the new receivers can be seen most readily by an examination of the actual circuits.

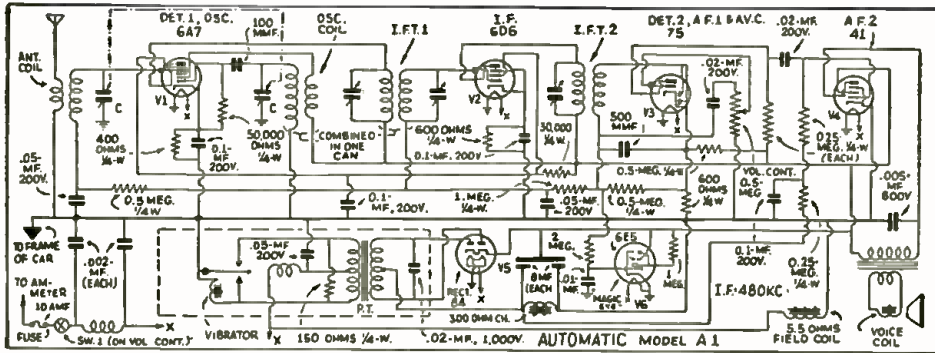

(1) Automatic "Magic Eye" Model A1. A novelty of this set is its "magic eye" 6E5 tuning tube. The set may be had with or without this feature. Operation is possible in most cases with only a generator condenser and a distributor suppressor. The set is mounted directly below the dash, and no remote control is used. Alignment of the set is done at 1,400 kc. Installation is made with 2 screws fastened to the dash and a single heavy bolt at the rear, through the motor compartment bulkhead. For installation in the Willys 77, a roof antenna of about 10 square ft. of copper screen should be used. Voltages: Plate—V1, V2, 220; V3, 120; V4, 200. S.-G.—V1, V2, 95; V4, 220. Cath.—V1, 3; V2, 3.7; V3, 1.3. Bias of V4, 14 V., drop across the "B" choke. (Photo on page 712)

(2) Bosch Models 736, 737, 738. These sets are the same except for the speaker equipment. The model 736 uses a self-contained speaker, model 737 is used with a header-type speaker, and 738 has a separately mounted dash speaker. Various makes of cars will require different treatment for noise suppression, but complete instructions are furnished with the set. The tubes used in this set are quick-heater types. The tone control knob is located on the side of the receiver case. The antenna cable is cut to a specific length and should not be shortened. Any excess may be coiled up out of the way. An antenna loading is included in this cable. This set may be used with any type of car antenna. The new grid-bias cell is used in this receiver and under normal use will not need replacement during the life of the car. The 0Z4 rectifier tube is similar in action to the old BH rectifiers, but is much improved. Voltages to be found in this set will vary rather widely according to the condition of the battery and vibrator, but the normal high voltage is around 240 V. A 20 A. fuse is used for protection of battery. (Photo on page 712)

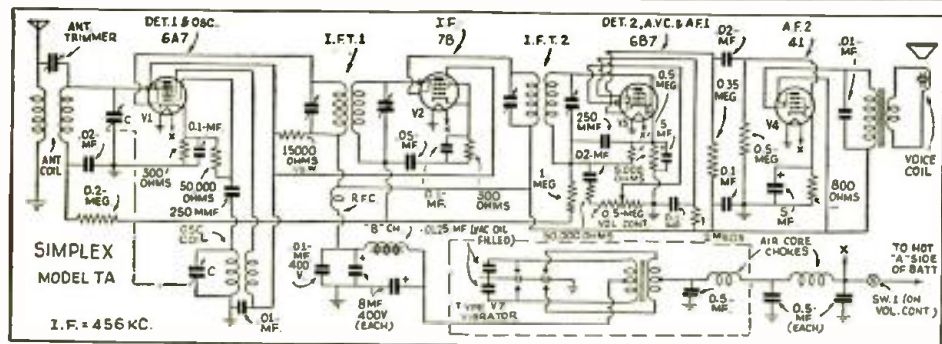
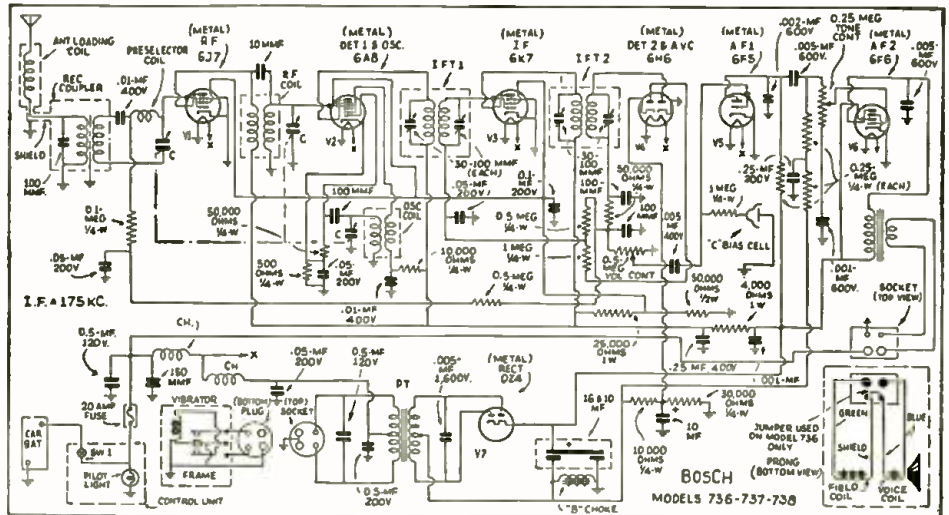

(3) Simplex Model TA. This is one of comparatively few using the synchronous type of vibrator, which eliminates the necessity for a rectifier tube. If the car battery is grounded on the negative side, the vibrator must be removed from its socket and turned half-way around before inserting. It is normally shipped for use with the ground on the positive side. An antenna trimmer is used to adjust the set to the most accurate balance with the particular antenna used. The trimmer is located at the bottom of the cabinet under a small plug. It should be adjusted with the set in the car, and connected to the car antenna. Ordinarily, only a distributor suppressor is necessary with this car, the battery input being well filtered.

(4) Fada Model 266 Motaset. This set may be used with a self-contained speaker, a roof or other outside speaker, or it may be used with dual speakers. The plug connections of the different types are shown at the bottom of the diagram at right. The input "A" leads are very completely filtered, to keep out ignition noise. The antenna input transformer is of the iron-core type, and this unit raises the sensitivity of the set to a considerable degree. Two of the new metal tubes are used, including the 6Q7 double-diode triode, which is closely equivalent to the 75. Voltages at tube prongs are: Plate—V1, 162; V2, 160; V3, 162; V4, 107; V5, 226. S.-G.—V1, 68; V2, 66; V5, 236. Plate current: V1, 3; V2, 3.4; V3, 2.9; V4, 0.3; V5, 19; V6, (total) 37. These readings were taken with a 1,000 ohm-per-volt meter and are not indicative of effective voltages. The readings were taken with a supply voltage of 6.0, and the current was 5.6 A. The I.F. transformers are to be aligned at 175 kc., while the gang trimmers are set at a reading of 1,500 kc. The oscillator series trimmer must be aligned at a frequency of 600 kc. The "hot A" lead has a fused connector for protection. (This is the circuit of the receiver shown at upper right, page 713.)

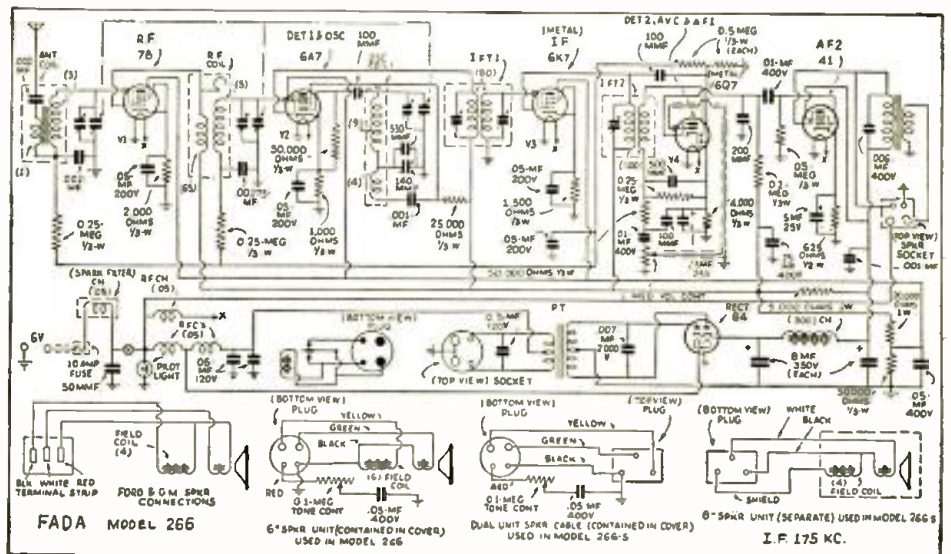

(5) Philco Model 818. When this set is used in a car having a top antenna, under-car antenna, spare-wheel antenna, or any other having low relative capacity (50 mmf. to 450 mmf.), use connector plug in "A." For antennas of high relative capacity, such as metal insert top antenna, insulated door, insulated trunk cover (450 to 2,500 mmf.), use condenser plug in "B." Adjustment frequencies are: 1,550 kc. and 580 kc. for R.F. and detector. The antenna adjustment should preferably be made with the set in the car and attached to the car antenna. Iron-core I.F. transformers are used and add greatly to the sensitivity of the receiver. All leads out of the receiver case are very completely filtered. Continuously variable tone compensation is available. The input lead from battery is fused. The manufacturers prefer not to give complete voltage data, since voltages vary widely with different conditions, but with a fully-charged battery, the high voltage is about 180 to 220 V. (Photo on page 712.)

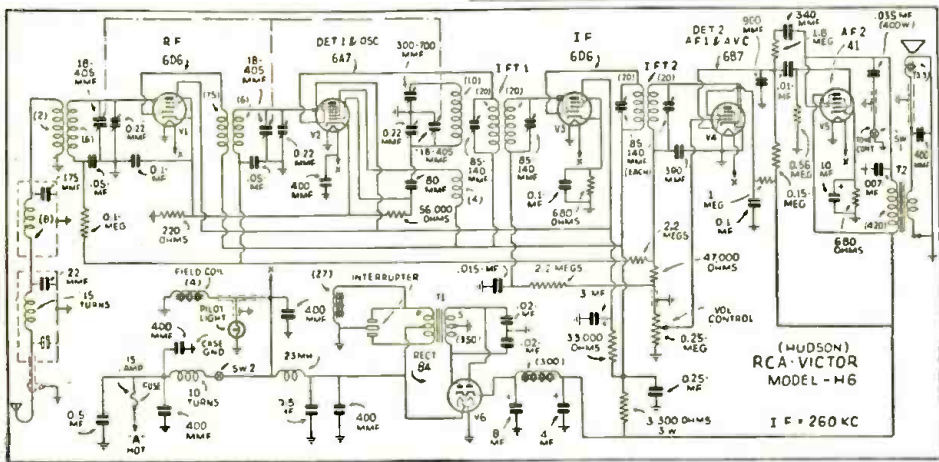
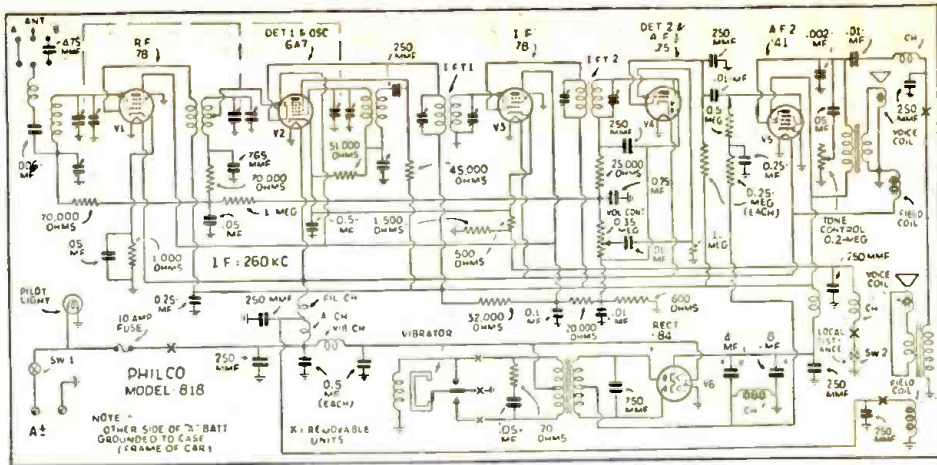

(6) RCA Victor Model H-6. A special antenna circuit is used which contains a band-pass filter, affecting a sharp reduction of frequencies out of the band of 540 to 1,660 kc. "Hot" spots of ignition interference on the chassis have been carefully located and grounded. A single-position tone control is used. There is a total of 7 tuned circuits in the R.F. section of the set. The reproducer is a separate unit. Alignment frequencies are: 1,400 kc. for ant. and det. coils, and 600 and 1,400 kc. for osc. coil. Undistorted output is 1.75 W. and maximum is 3.5 W. Battery current drain is 6.55 A. A control panel mounts directly in the dash of the car. Set size is 6 1/2 x 9 1/2 x 6 1/2 ins. high. Voltages: Plate—V1, 205; V2†, 205; V3, 205; V4, 90*; V5, 235. S.-G.—V1, 82; V2, 82; V3, 82; V4, 20*; V5, 245. Cath.—V1, 2.5; V2, 2.5; V3, 3; V4, 0; V5, 20. *Cannot be meas. with ordinary meter. †V2, osc. plate, 205.

(7) Motorola "Golden Voice" Model. This set contains the "magic eliminode" circuit, which not only filters out motor noise, but balances the noise out of the antenna lead, so that suppressorless operation is possible on almost all cars. (See *Radio-Craft*, Car-Radio Number, July 1935.) This unit also incorporates an antenna tuning circuit to properly match and tune the set to any type of antenna. Besides the tone control and the normal volume control, this set has a variable sensitivity control, which is mounted on the front of the case. The input tuning coil of the R.F. stage is of the iron-core type. The output stage is of the class AB type, with a separate bias rectifier system, using a 6H6 with an independent filter. The bias from this source is used on both A.F. stages. The circuit herewith published is the latest and supersedes all others. Delayed A.V.C. is employed and is affected by the use of V4 in conjunction with V5. Do not connect any condenser from the hot "A" lead to ground as this would nullify the action of the eliminode. All necessary filtering is contained in the latter. Current drain from a fresh battery is 8A., producing 260 V. (Photo on page 712.)

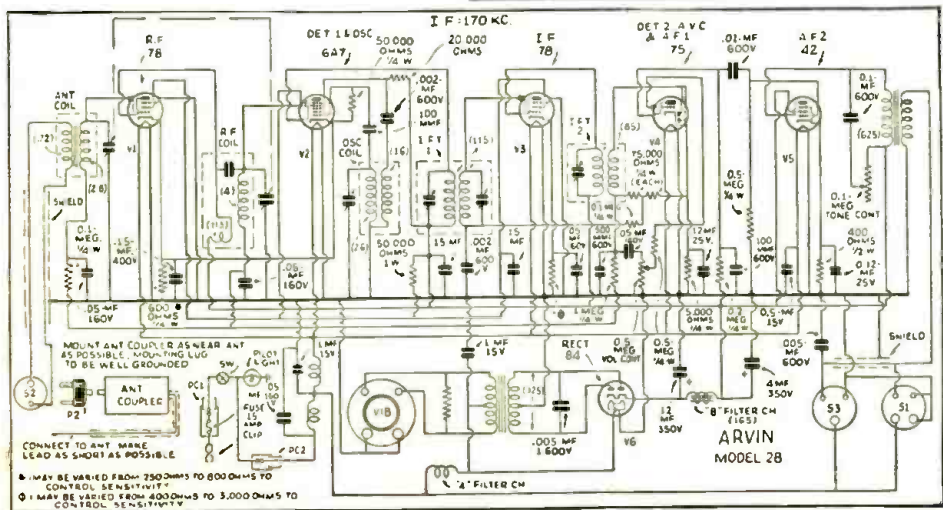
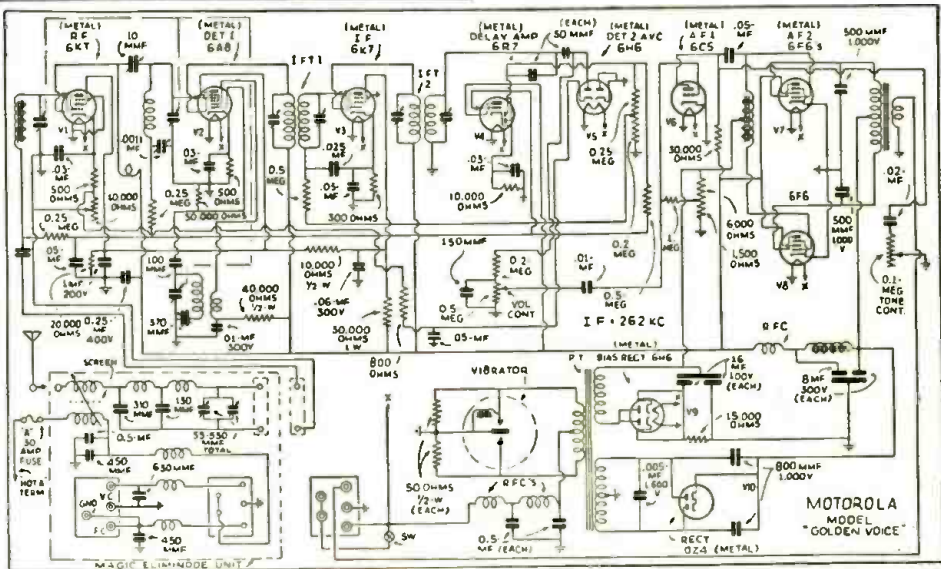

(8) Arvin Model 28. This set may be had with either enclosed or separate speaker. Also matching dash control panels may be had, or the set may be equipped with a streamline steering-column control. A complete noise filter is built-in. Special iron-core antenna tuning system consists of two couplers assuring high gain on the smallest antenna. Full A.V.C. holds signal steady, while continuously-variable tone control covers complete tonal range. The set must be balanced at 1,400 kc., and checked for accuracy at 1,000 and 600 kc. Tubular fixed condensers are firmly fastened to chassis, eliminating broken leads. Copper plated chassis and case with locking snap-on covers add to stability and ease of servicing. Only one hole to drill to install chassis in any position, back or side. Tuning condenser is rubber mounted and has an improved high-ratio vernier drive, enabling the greatest possible ease of tuning. Voltages: Plate—V1, V2, V3, 235; V4, 120; V5, 230. S.-G.—V1, V2, V3, 90; V5, 235. Cath.—V1, V2, 4; V3, 2.3; V4, 1.6; V5, 16. Osc. plate, V2, 160.

SHORT-CUTS IN RADIO

FIRST PRIZE.....\$10.00
 SECOND PRIZE..... 5.00
 THIRD PRIZE..... 5.00
 Honorable Mention

EXPERIMENTERS: Three cash prizes will be awarded for time- and money-saving ideas. Honorable mention will be given for all other published items. Send in your best "kinks"!

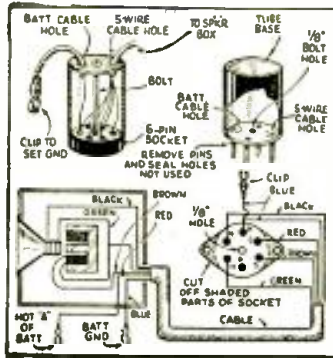

Fig. 1. Handy service speaker.

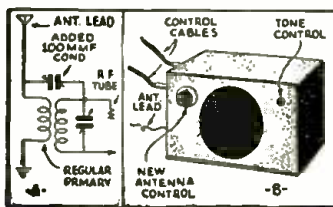

Fig. 2. Tuned input circuit.

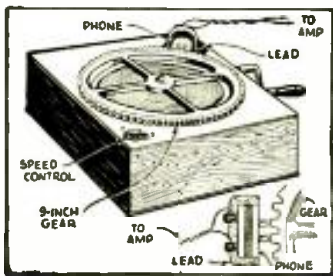

Fig. 3. Tone source.

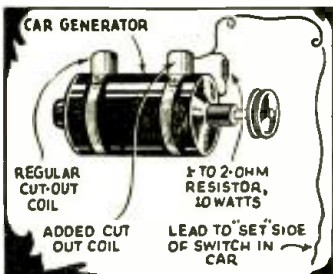

Fig. 4. Increasing charging rate.

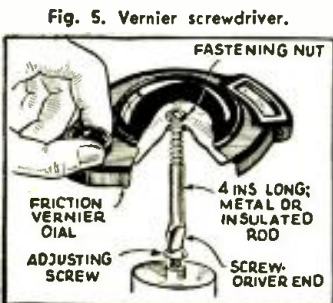

Fig. 5. Vernier screwdriver.

FIRST PRIZE—\$10.00
EXTERNAL, "SERVICING" CAR-RADIO SPEAKER. The 1936 Philco radio sets for Ford cars are used with a speaker which is installed under the header plate. If the set has to be removed for service, it is a long job to take out the speaker. In such cases the speaker shown in Fig. 1 will be found very handy, and may be made up in a short time. Any small speaker with a 6 V. field may be used, with a cable and special plug. The plug is made from a discarded tube base, with the prongs sawed off, and a molded-type 6-prong socket. The latter is cut down as shown, and bolted to the tube base, after connections have been made to the cable.
 For auto sets that have other plug or socket arrangements adapters may be made.

A. E. PASBRIG

SECOND PRIZE—\$5.00

INCREASING CAR-RADIO SENSITIVITY. Some makes of car receivers have a small primary on the antenna coil. This primary is usually designed for average performance with all kinds of antennas, and it was thought that improved performance could be obtained by some sort of tuning arrangement. That shown at Fig. 2A was tried and worked to perfection. The 100 mmf. condenser, small dial and knob were mounted on the front of the receiver case as shown in Fig. 2B. Some sets may not have room on the front for the condenser, but since it does not have to be changed often it can just as well be mounted in any other location.

This arrangement greatly increases the response at the high-frequency end of the band, but the increase may be noted over the whole range. It will probably be found that the setting is not quite the same for opposite ends of the band, but a good average may easily be worked out.

E. G. McCOLLUM

THIRD PRIZE—\$5.00

CALIBRATED AUDIO-FREQUENCY ALTERNATOR. Having need for a source of A.C. of known frequency, I made a simple machine from a portable phonograph, the general layout being shown in Fig. 3. A 9-in. gear wheel is mounted on the turntable, and a (Brandes) headphone unit is used as a pickup. The phone is used with-

out the cap and diaphragm, and is mounted on a heavy lead block so that it may be moved for best position. The pole pieces are set so that they are parallel-to, and just clear, the gear teeth, and they must be even with any 2 of the teeth.

The speed of the turntable is 80 r.p.m., so 12,000 teeth pass the pole pieces per minute, or 200 per second, giving a 200-cycle note. The output may be amplified to any level.

CAL BRAINARD

HONORABLE MENTION

CAR-RADIO "A" DRAIN COMPENSATOR. When the car is in motion, this device increases the charging rate of the generator 5 A. when the car radio is turned on. A second cutout is used, and, when connected as shown in Fig. 4, operates when the car radio switch is turned on. This shorts out the 2-ohm resistor in series with the field coil. With most generators this will raise the charging rate the required amount. The armature is adjusted to spring back when the load of the receiver is removed.

HAROLD G. RUSSELL

HONORABLE MENTION

VERNIER SCREWDRIVER. Some adjustments which have to be made with an insulated screwdriver are very critical. The device in Fig. 5 enables one to make these with the greatest ease and accuracy. The dial is a "K-K" unit and a 4-in. piece of rod, either metal or insulation, is fastened in the large rotating member of the dial. The end of the rod is filed flat to fit into the screw slot. This tool cannot be used on very tight screws unless the dial friction is exceptionally great.

(NO NAME)

HONORABLE MENTION

FUSING THE POWER LINE. This attachment will save the Service Man much embarrassment by preventing an accidental blowing of fuses in the customer's home. As seen in Fig. 6, it is simply a box with 2 sockets for fuses and 2 toggle switches to short the fuses if they blow. (Use the self-restoring fuses mentioned in past issue of *Radio-Craft*, and you will not need these switches—which should be used with great circumspection.—Editor) An ordinary outlet is also included. Should any shorts occur in the trouble lamp, tube tester, or the

(Continued on page 742)

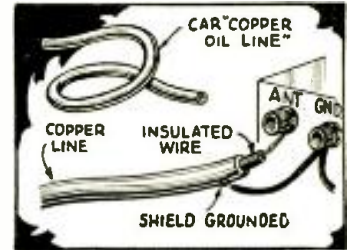

Fig. 13. Cheap shielding.



Fig. 12. Socket prong cleaner.

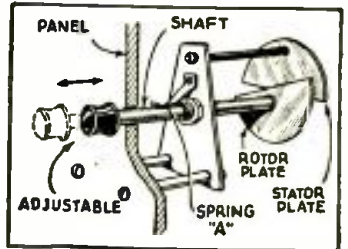

Fig. 11. Wide-range trimmer.

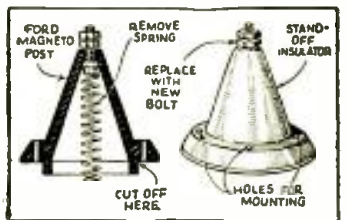

Fig. 10. Stand-off insulator.

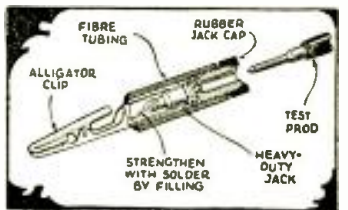

Fig. 9, above. Removable clip.

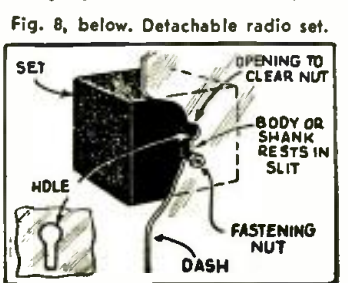

Fig. 8, below. Detachable radio set.

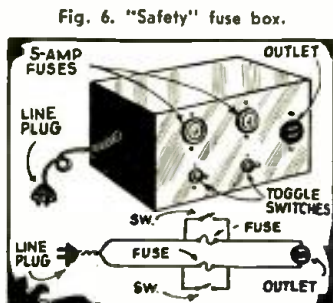

Fig. 6. "Safety" fuse box.

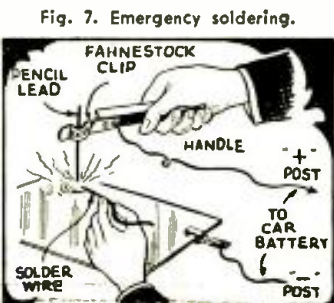

Fig. 7. Emergency soldering.

HOW TO MAKE A 2½ TO 555 METER DX SET

"R-S-R" (Regeneration-Super-Regeneration) plus a wave range of 2½ to 555 meters are the features of this set.

A. J. HAYNES

SUMMER, the season when the high-frequency bands come into their own, is at hand. Instead of looking forward to 4 or 5 months of heavy static and poor reception, as of yore, the 1936 model ether-wave explorer is overhauling his short-wave equipment and embarking, with eager anticipation, on another season of good short-wave reception.

The back of the set, removed from its cabinet.

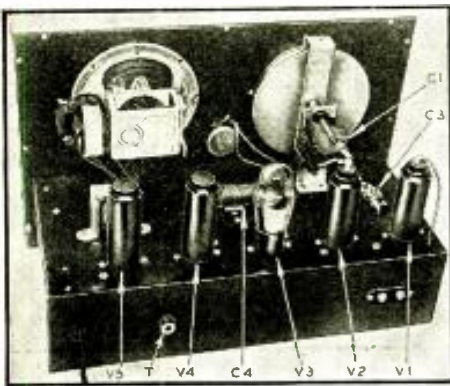

This year his scope of interest has been tremendously increased by the opening up of the *ultra-high frequency* bands. Some of the new chain broadcast stations, operating between 5 and 10 meters, are already on the air; phenomenal low power, long distance work, in the neighborhood of 10 meters, is an everyday occurrence, while the Summer is sure to see new DX records made on the 5-meter band. *Even below this, in the neighborhood of 3 and 4 meters, there is already considerable commercial activity—such as direct portable broadcasting of sporting events, etc.*

Obviously, short-wave reception no longer means "down to 16 meters," and a modern "all-wave" receiver, to justify its name, must extend from the top (550 meters) of the "old" broadcast band, on down to well below 5 meters.

BAND SWITCHING USED

The receiver described below is called the "R-S-R" because it combines *regen-*

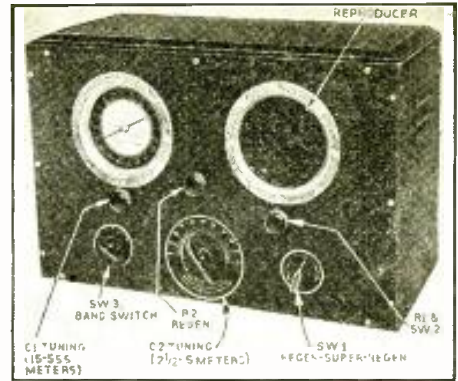

eration with super-regeneration. Its tuning range extends from 2½ to 555 meters, and it can be adjusted for any frequency over this entire spectrum.

To attain efficiency and stable tuning this range is divided into two sections, as follows:

- (1) From 555 meters down to 15 meters band switching is employed in
(Continued on page 744)

The under-chassis view showing the U.H.F. tuning unit and other components.

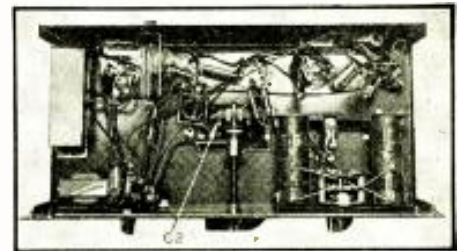

PUBLIC ADDRESS —A MISNOMER!

The fact that Public Address has long since exceeded the limits of its name is amply proven; a 7-W. amplifier gives "evidence."

PHILIP R. BAUS

THERE IS no question in the minds of those engaged in what is known as the Public Address field, that this name has outgrown its usefulness in covering the various angles of this business. As proof of this, the small, standard, portable 7-W. amplifier shown in the heading of this article will be used as the theme unit in this discussion. It is true that this unit possibly is constructed with a higher degree of flexibility than most standard amplifiers but it is still classed in the "low-priced" field and it serves a multitude of purposes—which proves the term "Public

The versatile amplifier which is the basis of this discussion. This amplifier with slight revisions of circuit and accessories has been sold for many unusual applications.

Address" as applied to this business is a misnomer.

"P.A." UNIT TECHNICAL DATA

The amplifier shown, is equipped with 2-position input for two microphones or phono. pickups. The unit has push-pull input for crystal microphones and phono. pickup, and one feature of crystal products is that two microphones can be paralleled or a crystal microphone and crystal pickup can be paralleled on the input. One interesting feature at this point is that a phono. unit equipped with a volume control can be paralleled with a crystal microphone producing the effects of a mixer. The over-all gain

is controlled by the gain control on the amplifier and the phono. unit is faded in or out at will with the volume control on this unit. While a standard 2- or 3-position electronic mixer is advised on the better installations, the above arrangement is possible where funds are not available for a mixer.

The amplifier is equipped with tone control. For dance bands and funeral parlors the "highs" are attenuated, while for detective systems, restaurant order systems, or outdoor use, the high response is necessary to meet both the sensitive pick-up requirements and "carrying" properties of sound projec-

(Continued on page 743)

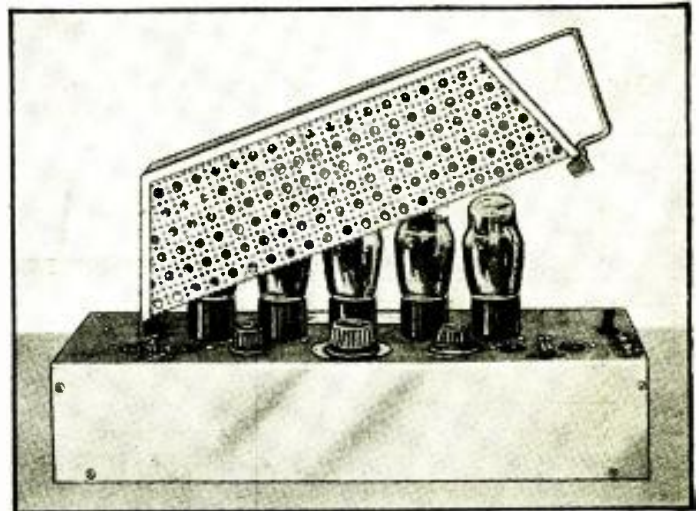

The chassis top, showing the tube complement.

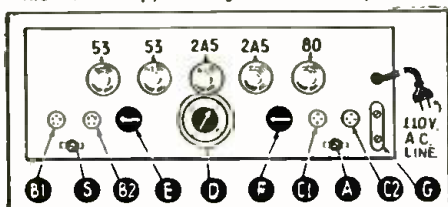

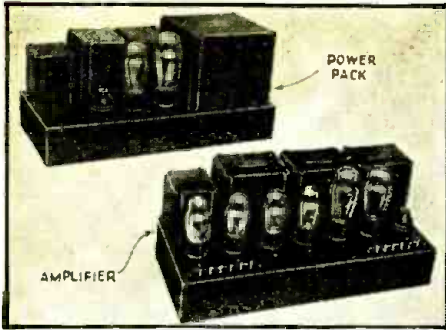

A PORTABLE HIGH-FIDELITY P.A. AMPLIFIER

A few of the outstanding problems in the design and operation of high-fidelity amplifiers are discussed.

I. A. MITCHELL

THE USE OF A.F. amplification systems for sound reinforcement and sound projection has increased tremendously over the past few years. New uses of this modern electrical voice are being discovered daily.

In addition to P.A. systems, we now have such A.F. applications as the reproduction of clock chimes and carillons over large areas; aiding the docking of vessels; announcing and call systems; inter-vessel communications; advertising from airplanes, dirigibles, boats and trucks; and the numerous other uses which we encounter, today, in modern cities. The value of amplification equipment designed for such purposes generally depends not on just the acoustical output, but on the *undistorted* acoustical output. This is particularly important at the present moment, when the public is being educated to high fidelity.

It is interesting to note, at this point,

what is meant by "undistorted output." For true high fidelity or undistorted amplification, a frequency range of at least 50 to 10,000 cycles must be transmitted; the harmonic content should not exceed 5 per cent, and the volume range

of reproduction must be approximately 70 db. For good results, whether in P.A. or home use, it is also essential that the volume level be sufficiently great to deliver satisfactory sound at
(Continued on page 746)

The circuit of the amplifier used as an example of correct design is shown below.

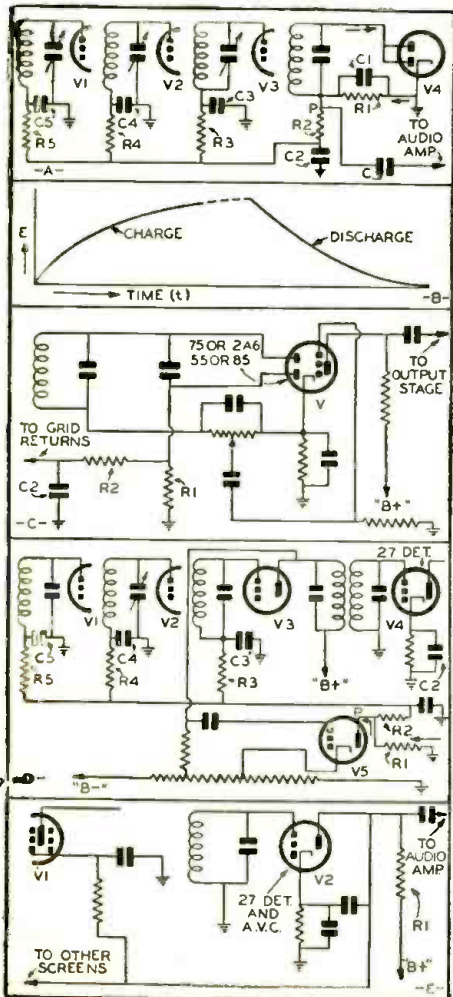
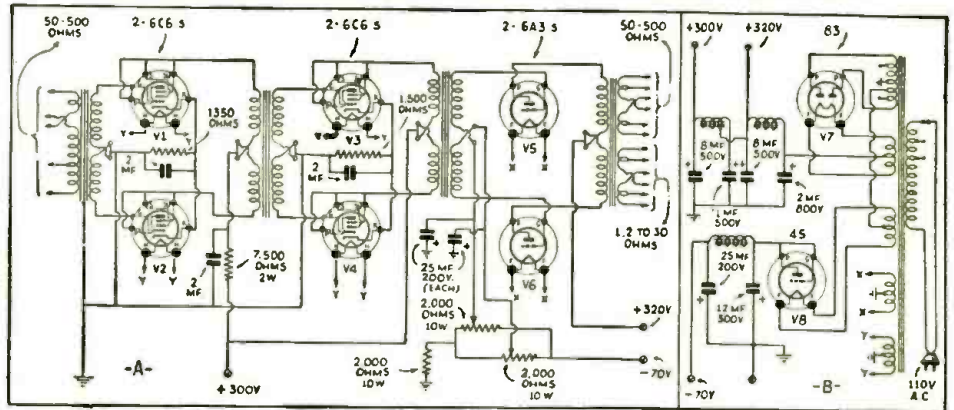

DESIGN DATA ON A.V.C. CIRCUITS

The design of A.V.C. circuits has long puzzled many radio technicians—here is the inside story.

PART I

THERE ARE numerous varieties of automatic volume control (or "A.V.C.") circuits, but all work on the same principle. It is, therefore, the purpose of this article to present the theory whereon the circuit is based which should enable the reader to understand all modern A.V.C. circuits.

The arrangement, popularly misnamed "automatic volume control" is intended to maintain the strength of the signal arriving at the detector nearly constant, thus compensating for different signal strengths of different stations and for fading. It does this by varying the sensitivity of the R.F. and I.F. amplifiers and consequently the proper name should be "automatic sensitivity control." The volume of course is not kept constant because this depends on the percentage of modulation at the transmitter. This is being varied in accordance with the volume of the transmitted sound and music. To try keeping this constant would be ruining the effect of music; consequently it would not be

desirable to make a true "automatic volume control." In the following discussion, however, the popular terms automatic volume control and A.V.C. will be retained.

Refer now to Fig. 1, at left. In this illustration is shown, A, an A.V.C. system often used in up-to-date sets, and is perhaps the easiest to explain. Forgetting for a moment the grid-return resistors in the R.F. circuits, let us begin with the detector.

THE "A.V.C. DETECTOR"

The signal is rectified by a diode. Current can flow only when the diode becomes positive and the coil must then be considered as the generator. This will perhaps help to explain why the resistor R1 will carry a current in the direction of the arrow, making the point P negative with respect to the cathode and the chassis. For many this point seems to be difficult to understand.

The current flowing between P and
(Continued on page 747)

Amplifiers and reproducers can easily be overloaded—but few people know that the human ear can also be overloaded; and when it is, the brain hears sounds that have not reached the ear! Read how hearing differs.

N. H. LESSEM

HOW DO WE HEAR?

PART II

THIS DISCUSSION on how we hear and why we do not all hear alike brings to mind the odd case of a very able Service Man, a friend of the writer, whose ears, unknowingly to him, responded only to the middle portion of the audio frequency spectrum. One day he was sent to service a radio receiver, the complaint on which was: "annoying whistle." When he arrived and turned on the set he could find nothing wrong with it. Calling the lady of the household, he asked, "What seems to be wrong with the set, it plays OK?"

"Why, that wheezing whistle," replied the lady, "it wasn't there when we first bought the set and it's very annoying."

"But I don't hear anything now, lady, maybe it's cured itself." But the lady was steadfast.

Had this Service Man been a less broadminded fellow he might have considered the lady "nertz" and said that nothing could be done about it. Instead he called his office and asked that another man be sent over immediately. Much to his surprise, however, this second man corroborated the lady's story. The whistle was a high-pitched "wheeze" in the neighborhood of 4,500 cycles, but his ears could not respond to that high frequency.

Similarly, he was not able to distinguish by ear the presence of a hum frequency reported by the same customer. However, in this instance he was able to detect the sound by *bone conduction*, by holding one end of a screwdriver in his teeth and touching the other to the loudspeaker.

Now this Service Man couldn't possibly enjoy the same degree of appreciation of a fine philharmonic band as experienced by a person whose ears responded to frequencies ranging up to 16,000 or 18,000 cycles and down to less than 100 cycles. Instead, he would lose practically all the high notes of the violin and other high-pitched instruments; and the low (fundamental) notes of the kettle drums and other low-pitched instruments.

Why is it, then, that not all of us interpret identical sounds similarly? Why is it that the note "A" on the piano, for instance, may be "heard" as differently-sounding "piano tones" by two persons side-by-side?

THE EAR MECHANISM

Part of the explanation has been given to you in Part I, but to get a clearer picture of how the entire ear mechanism looks let us travel with the sound waves as they progress from the outer air throughout the entire structure of the ear. Neglecting the *pinna*, which is merely a collector, the sound waves in the air (which are nothing but in-

WRITE A LETTER—WIN \$5.00!

RADIO-CRAFT will pay \$5.00 to the person who sends in the best letter containing suggestions for increasing the interest and value of *RADIO-CRAFT* to the largest number of its readers. Even a single good suggestion may win this award.

Rule: Use only one sheet of paper and write on only one side. Contest letters to be eligible must be received at RADIO-CRAFT office, 99 Hudson St., N. Y. C., by midnight, May 31, 1936. In the event that ideas are duplicated, the one carrying the earliest postmark will receive the award. Anyone (excepting employees and their relatives, of Continental Publications, Inc.) is eligible to enter this contest—there are no "strings" attached.

a varying pressure of the air molecules) in impinging upon the eardrum force this diaphragm to vibrate. In its inward motion it presses against the hammer of the 3 bones in the middle-ear, the hammer in turn presses against the anvil, and the anvil against the stirrup, which finally makes contact with the tiny diaphragm in the oval window. On the other side of this diaphragm is the liquid of the inner ear. Now, since liquid has a considerably greater density than air, it is necessary for the oval membrane to vibrate with considerably greater force than the eardrum in order to transmit the sound waves to the liquid. This action does actually take place and is a function of the 3 bones in the middle ear.

While the *amplitude* of the waves is thus *decreased*, their *pressure* is *increased*. The *amplitude* of the sound waves hitting the ear drum is *reduced about 30 to 60 times*. At the same time, through the medium of the lever arrangement of these bones, the *pressure* against the diaphragm of the oval ear (which as explained before is hardly larger than a pin head) is *increased in the same proportion*. The pressure against this oval diaphragm at a particular instant causes the liquid in the inner-ear to be pushed in, but in-

asmuch as liquid is practically incompressible it must find an outlet somewhere in the inner-ear or else it could not be pushed inward.

This outlet or "escape" is provided by the flexible diaphragm stretched across the round window at the base of canal C. In order to reach this "escape" the liquid has to travel up canal AB, through the *helicotrema*, and down canal C to the flexible diaphragm, or—it may depress the *Basilar membrane* anywhere along its length (depending upon the frequency of the sound impressed upon the liquid) thereby causing the liquid in canal C to find its "escape" through the elastic diaphragm at the round window.

LIMITATIONS OF HEARING

A note of about 20 cycles or less vibrates at such a low frequency that *the entire liquid is moved in a mass*, bodily, up canal AB, through the *helicotrema* and down canal C, *without causing the membrane to vibrate*. Hence, while actually a vibration of 20 cycles per second does exist in the liquid it is not "detected" by the hearing mechanism and, so far as the individual is concerned, it therefore does not exist.

On the other hand, when a high-frequency note (in the order of 18,000 to 20,000 cycles per second) is fed into the system, the relatively large mass of the 3 bones in the middle-ear cannot follow the rapid vibrations quickly enough, and hence they are not transmitted to the inner-ear at all, or at least not in an intelligible manner. (They may cause a sensation of pain or some other peculiar sensation, but not intelligible sound impressions.)

We learn therefore the manner in which we distinguish between extremes
(Continued on page 749)

Fig. 1. This illustration is repeated here to avoid the necessity of referring to Part I for the reference figure.

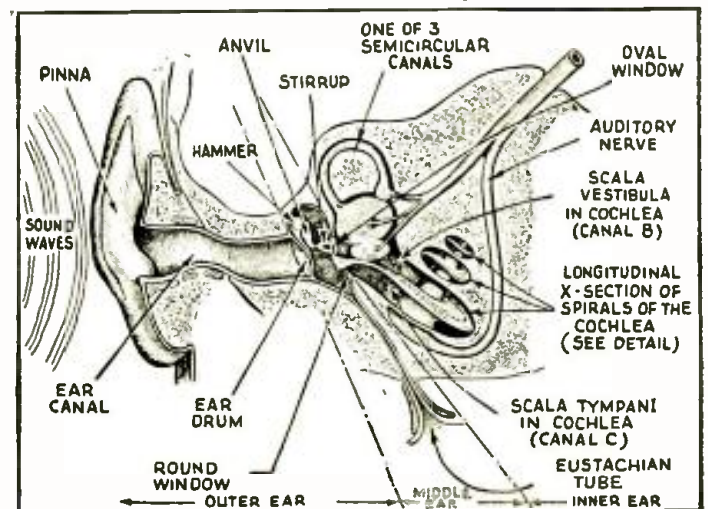

INTERNATIONAL RADIO REVIEW

RADIO-CRAFT receives hundreds of magazines from all parts of the world. Since the cost of subscribing to each of these would be prohibitive for most radio men, we have arranged with technical translators to prepare reviews for our readers.

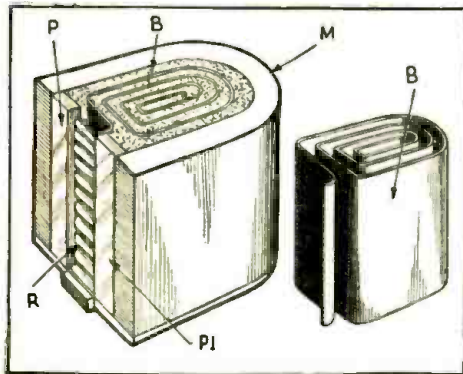

Fig. 1. A ribbon mike of the lapel type.

A RIBBON LAPEL MIKE

ACCORDING to a recently-issued English patent — No. 438,090 — a new type of velocity mike having unusual features and small enough to be suspended from the lapel of a coat has just been perfected.

As shown in Fig. 1, this consists of a powerful horseshoe magnet, M, 2 pole-pieces, P, P1, a ribbon diaphragm, R, and a "sound absorbing labyrinth", B, packed with felt or other damping material. The last-mentioned item forms a "mechanical impedance load" for the diaphragm, prevents back-wave absorption and permits the entire mike to be made small enough for use as a lapel-type unit.

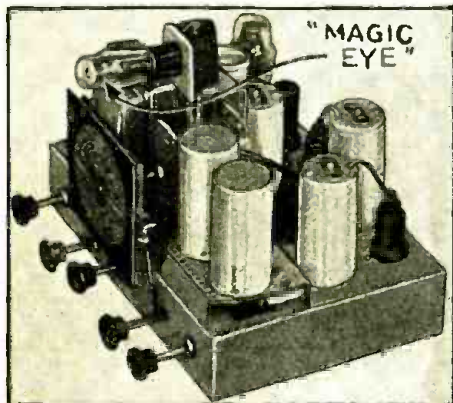

Fig. A. Metal tubes have "taken hold" in Australia.

METAL TUBES IN AUSTRALIA

IN A recent issue of the *Radio Review of Australia* (Sydney) two new receivers made by the largest manufacturers of sets in Australia, were shown. These sets, one of which is shown in Fig. A, use metal tubes (throughout except for the 6E5 cathode-ray tuning indicator which is found in the model shown).

The unusual fact of this acceptance of the metal tubes is not at once apparent. Some 2 or 3 years ago, English tube manufacturers introduced "metal" tubes called "Catkins" which used an expensive metal-glass seal. These tubes, for one reason or another, were not satisfactory, and ever since then radio fans in England and Australia have been biased against metal tubes in general.

Thus, the acceptance by Australian manufacturers of the American metal tubes is a healthy sign of their success and wide usage.

(Continued on page 748)

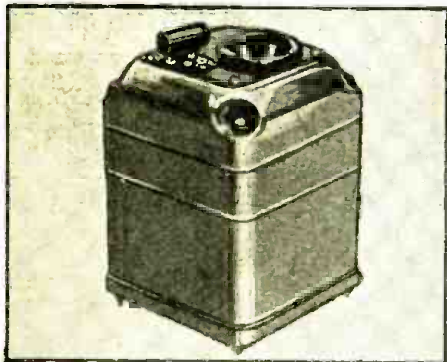

Fig. B. Power transformer and tube socket.

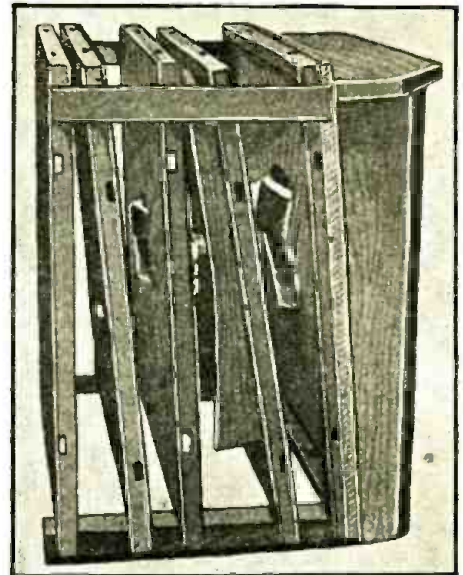

Fig. C. The reflectors distribute sound waves.

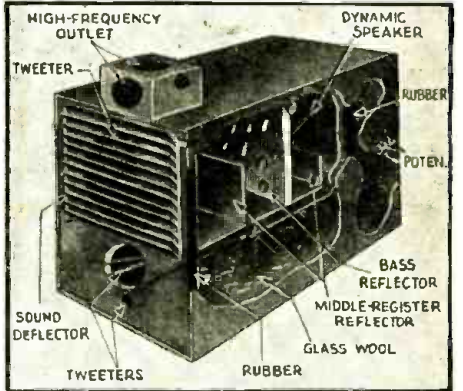

Fig. D. A complex baffle of German origin.



Fig. 3, right. Exponential speaker cone.

Figs. E and F, lower right. The Marconiphone 2-band auto-radio receiver; and how it is installed.

Fig. 2, below. The two circuits of the "A.S.C." system for high-fidelity receivers.

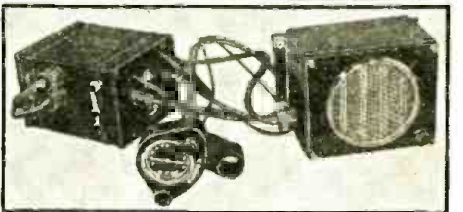
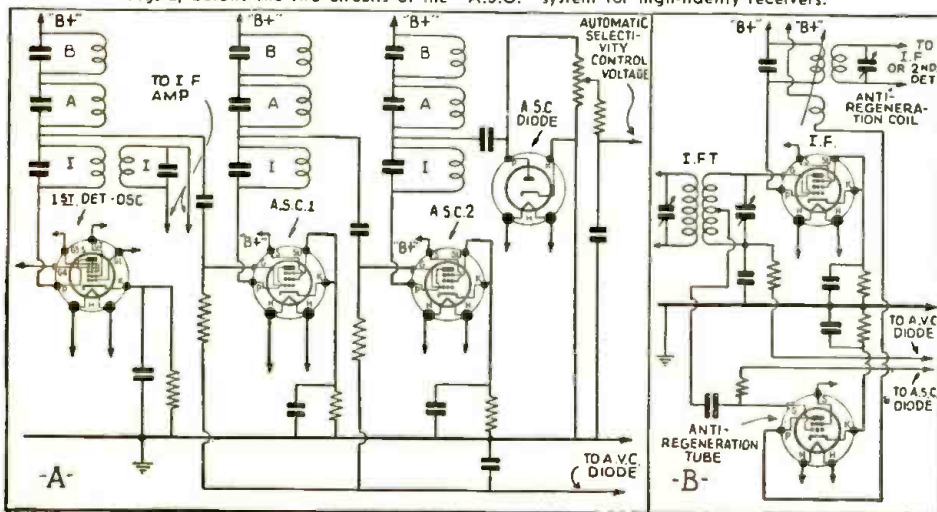

NEW DEVICES FOR THE CAR-RADIO OWNER

Accessories that the car-radio owner will find novel or useful are here described.

CAR-TOP ANTENNA

(1043) This antenna system is designed for use on all cars, but particularly on those with the new turret tops. No drilling is necessary for installation, and the car is not marred in any way. The antenna can be removed at any time, since it is fastened in place with rubber suction cups, which when applied according to directions will hold firmly and indefinitely. Rain or ice will not affect the operation of the antenna; and the capacity between antenna and car top is unusually low. Tests apparently show that this antenna is more efficient than any type tried under similar conditions.

One end of the antenna has a special connection for fastening it to the shielded lead-in, the connection being made in such a way that the contact will not corrode or cause noise. The design is such that there is no vibration in the system under any conditions. The antenna proper is made of 3/8-in. pure copper tubing, which may be had finished in either cadmium or polished-chromium plating. A sufficient length of tubing is furnished with each kit to run the full length of any car, and the kit also contains all other necessary materials such as special vacuum cups, insulators, connectors, and shielded lead-in wire.

CAR-BATTERY RATE-OF-CHARGE BOOSTER

(1044) Modern car-radio receivers are being designed with more and more tubes, and as they increase in size, the current drain goes up accordingly. Some of the latest sets take as much as 10 A. or more, a drain which puts a serious load on the car battery. This is especially true of cars in which small portable P.A. systems are operated, such systems often drawing 15 A. or so in spite of their small size and portable characteristics. When a car also has the lights turned on, the drain becomes seriously large. The unit here

illustrated is designed to increase the generator charging rate by an amount equal to that taken by the radio set. It can also be used to compensate for the current drain of any other electrical equipment on the car to which it is attached.

The adjustment is very simple and is made by means of the slotted screw C on top of the case. The lead from B is connected to the pilot lamp, the speaker field, or any other point in the car-radio circuit which is at 6 V. potential when the radio set is turned on. Turn the screw, C, to the extreme clockwise position; this cuts resistance D out of the circuit. Start the engine and turn all switches off except the ignition switch. Then set the generator 3rd brush to the position which will give the maximum charging rate desired. Then move C to the position which gives minimum charging rate. If, for example, the lights consume 8 A. and the car-radio receiver takes 6 A., set the brush so that the dash ammeter shows the total (14 A.). Then move screw C until the ammeter shows 8 A. Now, the instant the radio set is turned on, contacts E will close and the generator charging rate will be increased to 14 A., which will raise the charging rate enough so that the extra drain of the radio set will not run the battery down. When the "radio" is turned off, points E will open and the charging rate will drop to 8 A.

The Service Man should take special note of the fact that the same device may be used for any other apparatus besides the car radio receiver, so that its application is quite universal.

The operating magnetic coil only consumes a few milliamperes from the car battery; this extra drain is not noticeable. There is nothing to get out of order and the unit will work perfectly for long periods of time with no attention whatsoever. By its use the lights of the car can be protected from burnout due to excessive charging rate.

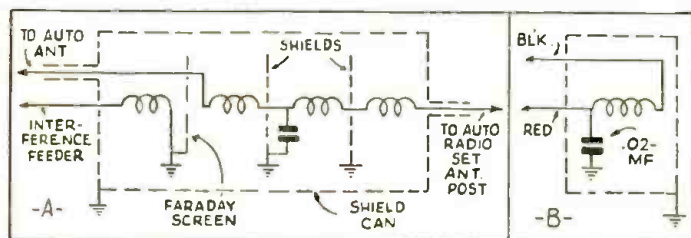

Above, the "interferotrol." (1045). Below, a new "converter." (1046)

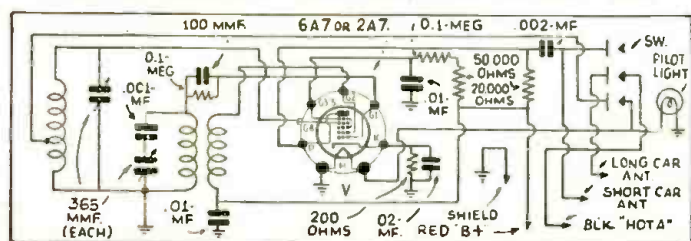

Above and below. New top-of-car antenna improves radio reception. (1043)

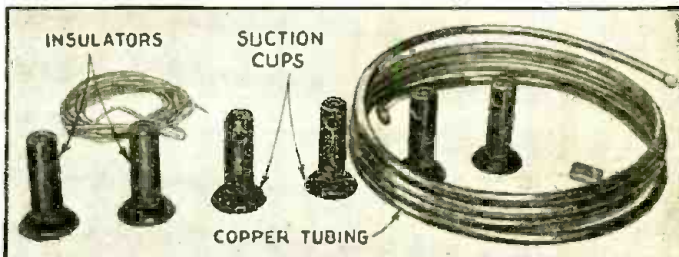

IGNITION ELIMINATOR (Insuline Corp. of America)

(1045) Many arguments have been started regarding what effect the use of ignition noise suppressors will have on the operation of a motor. By use of the device illustrated at A, these arguments may be stilled forever, for if properly used it removes the ignition noise completely, states the manufacturer, and no changes whatsoever need be made in the original ignition system of the car.

The filter is placed as close to the set as possible, and a shielded connection made to the antenna lead from the set. The other shielded lead is connected to the regular car antenna. The rubber-covered wire is clamped to any part of the car (to be determined by experiment) which will feed into the system an amount of ignition noise approximately equal to that coming in over the regular car aerial.

The balancing coil is then moved in or out with the set-screw at the end of the can, until the noise is eliminated from the radio set output. The efficiency of the car set is not impaired in any way, and the adjustment holds for all frequencies, and for all conditions of the ignition system.

In order to obtain the best results from the balancing arrangement just described, it is very important that there be no noise entering the set through the battery leads. The line filter at B may be connected in the "hot A" lead and will remove all such noise before it reaches the circuits of the receiver, so that the balancing system may work to full efficiency. The filter may also be used in other lines which enter the receiver case, such as the pilot lamp lead. There should be no noise in the set with the volume control full-on, and with the antenna disconnected.

S.-W. CONVERTER (ABC Radio Laboratories)

(1046) The small unit illustrated measures only 3 x 3 1/2 x 9 ins. deep. This particular model is designed to cover the police band from 1,500 kc. to 5,500 kc. It will receive amateurs, aviation stations, police and many other services in this band. It is designed principally for installation in official and government cars for police calls. Another model, which is the same in size, is made for use on the 19- and

(Continued on page 746)

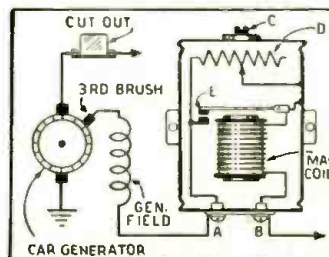

Above and below. Here is an exceedingly novel "robot" that directs an increased changing current to the car battery to compensate "A" drain by the radio set. (1044)

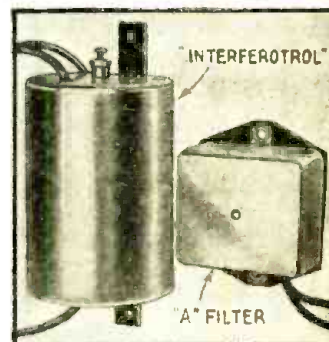

Above, the "interferotrol" (diagram at upper-left), (1045) Below, this converter is diagrammed at lower-left. (1046)

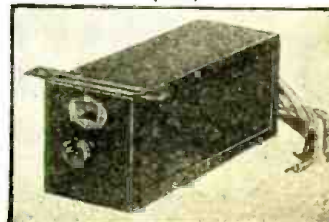

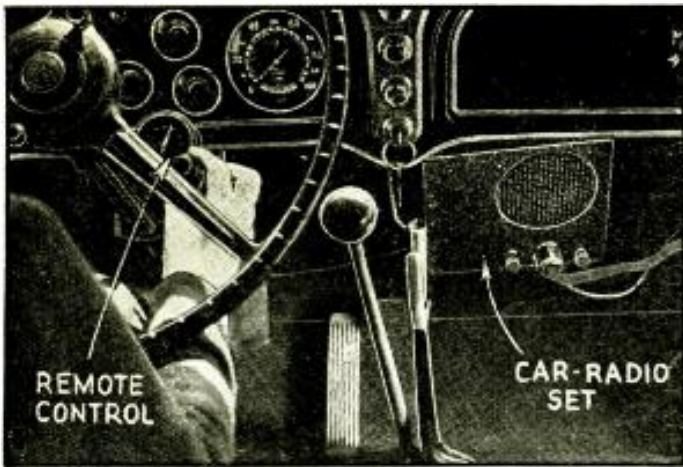

HOW TO MAKE THE RADIO-CRAFT CAR-RADIO SET

There is a real field for the progressive custom set builder in making and selling superior auto-radio receivers. This one was made after months of laboratory work.

HERE'S a car superheterodyne featuring some of the more outstanding radio developments of the past year—including the metal tubes, universal control, new type sockets, and iron-core inductances for high R.F. and I.F. gain. It becomes the final expression of two months of laboratory study—on available standard parts, on commercial auto-radio design practice, on the peculiar needs of the custom builder. Properly constructed with the parts specified, properly aligned and installed—similar sets should provide an overall performance, in terms of selectivity, sensitivity, tone, and automatic gain control, equalling if not bettering that of any commercial or built-up car job engineered for ordinary service. It has greater inherent signal pick-up power and far greater I.F. gain than the average set, and it has been designed for easy construction with a minimum of effort. Very little mechanical work is involved—except in the drilling of the cabinet (a standard part) and the bending and drilling of the chassis.

This receiver is a two-piece job—one departure from conventional single-unit practice. The speaker is contained within the cabinet proper, with the vibrator "B" supply separate, to keep the size and weight of the actual set as small as possible and to permit experimental adjustments and powering changes. It is, briefly, a 6-tube superheterodyne, commercial in appearance, of simple and effective design, adequate

power output, and excellent tonal quality.

THE CIRCUIT

Refer to the schematic for details. A single 6K7 R.F. stage feeds the 6A8 converter, and a single 6K7 I.F. stage amplifies the converted signal at 465 kc. A high-gain diode feeder transformer is used with a type 6H6 second-detector, arranged with plates and cathodes in parallel. The 6H6 detector circuit feeds from an A.V.C. voltage to the R.F., converter, and I.F. stages, a switch being used to shut off A.V.C. when not desired. The rectified modulation is amplified by a 6F5 triode and power amplified by a 6F6 pentode.

In the circuit published, note that the R.F., detector, and first audio tubes are wired for operation at full 250 V., while the pentode power amplifier receives only 180 V. The reason for this is as follows: A 6-tube set with a pentode amplifier and working under "full efficiency" conditions will draw more current than any normal vibrator or generator power supply safely delivers. It will draw up to 70 ma. This receiver depends upon full and efficient operation of its R.F. and I.F. stages for its unusual properties of high gain and high order of selectivity and sensitivity. Therefore, we give the tubes in these stages all the high voltage we can get—about 250 V. at 30 ma. This leaves about 20 ma. of extra current—which we assimilate in the 6F6 pentode nicely by reducing its plate supply to 180 at which

voltage it requires about 18 ma. The 6F6 does not, of course, give full 3-W. output at these ratings—but 1.5-W. will be found entirely satisfactory for mobile service, especially in this receiver, in which the R.F. gain is such that signals are brought well above noise level.

It should be noted that decoupling resistors are used in the converter and I.F. plate circuits. These are necessary due to the high orders of gain made possible by the iron-core inductances. The lower the resistance of a coil, the greater its tendency to oscillate with ease. Stray coupling between leads, common coupling, and other factors also tend to introduce instability in high-gain circuits. And as we want complete stability—the decouplers are definitely necessary.

Plenty of bypass condensers are used in the set. These are further insurance against oscillation.

A variable control acts as a fixed 500,000-ohm load for the 6H6 diode—with the variable tap feeding the succeeding voltage amplifier through a 0.05-mf. coupling condenser. Movement of the variable contact determines the volume setting.

A tone control in the plate circuit of the power pentode permits adjustment of the response to suit individual tastes. Decreasing its resistance cuts off the higher frequencies, accentuating the low—an effect, by the way, which materially aids in the elimination of static and noise.

Two substitute second-detector circuits are given. Either of these will permit the use of one of the newer metal second-detector—1st-audio amplifier combination tubes in place of the 6H6 with its separate associated 6F5 amplifier. The 6F5 socket then holds a type 6C5—providing increased amplification.

CONSTRUCTION

The original model, as we have said, was built into a 6 x 9 x 8 in. crackle finished cabinet, designed for use as a shield box. This box had an 8 x 9 in. removable cover—which became our front panel.

Similar cabinets should be drilled as per the illustrations given on page 750. Constructors making their own boxes should use the measurements given—relying upon their own judgment as to how the cabinet should be formed.

The rear of the receiver chassis showing the compact mounting of tubes, coils, etc.



Alternative second detector arrangements.

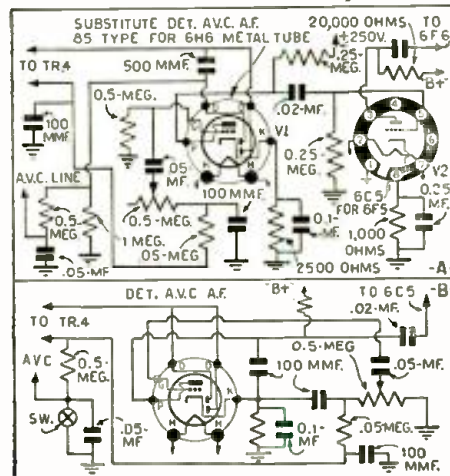

The easiest way to drill the speaker hole is to saw it out roughly and even up its edges with a file. The second best method is to drill or punch holes around the intended circumference—breaking through from hole to hole with a cold chisel. If the holes are made close together, single hammer blows on the chisel, whose edge is placed between two respective holes, should be sufficient.

The rest of the work is easy. There are 9 smaller holes on the front panel, 3 on the back of the cabinet, 2 on the right side, 4 on the left side, and 2 on each side lip of the front panel. The front panel holes for A.V.C. switch and tone control should be of 1/2-in. width—to permit the installation of the units with insulating washers.

The chassis layout, shown on page 750 adequately explains size and drilling specifications. Note that tube socket holes are all 23/16 ins. in dia.—to fit the sockets.

MOUNTING PARTS

First, mount 3 long stove bolts in the holes provided in the cabinet back. Place 1 in. width washers under the heads and under the securing nuts. Mount the power plug receptacle socket, and the A.V.C. switch and tone control on the chassis, being sure to insulate the control shaft from the metal. Fasten the speaker in place on the front, with a black-painted wide-mesh screen between it and the panel. Mount the tube sockets and coils on the chassis. Mount the variable condenser, with rubber washers between it and the chassis. Secure the front panel to the chassis by means of the A.V.C. switch and tone control, adding a chassis-to-front panel angle as shown in the photographs, if extra support is necessary. Methods of mounting the antenna coil and the volume control and switch combination are several. The constructor should simply discover that one which in his mind permits the securing of these items in place safely and definitely. Remember to keep the shaft of the volume control free from any metal (ground).

(Note: In mounting tube sockets, place them in position to provide for short leads to associated apparatus.)

The oscillator pad should be of ap-

proximately 370 mf. fixed capacity—bridged by a mica trimmer.

TESTING THE SET

Wire the connector lead to the "B" unit and plug it in. Make sure all tubes are receiving proper voltages at the socket terminals. Adjust the I.F. transformers for 465 kc. on service oscillator, then line up the R.F. circuits for proper tracking, making sure to adjust both the main trimmers on the 3-gang variable condenser and the oscillator pad trimmer below the chassis.

If the tubes are receiving proper voltages and the circuit is properly aligned, with no bypass condensers open or shorted, and all R.F. leads short, direct, and properly placed in relation to each other, no I.F. oscillation should result. If such oscillation is experienced and nothing short of reduced screen or plate voltage stops it—try plate decoupling resistors of increased value. The 1,000 ohm decouplers specified should entirely do away with oscillation—and without seriously reducing voltages as applied at the plate terminals of I.F. sockets.

When the set is operating properly and signals are tuned in with ease, it is ready for installation.

LIST OF PARTS

- *One cabinet, 6 x 9 x 8 ins., (MSB-2);
- *One chassis to match, (MSC-2);
- *One dynamic speaker, 6-ohm field, transformer to match 6F6;
- One piece of large-mesh screening, black-painted, about 6 x 6 ins.;
- *Six 8-prong octal sockets;
- *One 5-prong socket, (RS-5), P;
- *One 5-prong cable connector; (PM-5);
- *One connector cover; (C-CHA);
- *Three washers, (203);
- *Three washers, (212);
- One I.C.A. flexible coupler for 1/4-in. shafts, (2101);
- One I.C.A. equalizing condenser, 20-100 mmf., (612), C4;
- One Eby S.P.S.T. switch, (14-B), SW;
- *One polyiron antenna coil, 530-1,500 kc., (1501), TR-1;
- *One polyiron R.F. coil, 530-1,500 kc., (3001), TR-2;
- *One polyiron oscillator coil to match, (2001), TR-5;

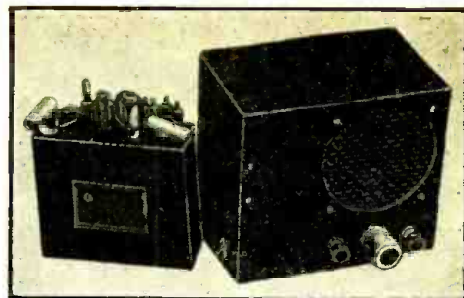

Above, the complete set with its power supply unit and noise suppressing equipment. Below, the under side of the set chassis.

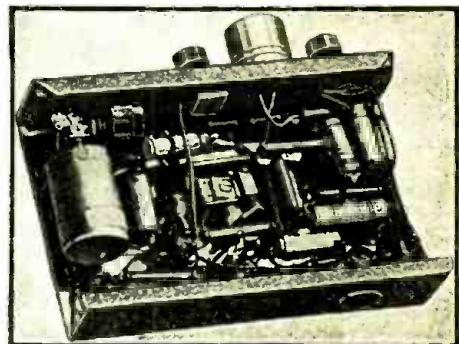

- *One polyiron I.F. coil, 465 kc., (C101M), TR-3;
- *One polyiron I.F. coil, 465 kc., (C200M), TR-4;
- *One 3-gang variable condenser, 370 mmf. each clockwise, trimmers left, (320-17), C1, C2, C3;
- One Aerovox mica condenser, .00037-mf., (1468), C4A;
- Two Aerovox mica condensers, .0001-mf., (1468), C13, C14;
- One Aerovox mica condenser, .000075-mf., (1468), C6;
- One Aerovox cartridge bypass condenser, .25-mf. 200 V., (284), C17;
- Four Aerovox bypass condensers, .1-mf. 400 V., (484), C11, C12, C21, C22;
- Three Aerovox bypass condensers, .1-mf. 200 V., (284), C8, C9, C19;
- Three Aerovox bypass condensers, .02-mf. 400 V. (484), C5, C18, C23;
- Four Aerovox bypass condensers, 0.5-mf., 400 V.; 200 V. (234), C7, C10, C15, C16;
- One Aerovox hi-farad condenser, 10 mf., 25 V., (PR-25), C20;

(Continued on page 750)

The circuit of the set shows the iron-core coils, metal tubes and other features. The compactness of the set can be seen in the photos.

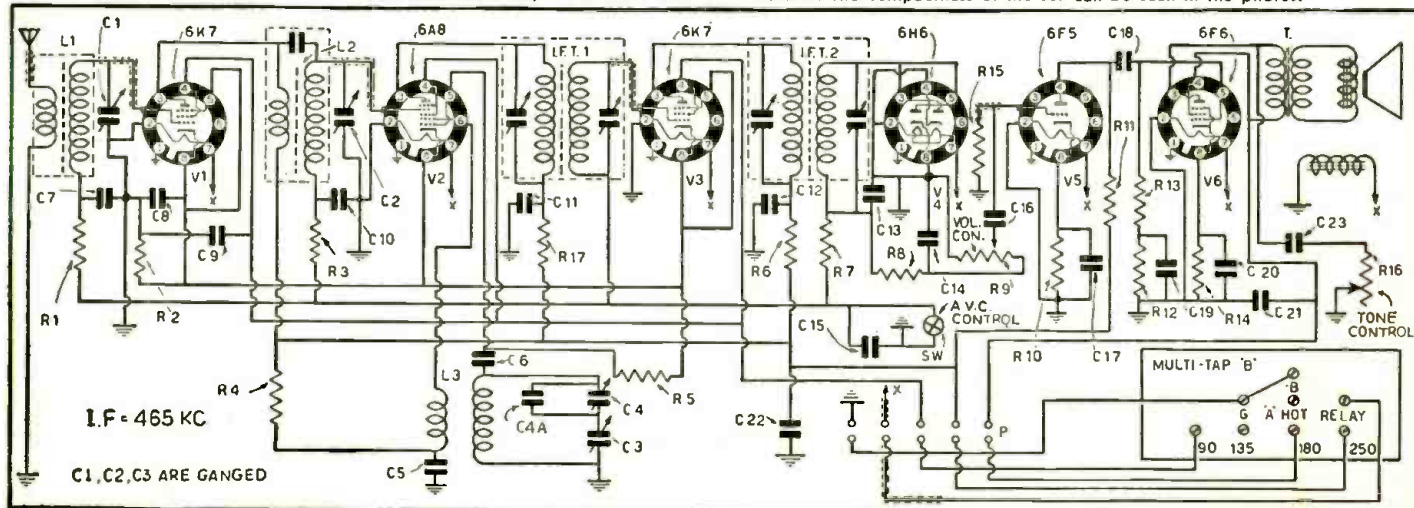

RECENT TUBE DEVELOPMENTS

An improved cathode-ray tuning indicator tube heads the list of this month's crop of new tubes. It has variable-mu characteristics. A metal power resistor is included.

C. W. PALMER

THE RADIO INDUSTRY through habit has come to expect a certain number of new or improved tubes each month, and no doubt would be greatly disappointed if these new vacuum bottles failed to make their appearance!

This month's crop consists of an improved cathode-ray tuning tube, a few new metal-glass tubes of types already available in the "regular" steel jackets, and a hybrid tube which is really a resistor but which has all the ear-marks of the latest metal vacuum tubes.

The 6G5. The cathode-ray tuning indicators now in vogue are interesting both in principle of operation and the results obtained. A general understanding of the principle of operation may be gained by thinking in terms of an analogy.

Omitting, for the moment, a consideration of the triode section, the cathode-ray unit may be viewed in the light of an optical analogy. In such an analogy the cathode becomes the source of light and the target becomes a screen

on which the light shines. Interposition of an opaque member between the source of light and the screen will produce a shadow, and changes in size of this opaque member will produce changes in the size of the shadow. In the cathode-ray tuning indicator we have an electronic set-up closely resembling this optical set-up.

The electrical action of the 6E5 cathode-ray tuning indicator was explained in detail in the December, 1935 issue of *Radio-Craft*, page 348.

The 6E5 incorporated a triode, the control-grid of which could handle up
(Continued on page 750)



Left. The appearance of the new metal-tube power resistors. Below. Connections for the 6G5 tuning indicator tube.

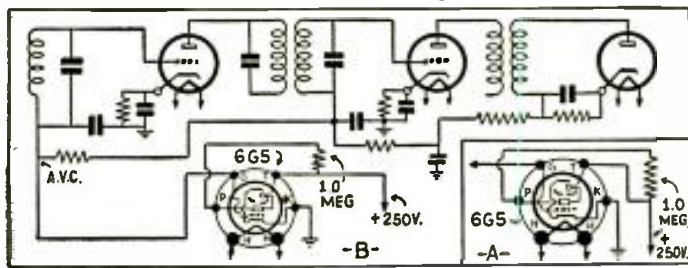

The shadow angle of the 6G5 tube.

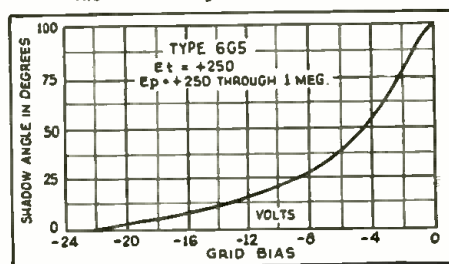

IMPORTANT FACTS ABOUT SCHOOL SOUND SYSTEMS

A continuation of the technical considerations covering P.A. installations in schools.

R. H. VON LIEDTKE

PART II

THE CIRCUIT must be sensitive to a greater degree than the human ear so that none of the sounds and their harmonics that are impressed upon the diaphragm of the microphone are lost.

For comparison, if you would place yourself in the conductor's position in front of a great symphony orchestra and listen with his trained ears to the enormous, intricate ripple of sound waves which are sent into the air by the numerous instruments, you would be

astounded and you would wonder how the immense detail of these sound waves could be picked up by the microphone and how it is possible for the amplifier to reproduce this immense amount of sound and its different characteristics in every detail. One of the main factors that make up our great symphony orchestras is perfect blending of the different instruments and, as you know, some of them are of a "soft" character and yet they can be heard through the

maze of instruments. The amplifier must be able to reproduce these soft-sounding instruments and their definite characters with the same amount of timbre or tonal force, and with the same sharpness and distinctiveness as they are heard by the conductor—and still blend all the instruments perfectly. The great trouble with the average amplifier of today is that its limited sensitivity will not permit it to pick up the soft-strain instruments and thus all the listener really hears are the predominating instruments.

A typical school set-up for the distribution of sound. (Wright-Deeoster Illus.)

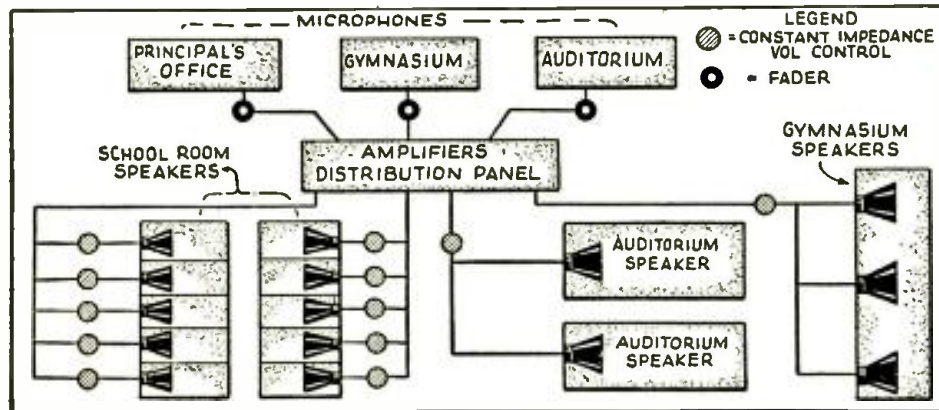

Another controlling factor of the sensitivity is peak frequencies which are introduced in the transformers. When the gain in the amplifier is increased, these peak frequencies arrive at the rated output of the amplifier much faster than the balance of the frequencies to be amplified. This means that distortion is being introduced long before all the other sound waves can be brought to the rated output of the amplifier.

CLASS A AMPLIFICATION

What is class A amplification? Class
(Continued on page 752)

THE "ANTI-HOWL" AUDIO AMPLIFIER

A NEW DEVELOPMENT IN SOUND EQUIPMENT

Some radically new ideas in P.A. equipment and procedure will be found in this informative article. Don't miss it!

A. C. SHANEY PART I

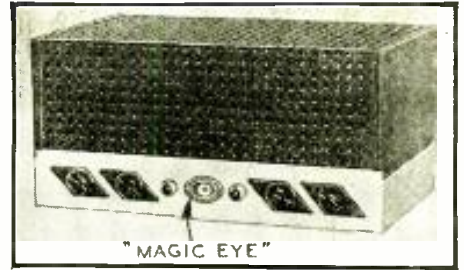

EVERY MAN interested in sound systems of any kind will be interested in this highly informative discussion which discloses for the first time the needs, principles, and applications behind the following (Table I) revolutionary audio amplifier design features.

TABLE I

1. Automatic Howl Suppression.
2. Automatic Constant Output.
3. Automatic Gain Control.
4. External Noise Suppression Control.
5. Tandem Class A and Class B Audio Amplification.
6. Volume Range Expander.
7. Cathode-Ray Control Indicator.

Suppose that 10 years ago you had purchased the most modern amplifier available and used it for some P.A. application. If you were to check this same amplifier (then considered to be the ultimate in design) against the more advanced 1935 models you would find literally hundreds of improvements that were lacking in this earlier model. In fact, one could hardly believe that the antiquated device was tolerated by human beings.

Of course, few P.A. men are using amplifiers that are a decade old, but the comparisons are almost as startling if we compare a 2-year-old amplifier (or even last year's model) with some of the advanced 1936 amplifiers.

Before any comparison is made let us look at, and listen to the finest amplifier we know of, with the eye of a research man—who doesn't want to know

how good a thing is, but how bad it is, so that defects can be detected, eliminated, and a better product made.

John Doe, P.A. Rental Specialist (states the sign over his door), buys the finest 50-W. high-fidelity, high-gain, etc., etc., power amplifier he knows of; together with 4 high-fidelity, etc., dynamic speakers and 2 high-quality, etc., etc., microphones, with many minor accessories to complete his new system.

AUDIO HOWL FROM LOUDSPEAKER—AND CUSTOMER!

The outfit is correctly and temporarily set up in a large convention hall. The volume is turned up and a beautiful 800-cycle, 50-W. howl is heard! Speakers and microphone are shifted in a futile attempt to eliminate all feedback. Finally the volume control is reset to just below the point of howl and then the startling discovery is made that only 20 W. of audio power is available up to the point of feedback!

After the convention hall is filled, John Doe finds that he can turn his volume control up to a 25-W. output without feedback but discovers to his utter amazement that a round of applause sets his system into a familiar howl again. Once more the control is turned down to eliminate the interference.

The next orator does not like the idea

of constantly burying his face into the microphone so he moves from side to side and John Doe notices large volume fluctuations accompanying the movements of the orator. Finally, an announcement is made 10 ft. from the microphones, and as expected, nothing comes through the loudspeakers. John knows that if the control is turned up the system will howl so he looks at his fine amplifier system

with the eye of a research man and on the basis of his observations and experience with his P.A. system records the list of defects in Table II.

TABLE II

1. Maximum power output can rarely be attained (from microphone pick-up) without howl.
2. Maximum gain (remote pick-up from microphone) can rarely be attained without howl.
3. Large output volume variations noticed when orators move towards or away from microphone.
4. When the P.A. system is adjusted for best results (for volume and "mike" pick-up) loud applause or any unusually loud sounds cause feedback.
5. At very low output levels the quality of reproduction seems poor.
6. At very high output levels distortion is present.
7. External noises (other than the

(Continued on page 751)

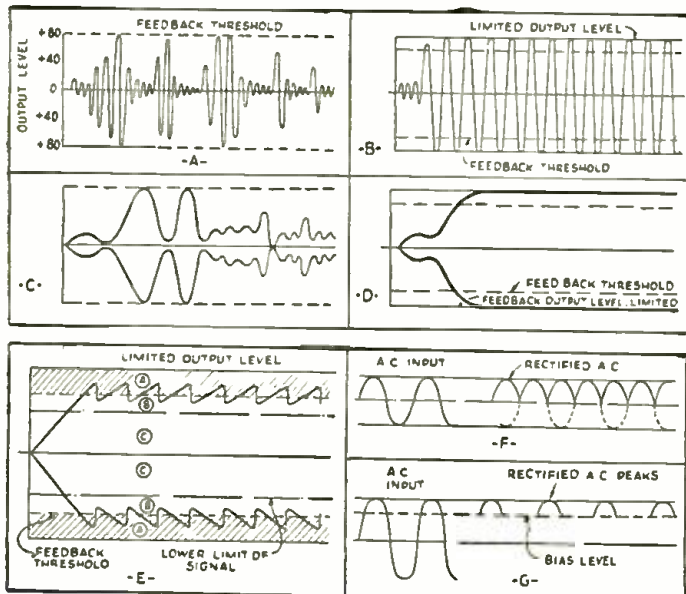

Fig. 1, left. A—Normal voice frequencies with peak levels below the feedback threshold. B—Voice frequencies exceeding the feedback threshold and causing sustained feedback. C—The envelope of the voice frequency pattern of detail A. D—Envelope of voice frequency pattern bursting into audio howl. E—Envelope of signal fed into the howl suppressor. Note the effect of the suppressor which rectifies the peaks and continually pushes the signal level back to the safe pick-up region. (A) Feedback region. (B) Range of howl suppression. (C) Areas including (B) of useful operation. F—This curve shows the normal action of a full wave rectifier. The section of the wave below the zero line is transposed above the line by the rectifier. G—This is the action of a biased rectifier

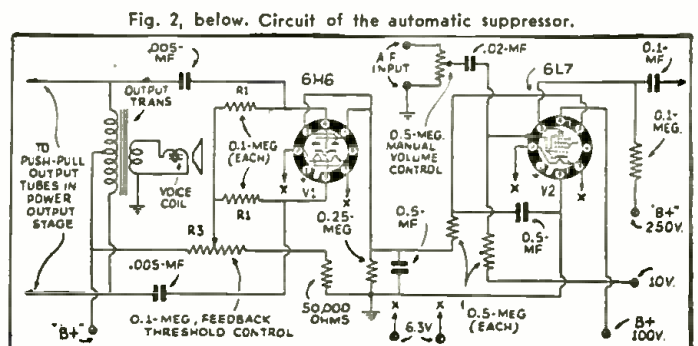

Fig. 2, below. Circuit of the automatic suppressor.

ANALYSES of RADIO RECEIVER SYMPTOMS OPERATING NOTES

Radiola, Models 80 and 82. The presence of plate voltage on the detector tube of the above receivers does not necessarily indicate a good input transformer! Voltage will be present even if the transformer is completely open. The reason for this is shown in Fig. 1, and knowledge of this fact will save the Service Man a lot of worry and unnecessary testing when working on this particular receiver.

Westinghouse WR5. Ditto.

General Electric H31. Ditto.
* W. L. PATRICK

Atwater Kent 99. This set came in marked "dead." Extensive testing led us to suspect the I.F. transformers and upon removing the cans we found a resistor inside which was shorting against the side of the can. This was shoved over and thoroughly insulated and normal operation was restored. The condition is shown in Fig. 2, and a symptom of this trouble will be found upon examination of the neon lamp, which does not light when this particular resistor is shorted.

Brunswick 15/22. This set had a rushing sound like escaping steam, which seemed strongest on the lower

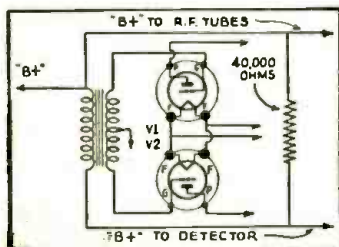

Fig. 1. Defective input transformer.

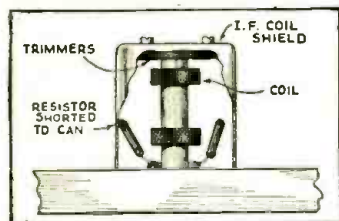

Fig. 2. "Dead" Atwater Kent 99.

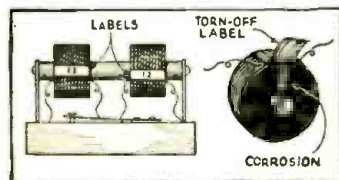

Fig. 3, above. Corroded I.F. coil.

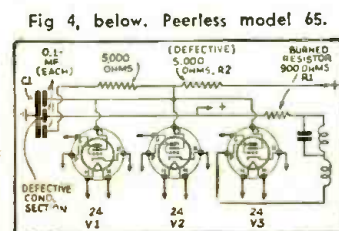

Fig 4, below. Peerless model 65.

end of the dial. While testing condensers, we removed the one across the local-distance switch and the set, which had been left turned on, started playing at full power. Other condensers were tried in this position, but the operation was much better without any so it was left out! The receiver has been working this way for some time now and is highly satisfactory to the owner.

Sparton 79. This receiver would burst into full volume when it had been playing at a low level. A new volume control failed to cure the trouble, and when the unit was removed, the set continued to play at full volume. This indicated that the cathode bypass condenser was at fault, and a test showed this unit to be leaking, allowing enough current to pass when the volume control was at minimum or disconnected.

ROY DAVIS

Westinghouse Models WR 5 to 8; and WR6R and WR7R (remote control). We have had several of these sets come in with the complaint of severe crackling noise. After lengthy testing of components without finding any poor ones, a milliammeter was inserted in the plate lead of each tube. The current in the circuit of the I.F. tube showed violent changes during this test. This was surprising, since the transformer had tested "perfect" on the ohmmeter. Nevertheless it was removed and examination showed the wire to be very badly corroded under the small labels which are glued over each coil (see Fig. 3). The glue used had either collected moisture or reacted chemically to produce a partial short of the turns. Replacement was the only cure.

General Electric Models H31, H51, H71, and 700. Ditto.

Graybar Models 700, 770, and 900. Ditto.

Peerless 65. This set came in with the complaint of "smoke coming from the chassis." Investigation showed that resistor R1 in Fig. 4 was badly charred. Condenser C1 was also found to be shorted. Replacement of these units produced faint signals with the volume control on full. Further checking showed that R2 having lost its resistance, a lack of screen-grid voltage on the 24s had resulted. A new 5,000-ohm unit cured this trouble and the receiver again worked to perfection.

THEODORE GOLEMBESKI

Westinghouse WR4. The volume control of these sets usually becomes noisy after some use, the trouble being caused by the bunching up of the wire. Replacement is not a permanent cure, and replacement with one of the new carbon strip type dual units is rather expensive. Rewiring to use a single unit type potentiometer is entirely satisfactory and very inexpensive.

The regular circuit is shown in Fig. 5A, while the revised arrangement is in Fig. 5B. The 25,000-ohm carbon unit is in series with a 300-ohm limiting resistor, which prevents the bias from becoming too low. The yellow with red tracer wire

should be unsoldered from the vitrified resistor (located about 6 ins. under the 45s) and then soldered to one side of R1. The ends of the red with green tracer wire and green with red tracer wires should be connected.

BURR JAMISON

Plymouth-Car Radio Sets. When a receiver in these cars shows a stubborn case of ignition interference, which all other methods have failed to cure, try removing the top of the distributor, and note if the brush is stuck. If so, a drop of thin oil will loosen it and the interference probably will disappear.

C. M. RUSSELL

Philco Transitone Model 3. If this set is "dead," and all voltage tests at sockets appear normal, look for water in the compensating condensers. This usually occurs after a heavy rain or a washing. The only remedy is to remove the mica and completely dry it.

Another common complaint in this set is the jarring loose of the field connections in the speaker. The result is little or no reception. To test for this condition, carefully stick a piece of steel (magnetic) wire through the screen cover of the reproducer with the set turned on and touch the wire to the centering screw of the cone. If the wire does not stick, the field circuit is open.

STANLEY L. STEVENS

Atwater Kent Model 465 Q. Service Men in rural districts and other places where air cell sets are used will find these hints of value. If one of the above sets works for 15 mins. and then fades slowly out, disconnect the red positive wire from the air cell and short out the resistor. This will enable the cell to be used for several weeks more. Of course, the resistor should be left in the circuit as long as the set works satisfactorily.

If the customer complains of poor tone, check the speaker coil, which has 3 leads, and you will generally find one side open. On the early models (with black enamel unit) the coil can be replaced, while on later models (with nickel unit) the whole unit must be replaced.

If the sets develop a sound like a fog horn when the set is playing at low volume, but work well when the volume is high, replace the black electrolytic condenser.

Atwater Kent Model 665Q. Ditto.
OSCAR J. LAMB

Incorrect pilot lights in battery-type receivers. In my service work on battery receivers, I have encountered many uncommon troubles, but the most outstanding and least noticeable concerns pilot lamps. When the pilot lamp of a 2 V. receiver burns out, the unsuspecting owner often replaces it with either a 2.5 V. flashlight lamp or a 2.5 V. A.C. pilot lamp, both of which have a much higher drain than the regular (low drain) 2 V. pilot lamps. This naturally runs the battery down very rapidly. I always take out such lamps and explain the difference to the owner and I am getting them trained, in this locality, to use the correct lamps.

W. A. FARNSWORTH

RCA Victor Model 121. In the past 4 months I have installed over a dozen 4 mf. filter condensers in these sets. In each case the customer complains that "the set is less than a year old." The only thing that protects the rectifier tube, when this condenser shorts, is a 30,000-ohm resistor. I sometimes have trouble, after a new condenser is installed, with instability. This was found to be caused by the long lead on the new condenser coming too near the wires on the wave-change switch.

FRANKLIN J. HOLMES

Echophone S3 and S4. Service Men who have worked on these sets have probably had the complaint of "very low volume," and "loss of signal when the volume control was turned on full." This condition is usually caused by an open 1-meg. resistor connected from "B+" to the S-G. of the 3rd type 24 tube (the detector). To test this unit I simply shunt it with my fingers, and if defective, an increase in volume will be noticed. This resistor is located on the panel which is mounted under the chassis at the rear. As it takes considerable time to replace the unit if the panel is removed, I simply pry it loose with a screwdriver, and replace with a pigtail-lead type.

An increase of about 40 per cent in volume may be had with the model S3 if the R.F. coils are replaced with those of the litz type used on the later S4 models. Rebalancing is necessary, of course.

L. P. HUNTER, JR.

Silver-Marshall Bearcat Model. The volume control on this set wouldn't cut the volume below room level. The control was OK but a

(Continued on page 155)

Fig. 5. A simple money-saving replacement made in the Westinghouse model WR4.

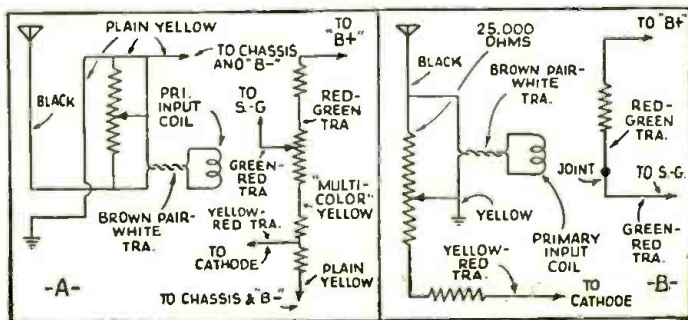

A SIMPLIFIED DECADE RESISTANCE BOX

Service Men will find this easily-made instrument extremely useful for set repairing.

G. F. BENKELMAN



DECADE RESISTANCE boxes are an essential part of the equipment in any school or industrial laboratory. They are used extensively in all types of Wheatstone bridge measurements and as a temporary substitute for special values of resistance in experimental electrical circuits.

That resistance boxes have not come into general use among radio experimenters and Service Men can only be attributed to the high cost of 10 precision resistors for each decade of the box. The writer believes that by designing a decade resistance box along more economical lines it will be assembled by home constructors using semi-precision insulated carbon resistors and double-deck rotary switches.

THE LEAST EXPENSIVE CIRCUIT

A design of this type has been worked out, using a minimum number of re-

sistors in a circuit which may be extended from one decade to several—which is easy to build and easy to repair in the event of one resistor or one section being damaged by excessive current.

The accompanying circuit diagram and parts list suggests the method of construction which may be employed. In assembling this decade box all of the wiring of each double-deck rotary switch should be installed first and the resistors attached last. The circuit is such that the resistors mount in line with the shaft of the rotary switch, and always between terminals in line with each other. This permits short leads on the resistors and very compact assembly.

Due to the parts being very close together it is highly advisable to employ only the insulated resistors of the semi-precision type with an accuracy
(Continued on page 762)

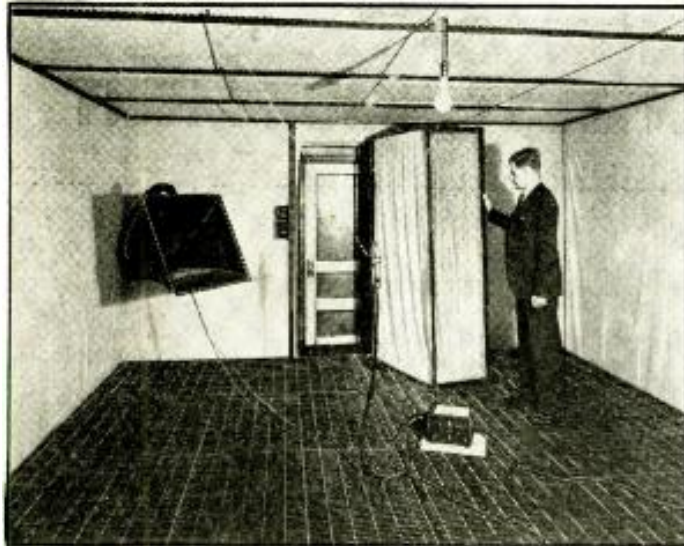
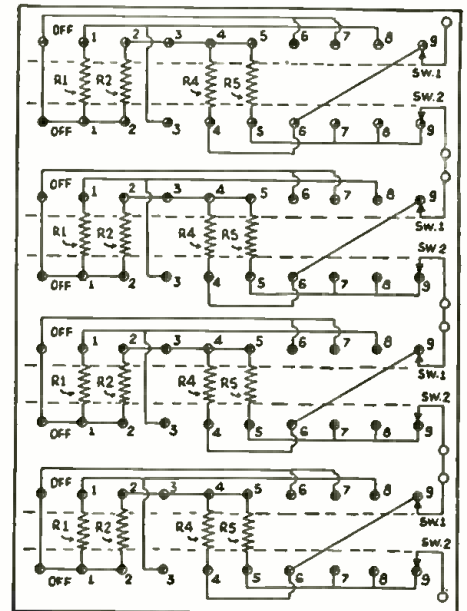

(Bell Labs. Photo.)

In the Bell Telephone Labs. a specially-equipped room has been set up for acoustical measurements. The walls, ceiling and floor are covered by 16 layers of cloth separated on steel frames, to absorb all sound which strikes the boundaries of the chamber.

A COMPLETE P.A. system is a combination of several essential parts. To determine the number and size of these parts, it is convenient to start with the speakers and determine how many are needed, and the power required to produce proper volume and distribution of sound. Installations *outdoors* require about twice as much power for a given-size audience as is required *indoors*. The outdoor audience is usually spread over a larger area and very little reflected sound is depended upon to re-enforce the amplified sound in indoor installations.

Figure 1 (in Part I) shows how the number of listeners, and the volume of the room will affect the amount of power required for a given number of speakers. A compromise

INSTALLING INDOOR AND OUT- DOOR P. A. SYSTEMS

This part of the discussion deals particularly with acoustics from a practical standpoint.

E. L. RICHARDS AND J. P. HANAN
PART II

between the values represented in these two charts will give the approximate power required for the average indoor installation. For example, if the acoustical properties are good, where there is just enough reverberation to allow a moderate amount of power to give good audibility throughout the entire area served, the curve marked "favorable" is used. From Fig. 1A, an audience of 4,000 should be served with 14 W. Assuming the volume of the room is 160,000 ft., we find in Fig. 1B that 16 W. is recommended. Adding 16 and 14 W., we get 30 W., which when divided by two gives 15 W. This is the minimum amount of power that should be used. (An additional small amount of power should be counted-on to overcome transmission, padding, and external-attenuation losses, as discussed elsewhere in this issue. —Editor)

Where there is a large amount of extraneous noise and excessive absorption, the "unfavorable" curve must be used. The amplifier installed should have sufficient power to serve for unfavorable conditions, but must have suitable gain controls and indicating devices so that the operator can keep

(Continued on page 759)

OFFICIAL RADIO SERVICE MEN'S ASSOCIATION, INC.

MEMBERS' FORUM

A department devoted to members and those interested in the Official Radio Service Men's Association. For mutual benefit, contribute your kinks, gossip and notes of interest to Service Men, or others interested in servicing.

CAR-RADIO IMPROVEMENTS

RADIO-CRAFT, ORSMA Dept.:

A considerable improvement in performance of car-radio sets may be had by retuning the antenna trimmer after the set has been installed and connected to the car antenna.

In some cases it is also necessary to slightly retune the 1st-detector trimmer.

JOHN E. MASON,
Armona, Calif.

CLEVELAND MEN VOTE "OK"!

RADIO-CRAFT, ORSMA Dept.:

In reading the suggestion by Paul G. Freed in the March issue pertaining to "Association Exchange" may I also say that I am highly in favor of such an idea.

Although I am not a member of ORSMA, I am a regular reader of this page and am very much interested in other associations throughout the country.

Please count my vote in on this suggestion, and may we, The Radio Technicians Association Inc., of Cleveland, Ohio, be permitted to submit material in support of something like this.

R. H. GRAY,
Cleveland, Ohio.

This letter from Mr. Gray, who is secretary of the association, pertains to Mr. Paul Freed's suggestion of the exchange of information on

various publicity ventures which have met with success. In this way mutually helpful information may be circulated.

TINFOIL JOINTS

RADIO-CRAFT, ORSMA Dept.:

As I am an old telephone man, I cannot quite agree with the article published on page 497, Feb., 1936 issue of *Radio-Craft*, by Louis B. Sklar. The putty with its oil is an insulator and would cover the whole surface of the joint in a short time.

A much better way is to place over the joint a strip of tinfoil from a gum wrapper and then cover with tape.

Years ago, before the telephone company used connectors, they used this method, and I have taken joints apart for inspection after years of use, and they were as bright as when they were

made, which shows the effectiveness of the system.
H. W. GREENN,
Bradford, Pa.

When Mr. Sklar dropped in from "Philly" to see us and talk over some of his contributions to *Radio-Craft*, some time ago, this old telephone method of making weatherproof joints was discussed. It was pointed out by Mr. Sklar that joints protected by putty in the novel manner he describes have lasted over periods of several years without seeming deterioration; at the same time, certain conveniences were afforded.

"BEST SERVICE PAPER"

RADIO-CRAFT, ORSMA Dept.:

As a reader of *Radio-Craft* since December, 1929 (I have all copies on file), and also as a
(Continued on page 754)

This power supply and neon condenser tester is used by Kirkwood Radio Labs. of Atlanta, Ga. It is mounted in panel form. A voltmeter connected directly across the condenser to be tested shows drop, while other switches are provided for testing paper condensers of all values.

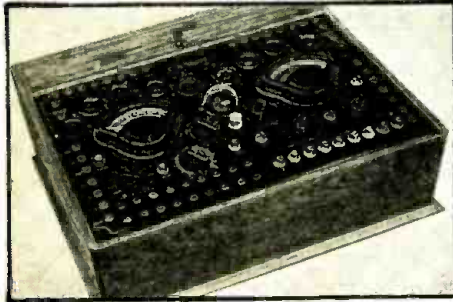
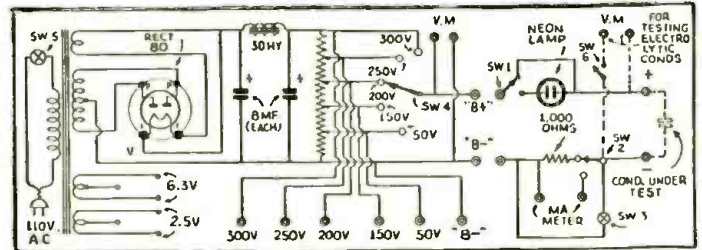

THE DESIGN OF MODERN TEST EQUIPMENT

A really comprehensive discussion of design problems relating to service instruments; Tube testing is considered.

SAMUEL C. MILBOURNE PART III

WHEN VACUUM tubes were first introduced to take the place of crystal detectors for radio reception, the popular mind considered a tube as being operable as long as the filament of the tube was intact and capable of being illuminated. Even today, there are radio users who question the wisdom of a radio man who recommends the replacement of a tube which is "still burning," and Service Men often receive calls from customers who assure them that "the tubes are all right, because they are all burning."

This popular misconception of the index of operating qualities of radio tubes in glass envelopes is excusable for laymen, of course, because they quite naturally associate radio tubes with incandescent lamps which are designed for the primary purpose of illumination. It is natural to expect that *this popular misconception will not exist where metal tubes are used.*

The first tube testers were based on the incorrect idea that a tube was operable as long as the filament was intact, and were so designed that they were nothing more than continuity testers of the filament circuit. It is probable that most "old timers" of the radio servicing profession can remember an old home-made tube tester with a flashlight bulb in series with the filament circuit. If the flashlight bulb was illuminated when a tube was inserted in the tester socket, the tube was "good"; if the flashlight bulb failed to illuminate when the customer's tube was "tested," the customer was convinced that he would have to pay \$7.50 (or more) for a new tube.

Those were the first "English-reading" tube testers!

The professional radio man knows that the illumination of an element of a radio tube is only incidental to its primary purpose of emitting electrons which are attracted or repelled by other elements in the tube, and that the degree of
(Continued on page 756)

Fig. 6. Chart and circuits for fundamental emission tests.

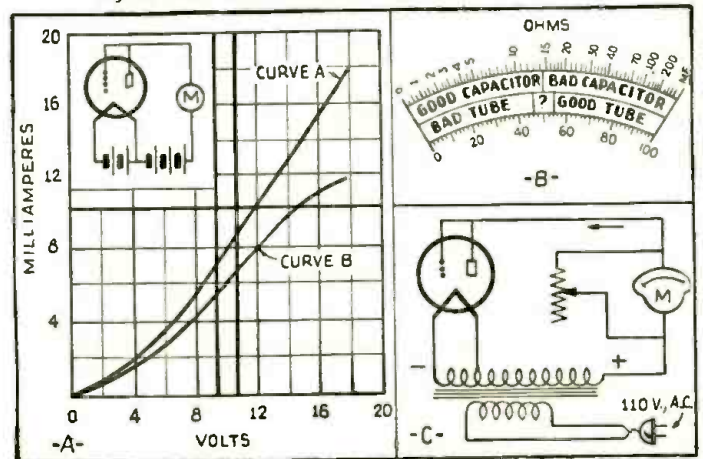

DESCRIPTION OF A NEW FREQUENCY WOBBLER FOR SET ALIGNING

The correct aligning of high-fidelity receivers requires some means of visually adjusting the tuned circuits to give a flat-top waveform. This new "vibrating-reed condenser" wobbler or "modulator" unit makes this possible.

ALLEN B. DU MONT

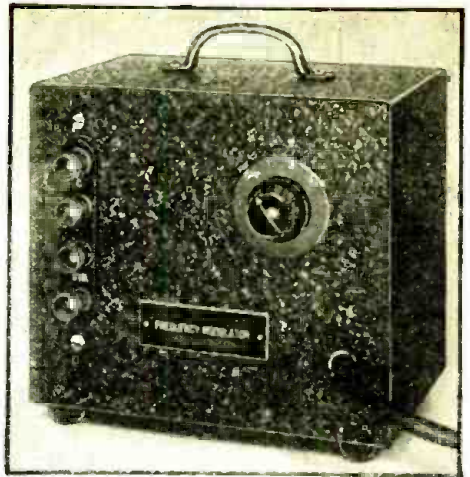

THE NEW instrument described here for the first time in any radio magazine is designed to operate in conjunction with an oscilloscope and service oscillator and is used for obtaining visual resonance curves of R.F. and I.F. circuits.

The unit consists of a vibrating reed, which, together with a stationary plate, acts as a low-capacity variable condenser. It is set into vibration by the 60-cycle line current. This is a contrast to the previous frequency wobblers which used motor-driven condensers.

The amplitude of vibrations can be varied by the tap-switch on the unit and in this way the range through which the capacity varies may be increased or decreased. The range is roughly 5 to 75 mmf., in 3 steps.

The frequency-wobbler capacity should be connected across the tuning capacity of the service oscillator.

The variation in the frequency of this service oscillator is caused by the variation in the capacity between the vibrating reed and a stationary plate.

Let us assume that this frequency varies between 600 and 620 kc. If a fairly selective radio receiver, tuned to 610 kc., is connected to receive this signal, every time the frequency sweeps

through 610 kc. the plate current of the detector will respond to this signal. In the case of a diode detector the voltage across the diode load resistor goes through an increase and decrease. The shape of the curve representing this varying potential is shown in Fig. 1A.

This curve was obtained by connecting the voltage across the diode load resistor to the amplifier in the oscilloscope, which fed the voltage to the vertical deflection plates. At the same time the horizontal deflection plates received a sweep voltage from the sweep oscillator in the oscilloscope. This sweep in horizontal direction was made at the same rate as the frequency of the service oscillator was changed. In other words, while

the frequency changed from 600 to 620 cycles, the sweep moved from one end of the screen to the other. Had the receiver been more selective, the curve shown on the above figure would have been narrower, since a lower amount of detuning of the service oscillator would have dropped the potential more quickly to zero. In this way the selectivity of the receiver is represented on the curve. It is well-known by anyone in the radio field that for high-quality reception the selectivity curve of the receiver (ordinarily) must have a square top. Without the above-described method it

would be difficult to find out how nearly the receiver answers this requirement.

In testing and aligning receivers the following procedure may be followed. Connect the frequency wobbler in parallel with the service oscillator condenser; connect the service oscillator to the antenna and ground posts of receiver under test; connect the A.F. output of the receiver to the input of the amplifier in the oscilloscope; and, finally, connect the synchronizing impulse from frequency wobbler to binding posts on the oscilloscope intended to receive a synchronizing impulse.

These connections are shown in Fig. 2.

The frequency wobbler varies the frequency at the rate of 120 times or cycles per second. Most receivers have sufficiently good response characteristics to pass a 120-cycle note without distortion.

(Continued on page 764)

FOR THE FIRST TIME IN ANY RADIO PUBLICATION

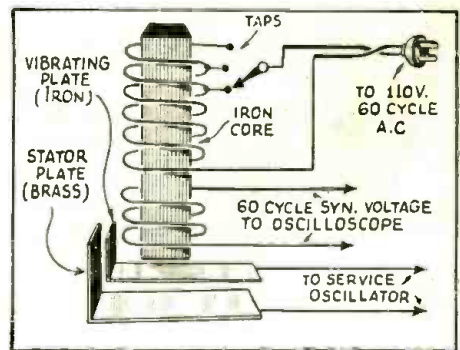

Fig. 3. The action of the wobbler.

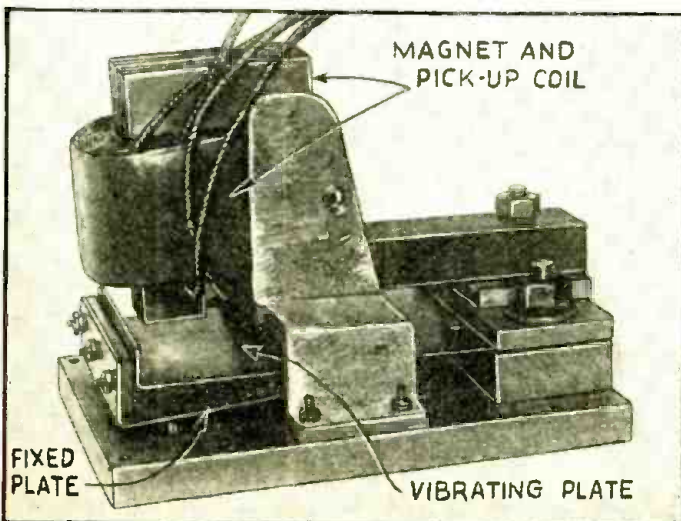
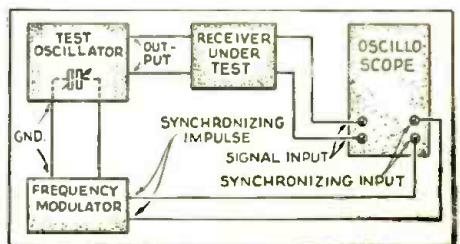
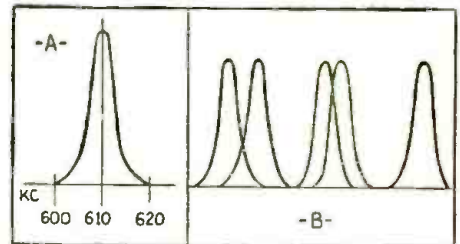

Fig. 1, right. Oscilloscope wave formations obtained in the aligning procedure.

Fig. 3, left. The interior of the wobbler showing the tapped electromagnet and the plates of the vibrating condenser.

Fig. 2, lower right. The block set-up required. Note that the frequency modulator or "wobbler" shunts the oscillator tuning condenser.



RADIO PICTORIAL

Train radio system; "flying headquarters" in the U. S. Army; new process brings permanent high-fidelity records to public; meteorological reports by radio from balloons.

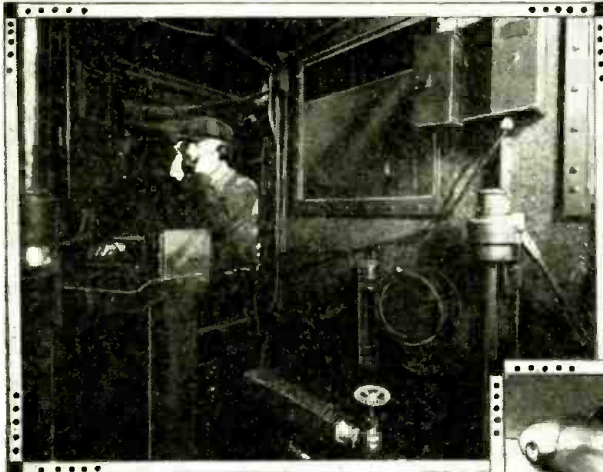

ARMY FLYING HEADQUARTERS. This fast "ship" carries no armament, but has offices for Maj.-Gen. Andrews and his staff. A radio station with a radius of about 750 miles on voice, tone or C.W. is included in the equipment. Private Inman is shown. (Harris & Ewing)



TRAIN RADIO. This radio system operates with a power of 25 W. on a wavelength of between 7 and 10 meters. (Westinghouse)

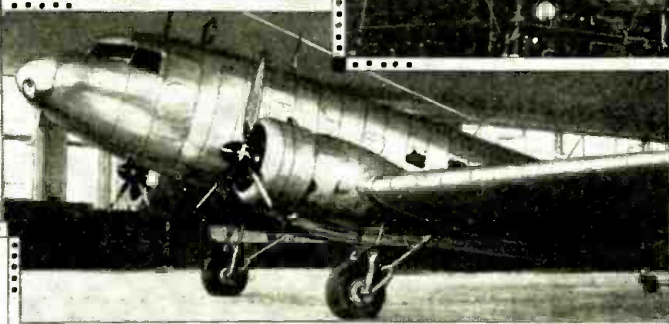

PERMANENT NOISELESS RECORDS. After a long search, Captain Richard Ranger has perfected a system of making record blanks which will enable the home recorder to make perfect noiseless recordings. With a



sound level of -30 db. the noise is only -86 db. The blanks are now made in large numbers, and the 12-in. size sells for about 85 cents. An aluminum disc is coated with a special new lacquer, which is flowed on automatically to an absolutely even finish. Heat and humidity controls in the coating machine enable rapid hardening of the coating, which is so hard that it must be temporarily softened before cutting. This is done by exposure to fumes of a solvent, furnished with the blanks. (Halbran)

RADIO METEOROGRAPH. The latest equipment used for investigation of conditions in the upper air, with radio as the recording means. Above are the balloons used to carry the tiny (Continued on page 755)

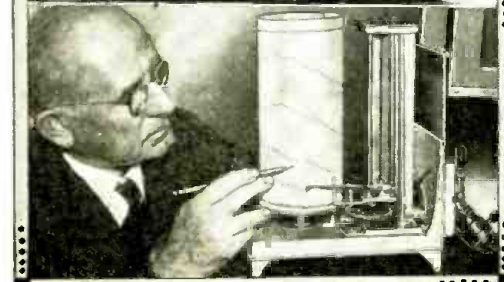
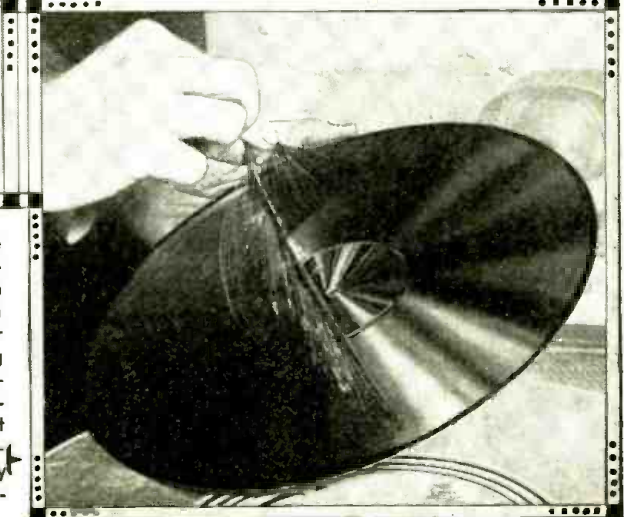
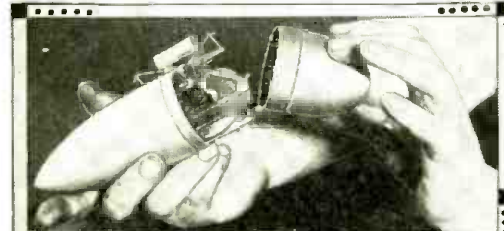
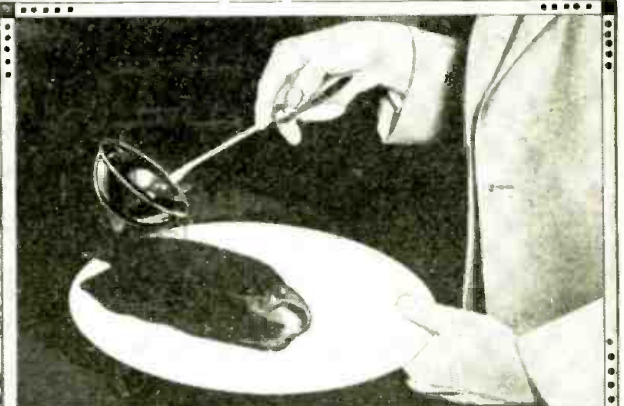

The new records may be cut by ordinary means after softening, after which they harden, and will then last indefinitely. The upper photo shows lacquer being flowed on a disc, the process being done automatically in production. At right the operator is removing the shreds left by the cutting needle, immediately after recording.

SCOTLAND YARD'S NEW RADIO SYSTEM



RADIO IN SCOTLAND YARD. England's famous crime detection center has a very complete radio system. At left is a patrol motorcycle with the officer receiving a message. The rod on the sidecar is the aerial. Lower-left, map tables, where the location of every motorized unit of the system is marked by the small blocks. Right, transmitter operating room, where signals are sent to cars, and also to Yard offices in Canada and Australia! Lower-right, interior of radio-equipped "Q-car".

(Swift Photos)

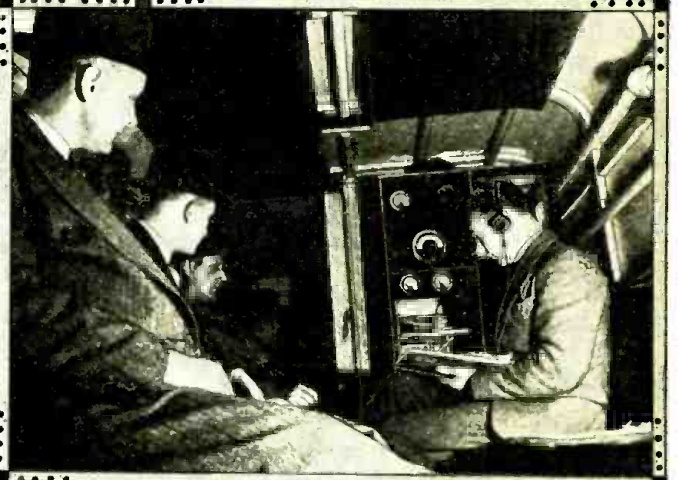
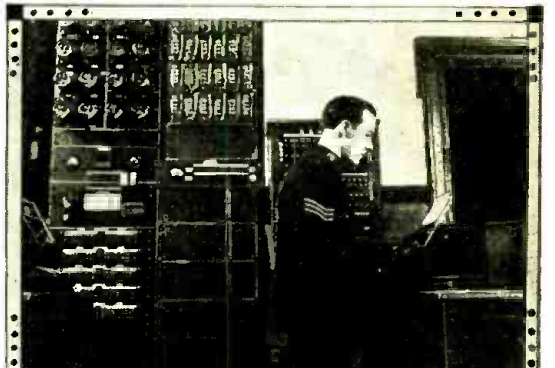

NEW DEVELOPMENTS IN 7-METER POLICE RADIO

Increasing municipal, county and state police budgets are opening up a new market for 2-way installations.

M. L. PRESCOTT

RADIO AT ultra-high frequencies is one of the newer tools now at the disposal of police organizations for use as an aid in the prevention of crime and the apprehension of criminals.

The utility of radio in connection with routine police work has been recognized for a number of years. Shortly after the advent of radio broadcasting enterprising individuals and commercial manufacturing organizations undertook the development of radio equipment suitable for meeting the needs of the police field. As might be expected, a number of technical obstacles were encountered which, together with the limited field of application and the scarcity of frequencies available, tended to restrict sales. While a gradual increase in the number of installations was recorded during the latter years of the preceding decade, the number of police departments utilizing radio constituted a very meagre percentage of the total. The arrival of the depression in 1929 provided a serious setback to police radio in that it found municipal,

county and state officials unable to purchase the desired equipment due to low finances. With the gradual return to

(Continued on page 759)

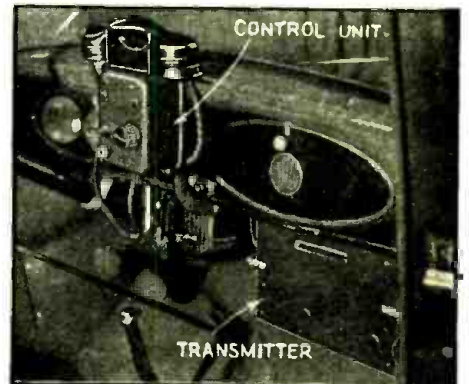
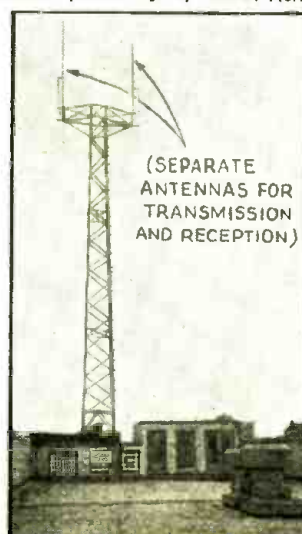
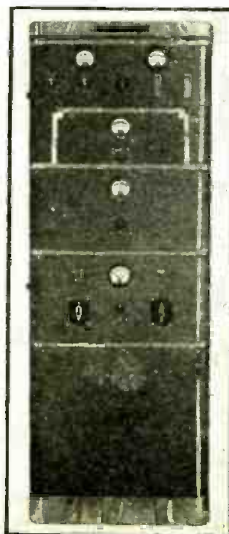

Fig. C. A 2-way installation in a police car.



(SEPARATE ANTENNAS FOR TRANSMISSION AND RECEPTION)

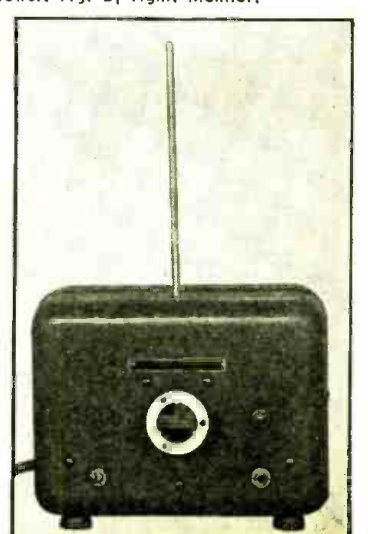
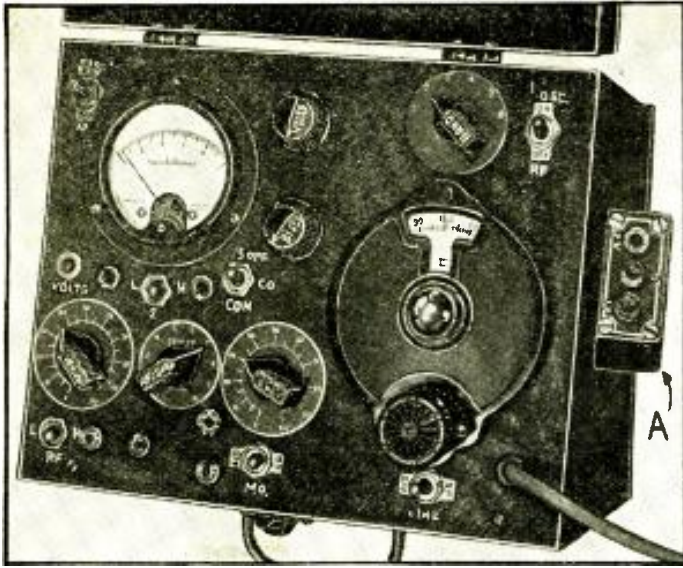

Fig. A, left. Transmitter panel. Fig. B, center. Aerial tower. Fig. D, right. Monitor.



MAKING A PRECISION ALIGNING UNIT

A correctly designed oscillator is one of the most useful devices that the Service Man can have. This one covers frequencies from 100 to 60,000 kc., with audio modulation from 25 to 7,500 cycles. Both R.F. and A.F. are readily controlled over wide ranges.

CANIO MAGGIO

PART I

NUMEROUS ARTICLES have appeared in various publications regarding the complexities that the advance of tube and circuit design have brought about. Having encountered these complexities, the writer has developed testing equipment (such as the "Service Man's Companion" published in the July, 1935 issue of *Radio-Craft*) designed to facilitate localizing the defects which such complexities engender.

Through experience, the technician, Service Man and others in the radio field, will assert that the service *signal generator*, or what is generally known as a "service oscillator," is the most important and useful equipment next to the analyzer.

Years ago a service oscillator was used when a good signal from a station was not available, whereas today, a station is used when a good service oscillator is lacking.

Before going into details about the design and the construction of the unit illustrated, it is best to explain certain principles and measures that were employed in its design, so that certain principles or incorporated features will be fully comprehended by the reader whether he be a technician, Service Man, or a novice.

The most practical and economical circuits that are used in oscillators for

best all-'round results are the Hartley and the tickler-feedback type, Figs. 1A and B, for such circuits are capable of supplying a relatively large output in proportion to the nominal plate voltage that is required to establish oscillation. When such circuits are designed to generate an R.F. current, it is of the utmost importance to keep the waveform at a uniform level or capable of generating a pure sine wave.

The frequency stability of an oscillator, is of the utmost importance, because it is upon this that the accuracy of the oscillator depends.

DETERMINING OSCILLATOR STABILITY

One method for determining the frequency or amplitude stability (which are the same) is to observe the plate current of the oscillator as indicated on

a current meter. If the plate current is constant over the tunable band that it covers, the frequency stability is said to be perfect (a condition which is never achieved in practice) and equal to that ordinarily obtainable only from a quartz oscillator.

A second method for determining the stability is to transmit both the oscillator frequency, and a signal from a broadcast station, through an adequate tuning assembly. The zero beat of two sources should be "pure" (a single frequency, free from any other frequencies), so that the (crystal-controlled) modulated frequency broadcast by the station, should be heard for an indefinite time without the interference of the signal generator; in other words, as clear as if the signal generator was

(Continued on page 760)

Fig 1, below. Design considerations. Fig. 2, right. The circuit of the complete unit, with values. Note the combination of tubes to supply R.F. oscillation and mixing; A.F. oscillation; and power supply.

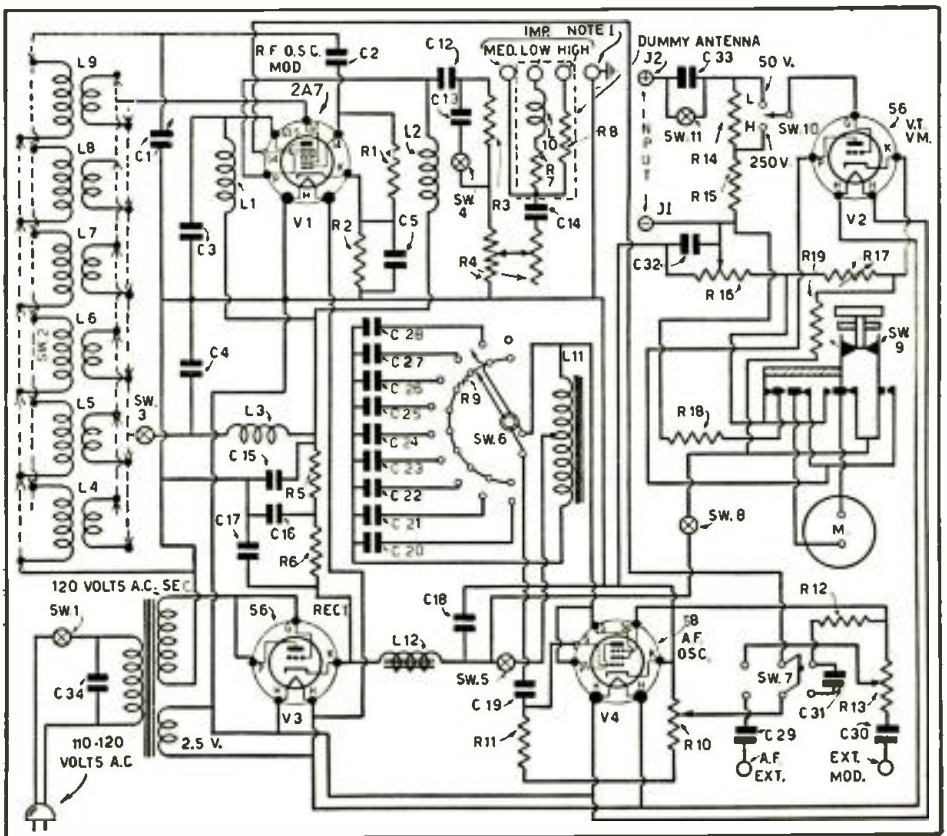
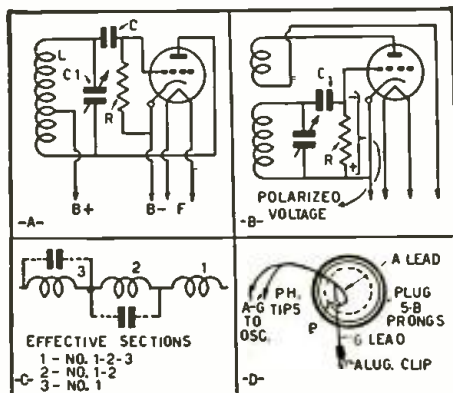

BUILD THIS BEGINNER'S 2-TUBE ALL-WAVE SET

The beginner will find this a fine set to start with in short waves—it is easy to build.

DONALD LEWIS

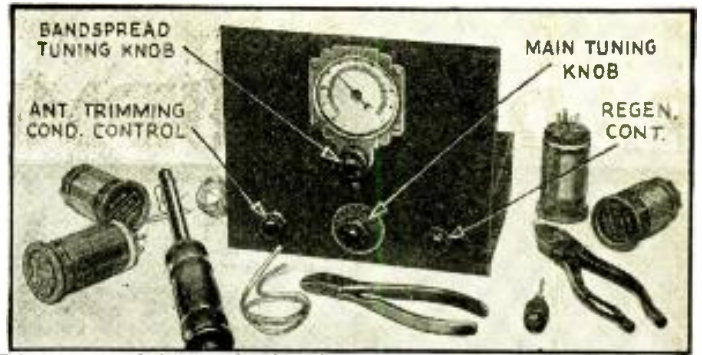

Appearance of the completed 2-tube receiver—note the use for each knob.

AS A PORTABLE or home receiver, this compact all-wave unit using two of the latest-type metal tubes will be found very effective. It has been designed so that it can be operated from either batteries (6-V. "A", and 135-V. "B"); straight "A" and "B" eliminator, or the familiar 25Z5 A.C.-D.C. eliminator.

The type 6J7 metal tube is used in the detector circuit. In the A.F. stage is a 6F6, used as a class A pentode power amplifier.

The entire receiver has been built on a steel chassis 6 x 8 x 2 ins. high. The panel is only 7 x 8 ins.

To provide complete efficiency on the short waves, the essential band-spread tuning system has been incorporated, using a 20 mmf. condenser. This has been placed above the chassis and connected to the main tuning dial. A 140 mmf. condenser is used to tune in the particular channels desired. The band-spread condenser is then used to mag-

nify or spread out these channels. To provide selectivity and to increase the sensitivity a 20 mmf. condenser has also been incorporated, in series with the antenna circuit.

The impedance type of audio system is used to couple the 6J7 to the 6F6. The output, from the 6F6, on most stations of local and high-power nature, will be great enough to operate a loudspeaker. However, where loudspeaker volume is desired on all stations, a small amplifier can be connected to the phone terminals.

To control the volume, there is a 50,000-ohm potentiometer in the screen-grid circuit of the detector. One terminal of this 50,000-ohm potentiometer is connected in series with a 0.1-meg. fixed resistor that provides control-grid bias. Choke Ch.1, in the A.F. coupling circuit, may be the secondary of either an A.F. transformer or a microphone-to-grid transformer.

A set of 2-winding, 4-prong coils are used to provide coverage of the 17 to

41; 33 to 75; 66 to 150; 135 to 270, and 250 to 560 meter bands with a 140 mmf. condenser across the secondary of the coils.

Since this unit has been designed to operate from practically any type of power supply, a 0.1-mf. fixed condenser has been installed in the ground circuit. Be very certain that this condenser is absolutely perfect; a short here will cause plenty of damage, as you can well imagine! The R.F. choke in the plate circuit is a 2.1 mhy. unit having a capacity of 0.1 mmf., and a D.C. resistance of 35 ohms. With its universal-wound pies and the foregoing characteristics it was found very effective on both broadcast and short waves.

If the receiver is to be used as a portable unit, it can be installed in a small carrying case, either wood or metal. A 50-ft. antenna with a good ground will provide surprising results. In the home a longer antenna should be used if possible—say, about 100 ft., with a good ground.

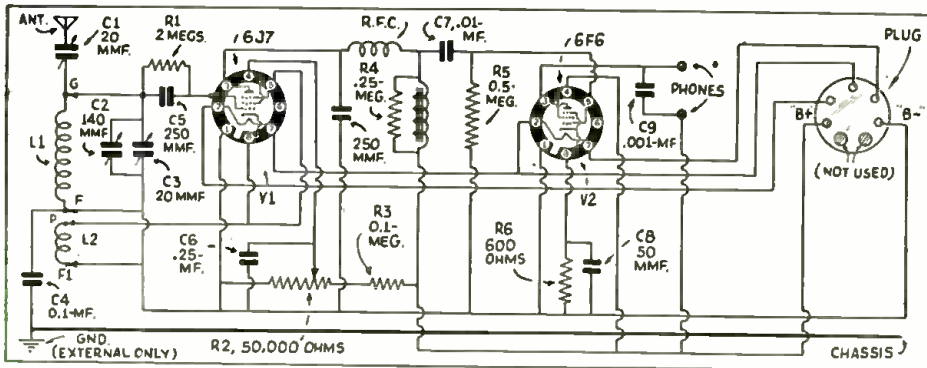
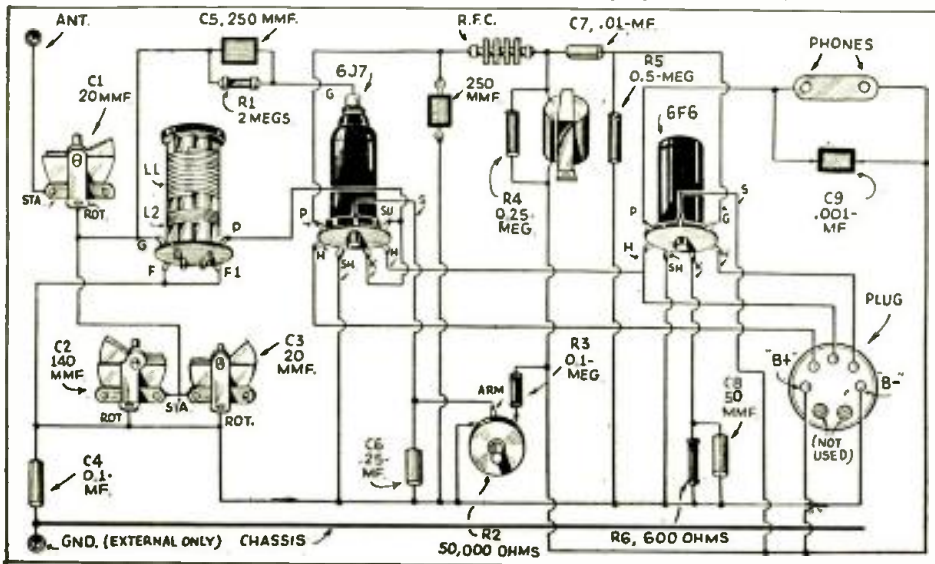

Fig. 1, below. The pictorial wiring diagram of the set. Fig. 2, above. The schematic.



LIST OF PARTS

- Two Hammarlund variable condensers, 20 mmf., MC20S, C1, C3;
- One Hammarlund variable condenser, 140 mmf., MC140M, C;
- One Solar fixed condenser, 0.1-mf., 200 V., C4;
- Two Solar mica condensers, 250 mmf., C5, C10;
- One Solar fixed condenser, 0.25-mf., 200 V., C6;
- One Solar fixed condenser, 0.01-mf., 300 V., C7;
- One Solar electrolytic condenser, 5 mf.,

(Continued on page 765)

Fig. B. The rear view showing layout of parts.

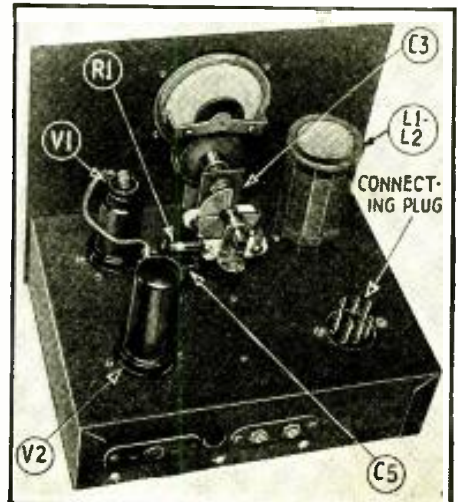

THE LATEST RADIO EQUIPMENT



An added utility is shown. (1009)

BLUE-GLASS MIRROR SET (1009)

A BLUE plate glass circular mirror is used as a front for this A.C.-D.C. superhet. receiver. The metal parts, including the knobs, are bright chromium finish. Wavelength-range, 550 to 6,000 kc. Includes tone control; and an adjustable antenna compensator. (Circuit appears in a Data Sheet in this issue.)

MOBILE SOUND SYSTEM (1010)

(The Webster Co.)

HERE is a sound system which may be used either on 6 V. or on 110 V. A.C. simply by replacing one power pack with the other; either or both power units are available. The system will handle crowds of about 5,000 people outside and 10,000 inside. Undistorted power output, 20 W.; total gain, 115 db. Includes two 12-in. permanent-magnet dynamic speakers with 25 ft. cables; also, battery and line cables. Uses crystal microphone. Tubes used: 1-6C6, 3-6A6s, 1-6E6; on A.C. an 83 is also needed.



Mobile sound system. (1010)

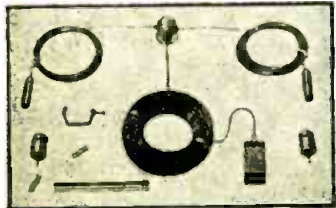

Newest all-wave antenna. (1011)

NEWEST ALL-WAVE ANTENNA (1011)

(RCA Mfg. Co., Inc.)

THIS improved all-wave antenna system comes to the user ready to install. No cutting or fitting is needed. Consists of: special doublet; transposed transmission line; antenna junction box; receiver coupling unit; and, all fittings needed for installation.

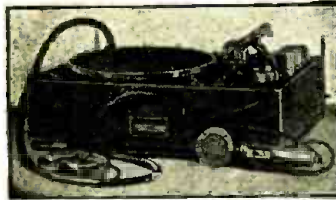

Portable P.A. unit. (1012)

PORTABLE P.A. SYSTEM (1012)

ALL POWER for this equipment is obtained from a 6-V. storage battery. Class A amplification is used throughout. Power output is 20 W.; gain, 100 db. One or 2 speakers may be used. Individual switches control filaments, high voltage, and turntable motor. A false bottom on the case permits it to be placed on the driver's seat and yet have the equipment run perfectly level. All accessories are connected by plugs and sockets. A heavy-duty battery is needed as the current drain is 16 A.. A crystal microphone is used.

COMPACT AMPLIFIER (1013)

(Lafayette Radio Mfg. Co.)

A GAIN of 116 db. in this amplifier makes possible the use of a velocity microphone, without external preamplifier. Two input jacks accommodate either high- or low-gain equipment. There are tone and volume controls, field supply for a 1,000-ohm speaker, fused power line, and an over-all steel cover. Power output is 5 W.; hum level is -51 db. below maximum output.

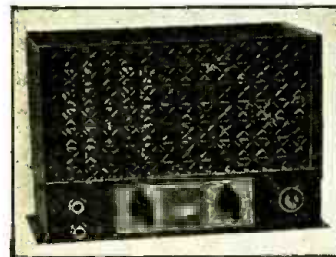

A compact amplifier. (1013)

Twin-hairpin car antenna. Designed to operate efficiently regardless of under-runningboard mud, etc. (1014)

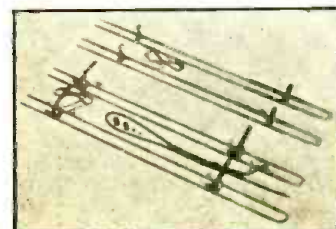

UNDER-CAR ANTENNA (1014)

(Ward Products Corp.)

SAID to be the first rubber-protected antenna ever offered to the public, this unit is completely pro-

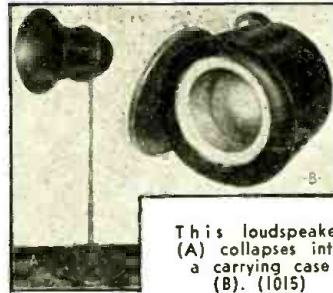

This loudspeaker (A) collapses into a carrying case (B). (1015)

tected from the elements. Included in the kit is a 66-in. length of low-loss lead-in wire. Signal pick-up is said to equal a roof antenna!

PORTABLE PROJECTOR (1015)

(Acme Sound Co.)

COMPACT to transport and easy to set up, this "folding" parabolic projector should fill a large need. Projector is spun of heavy aluminum; it is reinforced, and free from metallic resonance. Ask for 10-, 11-, or 12-in. (speaker) size. Fitted with suspension rings; a bracket screws onto a 3-piece brass stand that fits into a flange located in the lid of the carrying case which serves as a base, as illustrated at A. When packed, B, entire equipment measures only 13 x 18 ins. in diameter.



Around-corners screwdriver. (1016)

FLEXIBLE SCREWDRIVER (1016)

(Commonwealth Products Co.)

CORNERS not accessible to the ordinary screwdriver may be reached with this flexible unit. The shank is made of several layers of laminated steel wire, and does not have backlash under torsion. The knurled ferrule at the blade end turns freely and may be held in the fingers to steady the tip.



D.C.-A.C. inverter. (1017)

D.C.-A.C. INVERTER (1017)

LONG-LIFE vibrators are a feature of this line of inverters. (Swell for the multiferous services requiring a power-supply unit operable from a 6 V. storage battery.) Input voltages, 6 to 220 D.C.; power output, 50 to 200 W., at either 110 or 220 V., A.C. Filters are provided for quiet radio reception.



Matched car-radio coils. (1018)

CAR-RADIO COIL KIT (1018)

AN IRON-CORE antenna coil is included in this high-efficiency kit; all other coils are of the air-core type, as it has been found that only this one must be of the iron-core type to give sufficient over-all gain. The I.F. is 175 kc. These units are of small size, so as to fit in the compact car-radio sets now made.

(Continued on page 766)

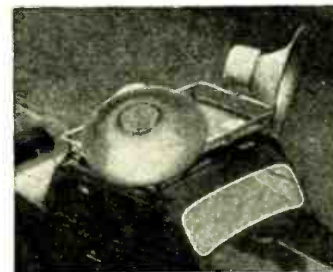

Above and below. A complete P.A. system installed in an automobile. The speaker baffles are impervious to moisture; the adjustable mountings are removable. (1019)

Dual-wave car set. (1020)

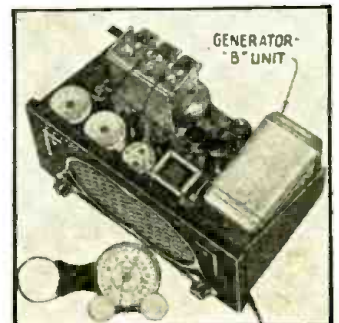

Name and address of any manufacturer will be sent on receipt of a self-addressed, stamped envelope. Kindly give (number) in above description of device.

UNDER-CAR ANTENNA KIT (1028)

(Philco Radio & Television Corp.)

HEAVY rubber insulation is used on the supports of this new and improved car antenna. It comes in 4 sections, 2 of which are fastened under each runningboard. Heavy cable is used to connect the parts on opposite sides of the car, while a shielded cable is used for the lead-in to the receiver. In most cases the antenna can be installed without drilling any holes. All connections are made at the factory. It will pay the car-radio specialist to look into this item as a money-maker in view of the speed and ease with which it may be installed on practically any car.

WIDE-RANGE "THEATRE" AMPLIFIER (1029)

THE DESIGN of a wide-range theatre-type amplifier is somewhat different from the usual P.A. amplifier due to varying acoustic conditions, such as size and shape of house, number of people, padding, etc., and the rather enormous variations in recording.

Theoretically, this latter should not be so, since the majority of present-day recording is through the wide-range or high-fidelity systems in the studios. However, there is a difference in the film stock itself; the actors' voices may vary; or, there may not be enough mikes to pick up the sound properly. For these reasons the theatre-type amplifier must be designed to compensate for the deep, muffled voices and the sharp tinny ones; at the same time it must be capable of presenting the music in its full richness, with sufficient power for the 2,000-seat theatre as well as the small nickel-odeon.

The high-fidelity amplifier illustrated contains 5 stages of A.F.

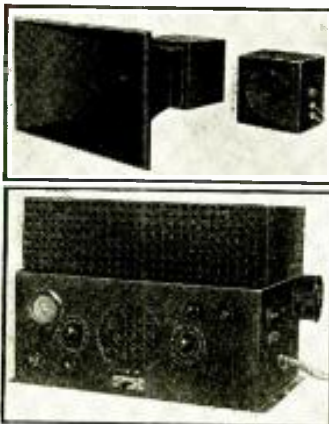

Below, schematic circuit of the wide-range theatre-type amplifier system. (1029)

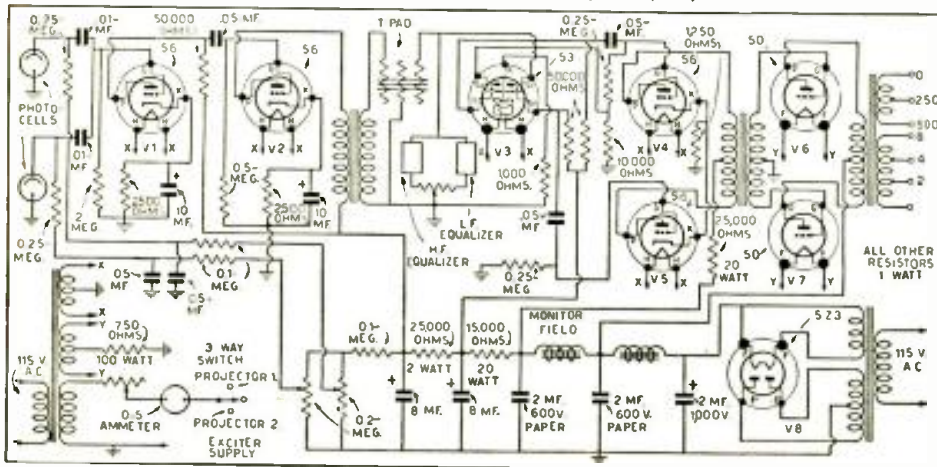

amplification, triple push-pull with phase inversion, dual tone control, a T-pad for distortionless volume control at any setting, exciter lamp and variable (0 to 90 V.) photo-cell voltage supply; a monitor speaker concludes the set-up. In order to use T pads for volume control a special transformer is used.

In the grid circuit of the third tube is incorporated a special, potentiometer-controlled tone equalizer; at one extreme of position the highs at 6,000 or 8,000 cycles can be stepped up between 15 and 20 db., and between 60 and 80 cycles, to about 10 db. (The incorporation of a tweeter speaker with its high-note emphasis often makes this necessary.) The undistorted power output is over 15 W., using a pair of 50s.

Since one of the prime requisites for theatre use is dependability, the amplifier here described incorporates oversize, heat-resistant condensers; one is a 1,000-V., oil-filled transmitter type.

CRYSTAL-TYPE "TWEETER" (1030)

(The Brush Development Co.)

AN IMPROVED reproducer of the crystal type has been designed to enable satisfactory reproduction of the higher frequencies. It must be used in conjunction with a dynamic or other speaker which will cover the lower frequency range. This crystal speaker or "tweeter" may be connected directly across the output transformer or the low-frequency speaker, but it should not have more than 25 V. across it. It is possible to hook almost any number of the units in series-parallel so that they may be used with A.F. systems of any power. As a rule, a single tweeter should not be used with a dynamic reproducer of more than 5 W. rating.

The twin-crystal driving unit is enclosed in a moisture-proof steel case, this in turn being mounted on the 4-in. speaker frame, as pictorially illustrated.

Referring to the schematic circuit, as previously illustrated in *Radio-Craft* the tweeter may be connected to the output transformer, by connecting speaker leads 1 and 2 to 3 and 4, through condensers C of about 0.5- to 0.25-mf. capacity. If it desired to use the tweeter on a voice-coil line and have a volume control on the tweeter, the complete circuit here shown is used.

Upper-left and left. Loudspeaker sound system and amplifier system respectively, of the "theatre" amplifier designed to meet varying acoustic conditions. (1029)

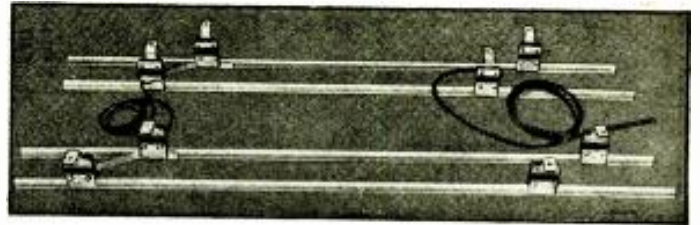

An easily installed double runningboard car-radio antenna. (1028)

IMPROVED UNDER-CAR ANTENNA (1031)

(Arthur H. Lynch, Inc.)

A NEW and novel type of automobile antenna that is said to have all the advantages and none of the disadvantages of the triangular-type previously announced in *Radio-Craft* by the same manufacturer, has just been announced.

The new antenna is of the inverted-V type. It attaches to the fly-wheel housing and shackle bolts on the rear axle in the manner here shown. There is no portion of the antenna, however, which runs parallel to the rear axle and for that reason breakage has been entirely eliminated. The two arms, extending from the fly-wheel housing, are made into the form of very stiff springs of extremely heavy wire. By this arrangement, the length of each leg of the antenna is actually more than 20 ft., regardless of the type of car on which it is installed. This feature provides very much more signal pick-up than would be possible with the ordinary single-wire triangular antenna.

The two long springs that form the legs of the inverted-V are encased by a moisture-dust- and oil-proof covering. This circumvents difficulties encountered in the ordinary runningboard type of antenna, due to an accumulation of mud, oil, grease and snow thrown up by the wheels.

In contrast to the earlier type of triangular antenna, the new type can be used on Fords and all other cars, and its performance is especially good on those cars with turret tops. Automotive radio Service Men who operate on the basis that "time is money," are advised that the installation time for this particular antenna, which is marketed in completely-assembled form, is said to be only about 10 minutes.

(Continued on page 767)

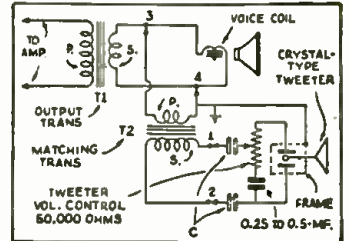

Above and below. Photo and circuit, of crystal tweeter. (1030)

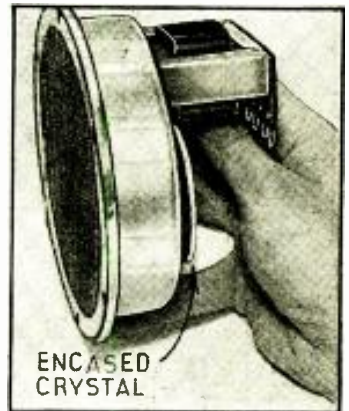

ENCASED CRYSTAL



Above. New car antenna. (1031)

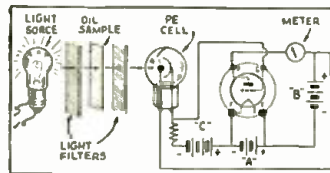
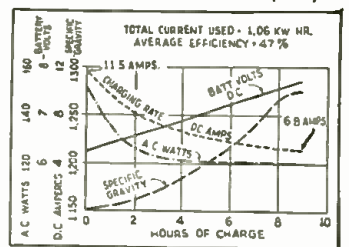

Upper- and lower-left. A photo-cell type of oil tester is shown. (1032)

Upper and lower-right. Adding chargers raises the charging rate. (1033)

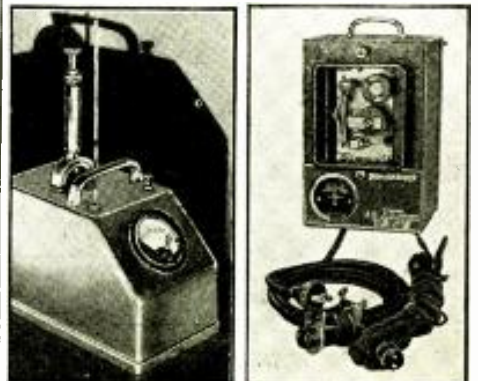

SPARTON MODELS 566 ("BLUEBIRD" MIRROR), 506 AND 594 A.C.-D.C. 5-TUBE 2-BAND MIDGET SUPER.

(Ranges—550 to 6,000 kc. in 2 bands; A.V.C.; illuminated dial; dynamic speaker; tone control.)

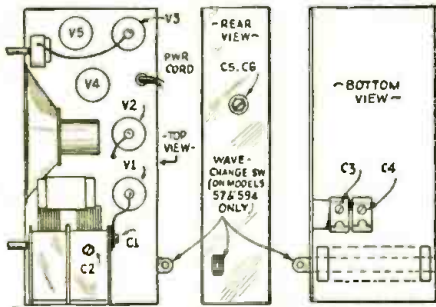

Above is a drawing of the trimmer (and other component) locations of this receiver.

This A.C.-D.C. compact receiver should be tested for proper voltages at a line potential of about 119 V. The antenna should be disconnected and the volume control turned on full, with the wave-band switch in the short-wave position. A variation of plus or minus 15 per cent is allowable on all readings.

Tube	Plate	S.-G.	C.-G.	Cathode
V1	115	115	15	22
V2	115	115	—	1
V3	—	—	—	0
V4	107	115	0	0
V5	118	—	—	117

All above voltages are measured to ground. Alignment should be made with an oscillator which can cover a range of from 172.5 to 1,710 kc. If the oscillator does not have a 0.1-mf. condenser in the antenna lead, such a condenser should be added. The lead should be connected to the cap of V1, and the other lead grounded to chassis. An output meter must be connected from plate of V4 to ground. Tune service oscillator to 456 kc., turn the set condenser all the way out of mesh, and adjust the I.F. transformer condensers. Set the station selector knob at 540 kc. and make sure the condenser rotor plates mesh evenly with the stator plates. Then align the set at 1,500 kc., after having first set the service oscillator at this frequency. Again align at 900 kc. on the set dial.

Alignment should also be checked at 600 kc., 550 kc., and 1,710 kc. The plates of the oscillator-section of the gang condenser may need to be bent slightly to attain alignment at these various frequencies. Also, after the set has been installed and connected to the antenna with which it will be used, the antenna series condenser should be adjusted for best receiver performance. This condenser will not need realignment unless the set is used with a different antenna.

The short-wave band may be checked by tuning the service oscillator to 1,500 kc. This frequency should be received at about 540 to 600 kc. (51 to 60 on the dial) when the wave-change switch is in the short-wave position.

The circuit is more or less straightforward throughout. The tube V4 gets its bias from the voltage drop through a section of the filter choke. When changing to short waves, the detector grid coil is cut out of the circuit, the grid then being untuned. (Set is illustrated in Latest in Radio department.)

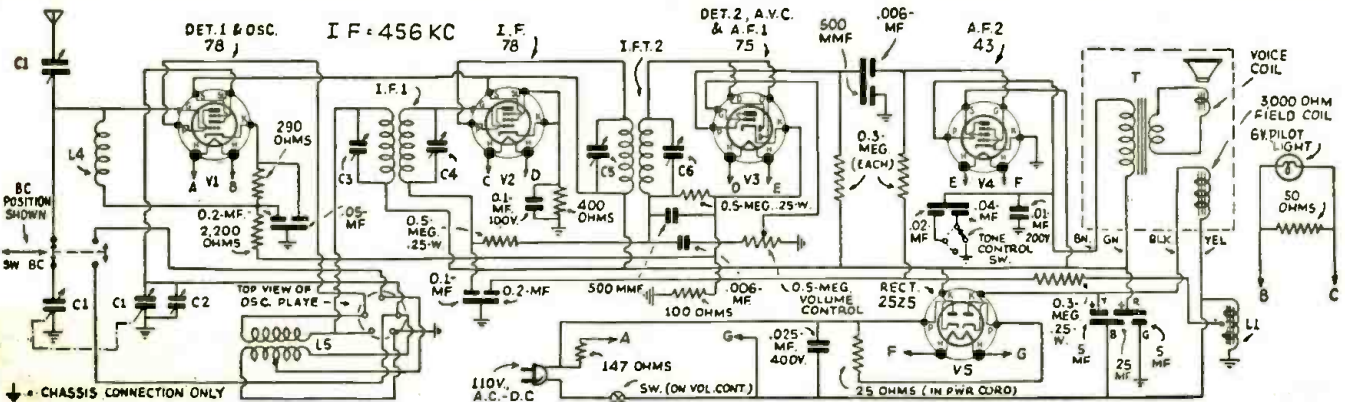

ATWATER KENT MODEL 776 6-TUBE AUTO RADIO

(Tone control; illuminated remote control; noise suppression; A.V.C.)

The operating voltages for this receiver are as follows, all measured to ground:

Tube	Plate	S.-G.	C.-G.	Cathode
V1	210	75	2	6
V2	215	80	2	2
V3	210	75	1	5
V4	—	—	1	—
V5	190	200	1	12
V6	rectifier	—	—	—

*In early sets, the upper cathode resistor of V4 is 5,000 ohms with a voltage drop of

4 V. and the lower is 15,000 ohms with a drop of 10 V. In late sets, as shown, resistors are 10,000 ohms each, with a total drop of 12 V. Early sets also had a 0.1-meg. plate resistor for V4 with a drop of 55 V., making plate voltage 125 V. Voltage is much lower with the 0.25-meg. resistor shown. Early models do not have a tone control and the "A" filter circuit is slightly different than shown. The bypass condenser on the pilot light is 0.2-mf.

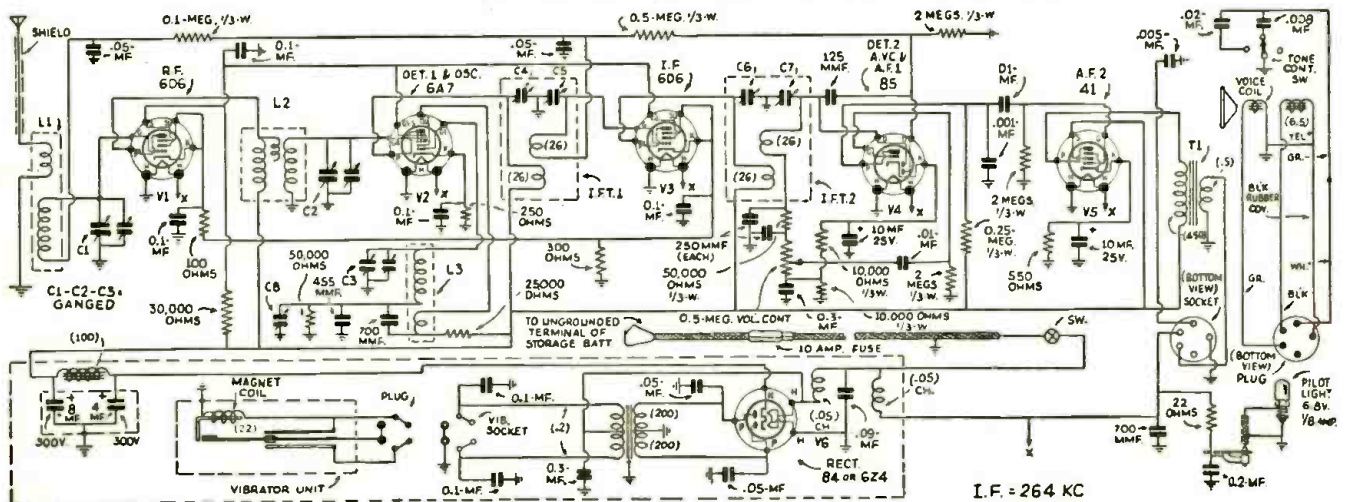
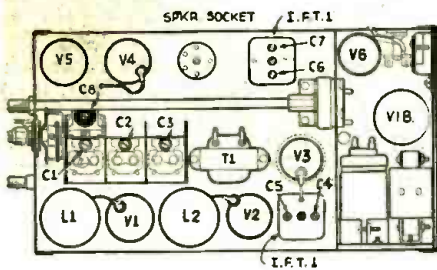

ELECTRONIC MUSIC FUNDAMENTALS

The principles underlying practical instruments are described. These are used with piano keyboards.

EDWARD KASSEL PART III

THE neon-tube tone generator employing a standard 110 V. neon lamp is shown in a simplified diagram. The circuit shown in Fig. 8 consists of an inductance in series with the condenser. A D.C. voltage supply charges the condenser through the resistance until the voltage across the neon lamp reaches the discharging potential. The glow in the neon tube will occur from the discharge of the condenser. This cycle will repeat over and over. By varying the capacity of the condenser or inductance a change in frequency is obtained.

A vacuum-tube tone generator is shown in the simplified diagram (Fig. 9) employing a thermionic-tube oscillator circuit. In order to vary the pitch of the vacuum-tube tone generator, a flexible metal band supported on the ends is pressed at a predetermined point against a resistance strip below.

Various designs can be made with this flexible band, in order to adapt it for practical fingering such as is necessary

for the conventional musical instrument.

HOME-MADE ELECTRONIC ORGAN

A small home-made electronic organ which anyone can build was shown in Figs. C and D in Part II.

In order to build such an organ, the constructor must obtain 12 shafts 1/4-in. in dia. and approximately 8 ins. long. Each shaft must be journaled, and well lubricated in bronze bearings, preferably without loose action. The speed ratio of one shaft to another, for example the C shaft to the C# shaft, is computed by the formula $12\sqrt{2}$. On the end of each shaft is a pulley of wood or metal, of approximately 1 in. face, and each pulley has a different diameter, starting from the C pulley which is 2 1/2 ins. in diameter and graduating down to the B pulley which is approximately 1 1/4 ins. in diameter. The C pulley on the C shaft will produce all the C notes, that is: C¹, C², C³, C⁴, etc.

In computing the diameters of the
(Continued on page 763)

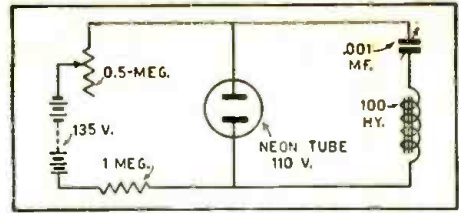

Fig. 8. The neon-type tone generator.

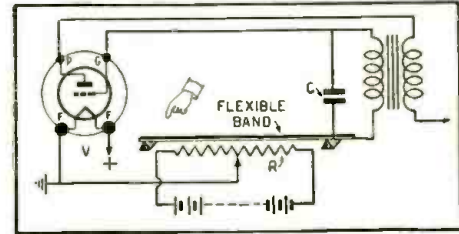
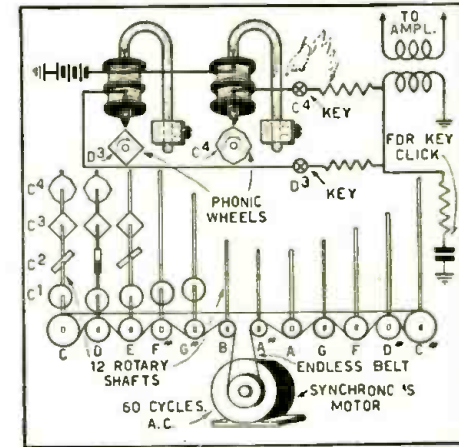
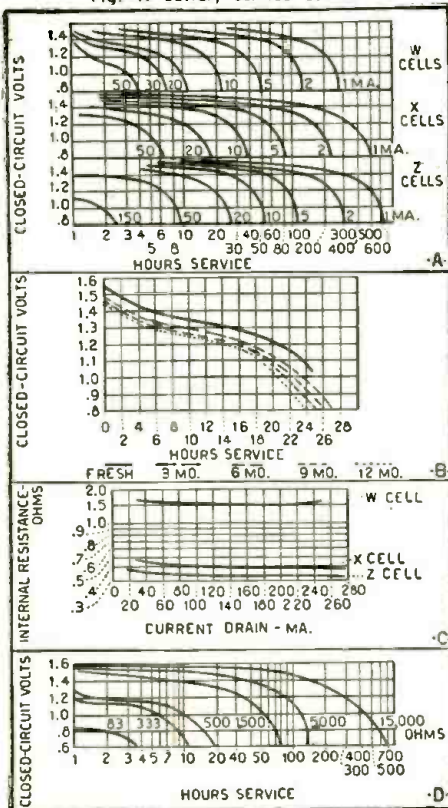

Fig. 9, above. A vacuum-tube tone generator.
Fig. 10, below. Tone wheel system.



NEW DATA ON PORTABLE BATTERIES

Fig. 1. Battery service curves.



Batteries for "pack" sets are in demand. Many misconceptions regarding their characteristics are given "the air!"
H. E. LAWSON

ALTHOUGH the dry battery appears to be fast dropping out of the picture in the general car-radio receiver class, the production of lighter and more powerful batteries, and the newer developments in portable transmitting and receiving instruments are steadily increasing, apparently in dependence upon one another. Because of the growing interest in this relatively new battery field and the existence of many misconceptions on the part of the average user, a few of the electrical characteristics of some of the smallest units are shown in the accompanying charts. The usual flashlight cells and carphone batteries have been commonly used for some time as an "A" supply and need not be discussed here.

STANDARD MINIATURE "B" CELLS

The 3 smallest popular cells from which "B" batteries of varying voltage



Fig. A. Ribbon battery containing 37 cells.

ratings are built have the physical characteristics given in Table I, as follows:

Cell Designation	Diameter (Inches)	Length (Inches)	Weight (Grams)
W	0.5	.97	8
X	0.5	1.34	11
Z	0.5	1.875	14

Some of the popular batteries made from them are described in Table II. Ribbon batteries with Z cells have been built with voltage ratings up to 315, these units weighed 7 lbs., 7 ozs. Ribbons 1 1/2 ft. x 2 ins. x 1/2-in. thick and containing 70 size "W" cells (105 V.) have been made for wearing on the operator's body.

SERVICE CAPACITY

Figure 1A illustrates the capacity in
(Continued on page 763)

INTERNATIONAL MODEL 77 SERIES (77-777-778-779) 7-TUBE DUAL-BAND RECEIVER
 (Ranges: 550 to 1,600 kc. and 5,500 to 15,500 kc. (19 to 55 meters); ballast tube; airplane dial; impregnated coils.)



With a line voltage of 118, and volume control full on, the following voltages will be read from tube pin to ground:

Tube	Cathode	S.-G.	Plate
V1	1	5	97
V2	3	97	97
V3	6	—	67
V4	0	97	85
V5	97	—	37
V6	ballast tube		

A 15 per cent variation is permissible in these values.

Some of these sets have a 25,000-ohm resistor between the plate resistor of V3 and the coupling condenser.

The 3 trimmers on the bottom of the chassis are, reading from the end of the chassis to the center, broadcast oscillator, short-wave detector, and short-wave oscillator. No trimmer is used across the B.C. detector coil.

The I.F. alignment is made with the service oscillator connected directly to the antenna, adjusting the first, then the second units. Then feed a very weak 1,400 kc. signal to the

antenna, and, with the set dial at 1,400 kc., adjust C4 for maximum. Resonance at 1,000 kc. and 600 kc. should be checked, and any needed adjustment made by bending the plates on C6. Short-wave adjustment is made at 15.5 mc. at which point C3 is adjusted. Next go to 12 mc. and adjust C2. At 6 mc., alignment is made by spreading or crowding turns on the S.-W. detector coil.

The 100-ohm resistor in series with the S.-W. oscillator plate lead is not needed and will be omitted in future models.

Poor sensitivity is almost always an indication of incorrect I.F. amplifier adjustment.

The 2 type 43 output tubes are used in parallel, with the cathodes grounded, and grid bias obtained from a voltage divider across the speaker field, which acts as a filter choke.

The ballast lamp (a type 60R 30 unit) has 2 sections, across one of which is shunted the pilot lamp (a 6 to 8 V., 0.15-A. bulb). Its use results in (a) a cool cord, (b) quicker heating time, and (c) compensation of line voltage variations.

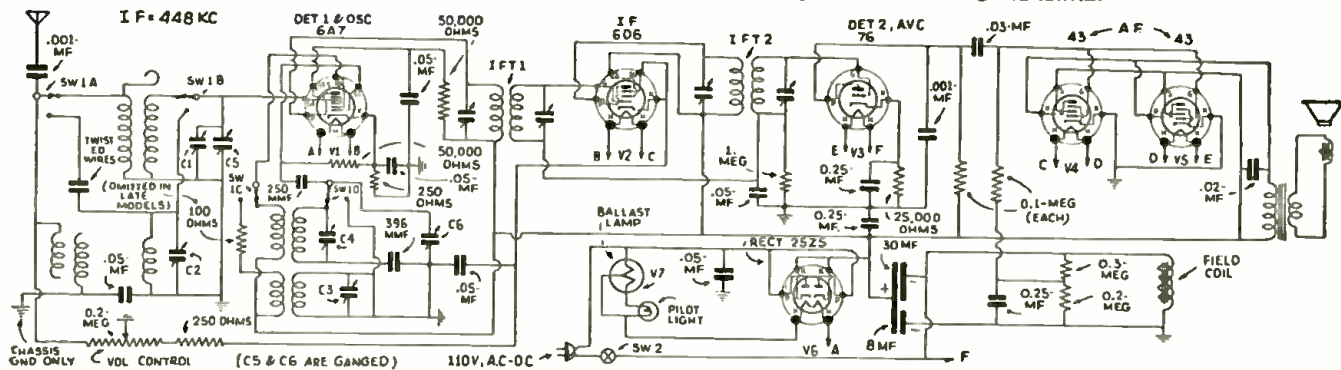

RCA VICTOR MODEL M109 "DE LUXE" 7-TUBE AUTO-RADIO RECEIVER

(Class B output; input noise filter; 2 units; tone control; 540 to 1,600 kc.)

The required operating voltages of this receiver are all shown on the detail drawing. All values are measured to ground, and most of them may be made with an ordinary high-resistance meter, while a few must be made with a V.T. voltmeter. The battery input voltage is 6.6 V. and volume control at max. with no input signal. Alignment frequencies are: 175 kc. for I.F., 1,400 kc. for R.F. and for osc. trimming, and 600 kc. for osc. padding. The power output is 3.5 W. undistorted, and 6 W. maximum, and current consumption is 7.2 A.

The grounding of the outer end of the antenna lead-in shield is very critical, since interference may be minimized by selecting the proper point of attachment to the car frame, the point having to be found by experiment.

The pilot lamp is carried in a socket which is attached to a heavy screw, the latter threading into the case of the control unit. This screw may be removed from the underside of the control unit, by use of a large screwdriver.

Ordinarily no ignition suppressors will be required with this set, since the general layout and the inclusion of the input noise filter make them unnecessary.

The use of an output meter is a necessity in the alignment of this receiver, and it may be connected to either the voice coil of the speaker or the output transformer.

To calibrate the dial, rotate the selector knob until the condenser is at full mesh, then remove tuning knob, loosen set screw in bushing and rotate until pointer is opposite the last radial line at the low-frequency end

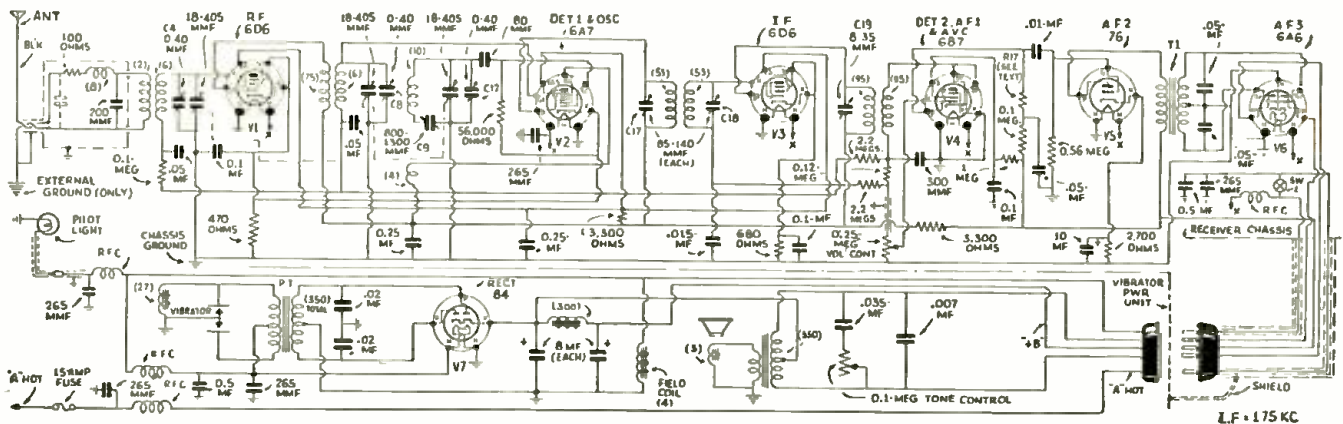
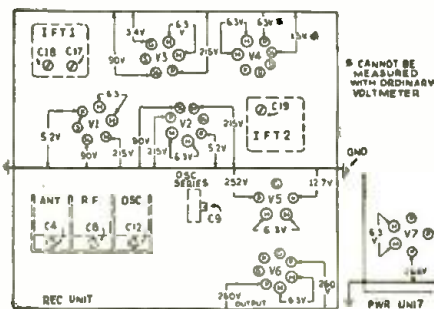

of the scale. Resistor R 17 measures 56,000 ohms.

NEW IDEAS IN "CAR" RADIO

(Continued from page 712)

start the engine. Of course, the engine can be run to charge the battery, but this is a wasteful method at best, and the camp is often set up in a remote spot where gasoline is not available for such use. A solution to this is seen in Fig. 2. One of the air-driven chargers may be temporarily mounted on the cabin, a handy tree, or almost any support that will raise it well in the clear. These chargers run on very light breezes and only need to be in operation a small time to charge a battery. A handy clamp may be devised, which will allow rapid fastening and removal of the charging unit; and a flexible cable connects to the car.

LATEST CAR-RADIO RECEIVERS

(Continued from page 712)

General Electric Model N-60. This receiver, Fig. D, incorporates a complete complement of metal tubes in a high-efficiency circuit. An iron-core antenna coil insures sufficient gain even with a relatively poor antenna, and taps are provided for high- and low-capacity antennas. A 6½-in. dynamic speaker is used to handle the power output, which is 4 W. The battery-current consumption is 7.5 A. Careful shielding and filtering make sparkplug suppressors unnecessary in most cases. A continuously variable tone control is placed on the front of the case.

Motorola "Golden Voice." Main feature of this receiver, Fig. E, is the inclusion of the "Magic Eliminode" with which it is possible to balance out motor noise and thus secure true suppressorless operation. Ten metal tubes are used. An iron-core antenna coil together with provision for tuning the set to any antenna make for exceptionally high signal pick-up. The sensitivity is so high that a control is provided to cut it down if so desired. (The "eliminode" was described in *Radio-Craft* last year.—Editor) (Diagram on page 715.)

The propellers usually used on such equipment are rather bulky, and would be unhandy to carry in a car. However a folding propeller, in which the blades could be quickly bolted to the hub would easily solve this problem.

NEW CAR-RADIO DEVELOPMENTS

(Continued from page 713)

A "TILTED SPEAKER" CAR SET
(Allied Radio Corp.)

(1040) The down-pointing speaker is also used in this set, but is inclined somewhat forward, towards the driver to project the sound outward in that direction. This construction eliminates those forms of audio distortion due to sound reflection from the floorboards directly back up to the loudspeaker. The separate control unit required by this receiver may be mounted in any of the conventional locations. It is a combination set, since both glass and metal tubes are used.

UNIVERSAL MOUNTING

(1041) This mounting bracket is adaptable to many different cars, and when used, makes it unnecessary to drill extra holes in the car dash. The set may be removed in a few seconds. Car owners may thus greatly reduce service charges by having this mounting installed, since the car-radio Service Man usually consumes a considerable amount of time, for which the customer must pay, in his effort to remove the set for servicing.

STATIC COLLECTORS

(1042) Unit A is for use on the front wheels, and B removes static (due to friction) from the rear wheels of one well-known make of automobile. The collectors are only necessary in certain cases, but all new cars of this make are equipped with the rear wheel units. The drawing shows how the front-wheel unit is fastened over the nut which holds the wheel on, and presses against the inner dust cap.

To install the rear collector, it is necessary to remove the wheel. The carbon brush rubs on a plate at the rear of the brake drum and so drains static from this wheel.

EACH TRIPLITT MASTER UNIT

Now IN ALL-METAL CASE

- STRONGER
- PERFECT SHIELDING
- NO INCREASE IN COST
- MORE PROTECTION FOR INSTRUMENTS

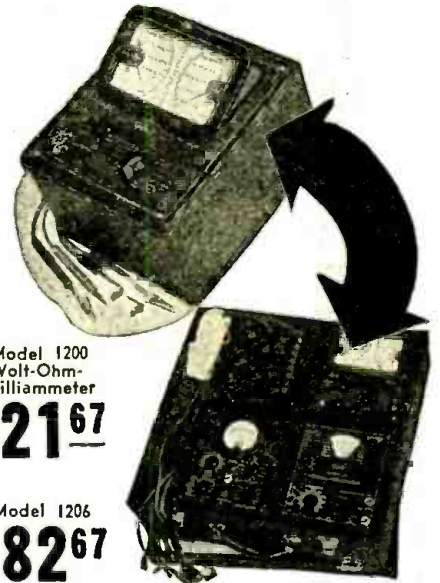

Model 1200
Volt-Ohm-Milliammeter
\$21.67

Model 1206
\$82.67

(Model 1206) Showing all four Master Units in Carrying Case. Can be purchased separately:

NO SERVICEMAN SHOULD BE WITHOUT MODEL 1200 VOLT-OHM-MILLIAMMETER

Reads D.C. 10-50-250-1000 volts at 2,000 Ohms per volt; 1-10-50-250-Milliamperes; 1500 Ohms; 1.5 and 3 Megohms; A.C. 10-50-250-500-1000 Volts.

Has these Triplitt features:

- SEPARATE A.C. AND D.C. METERS
- TILTING FOR ACCURATE READING
- OHMS SCALES SEPARATELY ADJUSTED
- LOW LOSS SWITCH
- ALL METAL CASE

	Dealer Net
MODEL 1210-A TUBE TESTER	\$20.00
MODEL 1220-A FREE POINT TESTER	8.33
MODEL 1231 ALL WAVE SIGNAL GENERATOR D.C.	26.67
MODEL 1232 ALL WAVE SIGNAL GENERATOR A.C.	26.67
MODEL 1204—LEATHERETTE CARRYING CASE WITH DEMOUNTABLE COVER	6.00
MODEL 1207 (same as Model 1206 except has A.C. Signal Generator No. 1232.)	82.67

See them at your jobbers. Write for details.

MAIL THIS COUPON:



TRIPLETT ELECTRICAL INSTRUMENT CO.
166 Harmon Drive, Bluffton, Ohio
Without obligation please send me
—More details on Model 1200.
—More details on Model 1206.
—New 1936 Catalogue.

Name

Address

City State

THERE'S A GOOD JOB FOR YOU IN RADIO
We Will Train You Quickly to Qualify

The servicing of modern radio receivers requires experts—men trained for this work are needed everywhere.

RADIO OFFERS BIG OPPORTUNITIES

Your possibilities of making money are limited only by your ability and skill. There is no room for the soldering iron "guesser." But you must be trained—the sooner you begin the quicker you'll cash in.

LEARN AT HOME

We will train you at home to service and repair radio receivers of all types. Invest for future success in R.T.A. training.

NO EXPERIENCE NEEDED

You need no previous experience in Radio. We show you how to make money almost from the start. Hundreds of men are enjoying the rewards of R.T.A. training.



FREE
of extra cost

This timesaving trouble-finder and circuit analyzer included.

Full details of this great opportunity are explained in a helpful book that is **FREE**. Send for it today. It will be mailed at once.

RADIO TRAINING ASS'N OF AMERICA
Dept RC-66, 4525 RAVENSWOOD AVE., CHICAGO

Please Say That You Saw It in RADIO-CRAFT

CROSLEY MODEL 6625 6-TUBE 3-BAND RECEIVER

(Ranges: 540 to 1,800 kc., 1,800 to 6,000 kc., 5,800 to 18,500 kc.; 6B5 output; doublet provision; universal transformers available.)

Operating voltages for this receiver are as follows:

Tube	Plate	S.-G.	C.-G.	Cathode
V1	265	100	0	5.0
V2	265	120	0	6.2
V3	0	120	0	2.6
V4	140	—	0	10.0
V5*	270	—	0	2.3
V6	350	—	—	—

*Output plate, 255 V. Anode grid of V1, 140 V.

All measured on 117.5 V. line with 1,000 ohms-per-volt meter on 500 V. scale, and receiver in operation with no input signal. All heater voltages are 6.3, except V6 which is 4.9 V. Readings may vary plus or minus 10 per cent of values given.

For alignment, a meter must be connected between the plates of V5 with a paper condenser of at least 0.1-mf. in series. The I.F. amplifier is aligned at 450 kc. with the lead from the service oscillator connected to the grid cap through a 0.02-mf. condenser, the grid clip being left in place. Turn the station selector to about 60 on the broadcast band, and the tone control to the left. Adjust trimmers C12 and C13 for maximum output. Transfer service oscillator lead to cap of V1, close C10 on I.F.T. 1 so that it is

moderately tight, and adjust C11 for best output. Adjust C9 similarly, then place lead from service oscillator to antenna post. Do not readjust C11. Set C10 to position of best output, and do not change C9 or C11.

For alignment of the broadcast and police bands (blue and red) a 250-mmf. condenser must be connected in series with the output lead of the service oscillator, and for the high-frequency band (green) a 400-ohm resistor must be used in place of the condenser. Each band should first be shunt aligned and then series aligned, where provision is made for the latter. Adjust C1, C2, C3, and C4, C5, C6 for highest output. Then readjust the station selector slightly to tune in the service oscillator best, and check C1, C2, and C3. Do not change the last 3 trimmers. Care must be taken not to align the circuits at the image frequency, which is 900 kc. less than the fundamental. To check, increase output of service oscillator 10 times or more and try to tune in the signal both at the frequency as indicated on the set dial and at approximately 900 kc. less than correct. If the set is properly aligned the signal will be heard at both positions, but much stronger at the correct one. Series alignment is made at 600 kc. on blue band and 2,500 kc. on the red

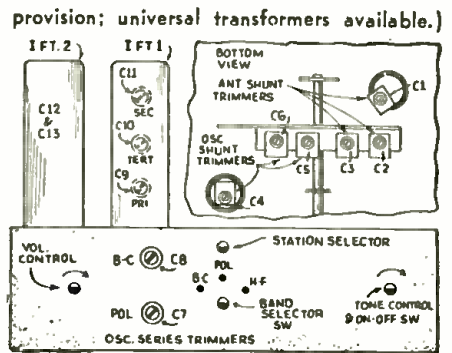

band. There is no series trimmer for the green band. Shunt alignment frequencies are 1,700 kc., 6,000 kc., and 18,000 kc. Best series setting will be obtained by rocking the station selector back and forth slightly while adjusting the trimmer for maximum output. The power consumption of this receiver is about 80 W., and the power output is about 3 W. Power transformers are made for use on any power supply up to 220 V., and from 25 to 60 cycles.

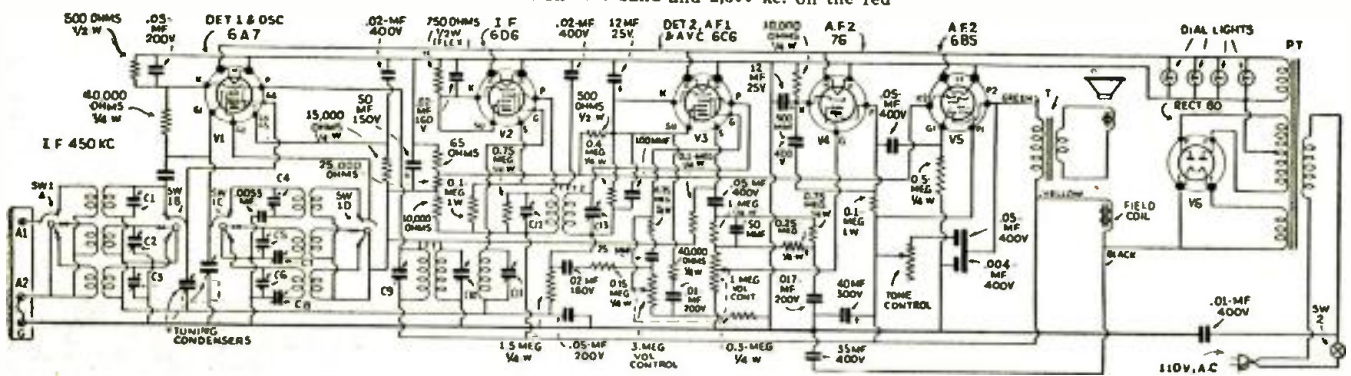

STROMBERG-CARLSON No. 61 4-BAND 7-TUBE A.C.-D.C. RECEIVER

(Ranges: 540 to 1,500 kc., 1,450 to 3,500 kc., and 5,600 to 18,000 kc.; speaker rectifier; wave trap; tone control; pentode output tube.)

The following table gives operating voltages to this receiver:

Tube	Plate	S.-G.	C.-G.	Su.-G.	Cathode
V1	45	110	0	5	5
V2*	117	52	0	—	2
V3	120	110	0	3	3
V4	30	—	0	—	1
V5	112	120	0	—	14
V6	115**	—	—	—	135
V7	114**	—	—	—	117

*Grid 1 of V2 runs at -4 V. and Grid 2 at 90 V. **A.C.

All measured from respective elements to ground. The line voltage is 120. The table voltage will be slightly lower when the receiver is connected to a D.C. source. The

set should be tuned to 1,000 kc. with no signal input.

Notice that one 25Z5 is used to supply high voltage to the receiver, while the other is used to supply the speaker.

The locations of all trimmers are shown in the small detail drawing at the right. The numbers correspond with those of the trimmer condensers on the circuit drawing.

An antenna trap circuit keeps out code and other radio interference, which otherwise might be reproduced through the I.F. amplifier circuits. Note use of pentode output, V5! The receiver draws 65 W. from the line, and the power output is about 1.5 W. Voltage across pilot lamps is 27 V. (S.-C. previously avoided use of pentodes.)

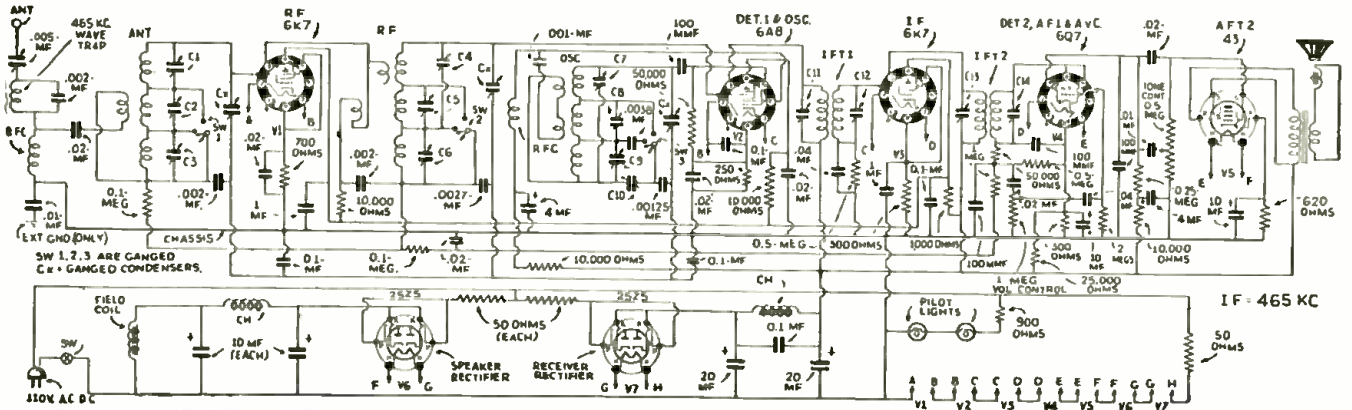
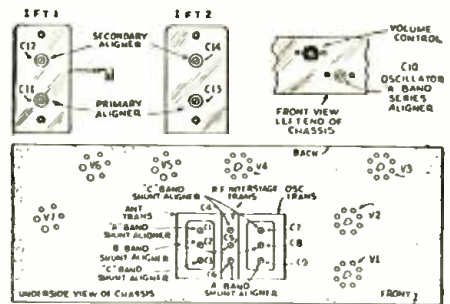

TECHNICIANS' DATA SERVICE

JOSEPH CALCATERRA

DIRECTOR

A special arrangement between RADIO-CRAFT magazine and the publishers of this literature, which permits bulk mailings to interested RADIO-CRAFT readers, eliminates the trouble and expense of writing to each individual organization represented in this department.

2. HAMMARLUND 1936 CATALOG. Contains 12 pages of specifications, illustrations and prices on the new line of Hammarlund variable, mid-geet, hand-spread and adjustable condensers; trimming and padding condensers; R.F. and I.F. transformers, coils and coil forms; sockets, shields, chokes and miscellaneous parts of ultra-short-wave, short-wave and broadcast operation.

3. HOW TO GET A HAMMARLUND 1936 SHORT-WAVE MANUAL. A circular containing a list of contents and description of the new 16-page Hammarlund Short-Wave Manual, which contains construction details, wiring diagrams, and list of parts of 12 of the most popular short-wave receivers of the year.

4. THE "COMET PRO" SHORT-WAVE SUPER-HETERODYNES. Describes the outstanding features of the standard and crystal-type Hammarlund "Comet Pro" short-wave superheterodynes designed to meet the exacting demands of professional operators and advanced amateurs for a 15 to 250 meter code and phone receiver, but which can be adapted by anyone for laboratory, newspaper, police, airport and steamship use.

5. ELECTRAD 1936 VOLUME CONTROL AND RESISTOR CATALOG. Contains 12 pages of data on Electrad standard and replacement volume controls. Truvolt adjustable resistors, vitreous wire-wound fixed and adjustable resistors and voltage dividers, precision wire-wound non inductive resistors, center-tapped filament resistors, high-quality attenuators, power (50- and 150-watt) rheostats and other Electrad resistor specialties.

57. RIBBON MICROPHONES AND HOW TO USE THEM. Describes the principles and operating characteristics of the Amperite velocity microphones. Also gives a diagram of an excellent humless A.C. and battery-operated preamplifier.

59. THE EVOLUTION OF TUBE TESTING. This interesting booklet, published by the Supreme Instruments Corp., traces the development of tube testing equipment and gives a complete technical description, with wiring diagram and discussion of the technical points involved in the design and use of the Model 89 Supreme Radio Tester for testing all tubes, and also paper and electrolytic capacitors.

62. SPRAYBERRY VOLTAGE TABLES. A folder and sample pages giving details of a new 300-page book, containing 1,500 "Voltage Tables" covering receivers manufactured from 1927 to date. published by Frank L. Sprayberry to simplify radio servicing.

64. SUPREME No. 385 AUTOMATIC TESTER. A technical bulletin giving details, circuits and features covering this new Supreme development designed to simplify radio servicing. In addition to the popular features of Supreme analyzers and tube testers it contains many direct-reading features which eliminate guess-work or necessity of referring to charts or tables.

65. NEW 1936 LINE OF SUPREME TESTING INSTRUMENTS. This 16-page catalog gives complete information on the entire Supreme line of testing instruments, including the Model 385 Automatic Tube Tester and Analyzer, the Model 339 DeLuxe and Standard Analyzers, and other standard Tube Testers, Set and P.A. Analyzers and Signal Generators. Complete details of the Supreme Easy Payment Plan for purchasing testing equipment on the installment plan are given.

67. PRACTICAL MECHANICS OF RADIO SERVICE. Information, including cost, features and outline of lessons of the Frank L. Sprayberry course in Radio Servicing, and list of Sprayberry Data Sheets for modernizing old radio equipment.

73. HOW TO ELIMINATE RADIO INTERFERENCE. A handy folder which gives very complete information on how to determine and locate the sources of radio noise by means of the Sprague Interference Analyzer. A description of the analyzer and method of using it is included, together with data on how to eliminate interference of various kinds once the source is located.

74. SPRAGUE 1936 ELECTROLYTIC AND PAPER CONDENSER CATALOG. Gives specifications, with list and net prices on a complete line of wet and dry electrolytic, and paper condensers made by the Sprague Products Co. for radio Service Men, set builders, experimenters and engineers. Information on the Sprague Capacity Indicator, for making capacity tests on condensers and in servicing receivers, is included.

75. SPRAGUE TEL-U-HOW CONDENSER GUIDE. A valuable chart, compiled by the Sprague Products Co. which tells the proper types, capacity values and voltages of condensers required in the various circuits of radio receivers and amplifiers, and how to locate radio troubles due to defective condensers. Includes data on condenser calculations.

76. FACTS YOU SHOULD KNOW ABOUT CONDENSERS. A folder, prepared by the Sprague Products Co., which explains the importance of various characteristics of condensers, such as power-factor, leakage, capacity and voltage in determining the efficiency or suitability of a given condenser to provide maximum filtering and safety in operation.

QUALITY AT A
POPULAR PRICE—
THE COMPLETE
WESTON SHOP
AND FIELD TESTER
\$45.00 NET IN U.S.A.



The
**WESTON
CHECKMASTER**

Tests all tubes . . . spare sockets . . . Neon short check . . . cathode leakage test . . . individual tests on diodes . . . point-to-point voltage ranges . . . resistance-continuity features . . . Neon high resistance leakage test . . . positive line voltage control . . . the famous WESTON 301 Meter . . . striking design and finish. Send coupon for full data on Model 771, and the new WESTON Tube Base Chart.

Weston Electrical Instrument Corporation
599 Frelinghuysen Ave., Newark, N. J.
Please send bulletin on the WESTON Model 771 Checkmaster. Also a copy of the new WESTON Tube Base Chart.

Name _____
Address _____
City _____ State _____

Radio-Craft Technicians' Data Service
99 Hudson Street,
New York City, N. Y. RC-636

Please send to me, without charge or obligation, the catalog, booklets, etc. the numbers of which I have circled below.

2	3	4	5	57	59	62
64	65	67	73	74	75	76

My radio connection is checked below:

- Service Man operating own business.
- Service Man for manufacturer.
- Service Man for jobber.
- Service Man for dealer.
- Service Man for servicing company.
- Dealer.
- Jobber.
- Experimenter.
- Professional Set Builder.
- Amateur Set Builder.
- Short Wave Work.
- Licensed Amateur.
- Station Operator.
- Radio Engineer.
- Laboratory Technician.
- Public Address Worker.
- Manufacturer's Executive.
- Student.
-

I am a:

Subscriber Newsstand reader
I buy approximately of radio material a month. (Please answer without exaggeration or not at all.)

Name

Address

City State.....
(Please print name and address)

Avoid delay. The catalogs and booklets listed are now in stock and will be sent promptly as long as the supply lasts. Please use this coupon in ordering. The use of a letter causes confusion and delay.

IF

You are a Service Man, you will surely want to ask your newsdealer, today, to reserve for you a copy of the forthcoming July issue of *Radio-Craft*. This *Annual Service Number* carries construction articles on an oscilloscope, a magic-eye V.T. voltmeter, a new *Radio-Craft* set analyzer, and many other important articles including latest information on the new Alnico-magnet dynamic speakers.

Please Say That You Saw It in RADIO-CRAFT

ANNOUNCING . . . THE PEERLESS 3-TUBE ALL-PURPOSE AMPLIFIER



HERE it is—the Peerless All-Purpose Amplifier—the Amplifier buy of the year. It has 3½ watts output, with 5 watts peak—75-db. gain. The field supply drives any 2,500-ohm speaker—high-impedance input. Employs three tubes—57, 2A5 and 80. Peerless All-Purpose 3-tube Amplifier, less tubes, microphone and speaker \$3.20
 Speaker, including matching transformer 3.15
 Microphone—double-button, high-quality type 3.75
 Kit of three (3) matched tubes 1.48

Write for descriptive literature on other P. A. equipment and accessories.
 Midget Radio Sets \$5.50 up
 Write for descriptive literature
 1 Watt carbon resistors, per 100 \$2.85
 8 mid 550 volt peak electrolytics, dozen 2.75
 Esico soldering iron65
 We distribute all nationally advertised line of replacement parts such as Sprague, Mallory, IRC, Electrad, Yaxley, etc. National Union, Raytheon, RCA.

UNCLE DAVE'S RADIO SHACK, 356 Broadway, Albany, N.Y.
 Cable Address "UNCLEDAVE". Prices net F.O.B. ALBANY. Include 20% deposit with c.o.d. orders.

SHORT CUTS IN RADIO

(Continued from page 716)

receiver under test, the fuse in the box will blow instead of the one in the customer's fuse panel (perhaps in an inaccessible spot!). The fuses should not be higher than 5 A. rating.
 EUGENE KINGREY

HONORABLE MENTION

EMERGENCY SOLDERING. When working on an auto receiver, it is sometimes very unhandy to use an electric soldering iron. In such cases I use a piece of lead from a pencil, and a pair of test leads, with clips on each end. A clip of one lead is fastened to the chassis of car or radio, and the other clip to the work to be soldered, as shown in Fig. 7. The second connection is fastened respectively to the ammeter and (the opposite end) to the pencil lead, which may be about an inch long. Simply bring the pencil lead in contact with the work and apply solder.
 GEORGE J. COPPOCK

HONORABLE MENTION

MAKING THE CAR-RADIO SET QUICKLY DETACHABLE. Car receivers of the type which bolt to the dash may be made quickly removable. This is done by means of keyhole-shaped openings cut in the dash. The head of the mounting bolts should pass through the large part of the hole, while only the shank passes through the small part. To remove the receiver it is only necessary to loosen the bolts and lift the case slightly when the bolt heads, or nuts, will pass through. This system may be used on either single- or multiple-bolt mountings. See Fig. 8.
 E. T. GUNDERSON, JR.

HONORABLE MENTION

HANDY CLIP. This device, which is fully explained in Fig. 9, is very handy and saves a lot of time. The new clip unit slips onto the end of the test-lead point, but may be removed at will.
 NEIL HOLLINGER

HONORABLE MENTION

INEXPENSIVE STAND-OFF INSULATOR. A post from a discarded Ford Model T magneto, mounted as shown in Fig. 10, serves as an excellent stand-off insulator. The post must be cleaned thoroughly; the spring is then removed, and the bottom sawed off.
 BARTON WOOD

The OUTSTANDING SIGNAL GENERATOR



THE highest requirements of precision and convenience for all-around work are met in the Model 339 Signal Generator, that works on a.c. or d.c. of 90-125 volts, to measure frequencies from 54 to 17,000 kc. and fine Hz channels. It also serves for determining the frequency of a station that is being received.
 Coincidence of generated frequency and scale reading is 1 per cent. This high order of accuracy obtains in no other instrument selling at less than twice the cost of the 339.
 Many, no doubt, have been somewhat confused by the numerous types of signal generators, but will note that the best of them cover wide ranges on fundamentals, have an attenuator, and permit of pressure or absence of modulation. Also they have a vernier dial and are direct-reading in frequencies, accurate to at least 3 per cent. The 339 has all these advantages, besides affording wavelength determinations as well, and operation on 90-125 volts a.c. (any commercial frequency) or d.c. And the accuracy is three times as great. Moreover, the 339 is well built, for lifetime use, and covers all waves fundamentally, besides permitting measurements of frequencies up to 100 mc (down to 3 meters) by resort to a slight calculation method, applying a simplified harmonic system to the 5,400 to 17,000 kc. fundamental band.
 The 339 has a 616 rf. oscillator, a 37 rectifier tube, so that d.c. is used on the plate, while modulation is provided by a neon tube relaxation oscillator at a frequency of about 1,000 cycles.

- ◆ MODEL 339, A 6-band Signal Generator, 54 to 17,000 kc., all on fundamentals, switch operated, direct reading in frequency and wavelength; universal operation. Modulation on-off switch and attenuation. Electron coupled. Wired, tested, calibrated, with three tubes (616, 37 and neon). Ship- ping weight, 8 lbs. \$16.00



RADIO CONSTRUCTORS LABORATORIES
 136 LIBERTY STREET Dept. RC NEW YORK, N. Y.
 All Shipments in 24 Hours After Receipt of Order

HOME RECEPTION in the AUTOMOBILE with The "LONG-RANGE TWINS" Sealed in Leak-Proof Rubber

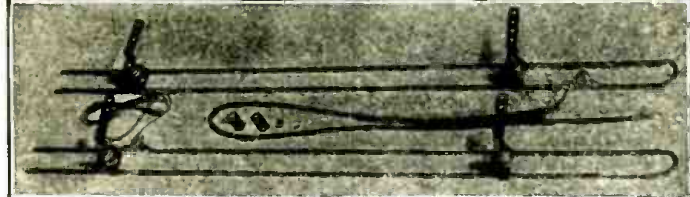

SIX NEW FEATURES ELIMINATE SIGNAL LEAK IN AUTO AERIALS
 93% Signal Strength Efficiency according to Certified Laboratory Tests
 JUST OFF THE PRESS-- Free Copies Available-- 'AERIAL NEWS' All About NEWEST DEVELOPMENTS In Automotive Antenna. Write for yours today.

WARD PRODUCTS CORPORATION 2135 Superior Ave. CLEVELAND, O.

The "SUPER-PRO" ADVANCED Amateur-Professional Receiver

THE finest receiver ever to bear the Hammarlund name. Out-performs all preceding standards of sensitivity, selectivity and tone. Brimfull of exclusive features.
 Write Dept. RC-6 for Complete Details
HANMARLUND MANUFACTURING CO.,
 424-438 W. 33rd St., New York.



NEW LOW PRICE on AMPERITE CURRENT AND VOLTAGE REGULATORS

Amperite replacements for AC-DC sets now LIST \$1.25. Amperite 3-40 can replace AC-DC set regulators 50x3, 300, and 5B. Also new low price on replacements for 2-Volt Battery Sets, list \$1.60
 Write for CHART CV
AMPERITE Co. 561 BROADWAY NEW YORK

HONORABLE MENTION

AN ADJUSTABLE-CAPACITY TRIMMER. Most experimenters find that the usual type of trimmer is not efficient over the whole short-wave band. A trimmer used for bandspread which is satisfactory on the high-frequency band, will have too low a capacity to be of any use on the lowest band, and vice versa. An improved trimmer is shown in Fig. 11, which can be used efficiently over the whole range of the receiver. The shaft pulls in and out for wide variations of capacity, such as are needed when changing from one band to another, while the usual rotary motion is used for actual bandspread action. Springs A keeps the shaft from sliding too easily.
 Wm. G. WHEAT

HONORABLE MENTION

PRONG CLEANER. I have serviced sets with the fault of "cutting out" when playing, then suddenly coming on again. The trouble has often been found to be caused by dirty socket prongs. A good cleaner may be made, as seen in Fig. 12, by dipping a ¼-in. dia. wooden dowel several inches into a glue pot, then rolling the dowel in fine sand (emery dust is conductive and should not be used). Allow this to dry overnight, and you have a fine socket prong cleaner.
 O. L. HALSTEAD

HONORABLE MENTION

WIRE SHIELDING. Old (or new) auto copper oil line, when well cleaned inside and out makes fine shielding, if used with well-insulated wire. It can be obtained in many sizes and is easy to solder. See Fig. 13.
 ALFRED J. MURPHY

Please Say That You Saw It in RADIO-CRAFT

PUBLIC ADDRESS—A MISNOMER

(Continued from page 717)

tion. The amplifier is equipped with 2 speaker plugs inasmuch as 75 per cent of these units are sold with 2 speakers. A 500-ohm output terminal is provided, which connection is paralleled with the 2 speaker sockets. To eliminate the necessity of matching transformers when additional speakers or headsets are used, an output impedance switch is included as standard equipment. Standard loudspeakers are equipped with 500-ohm transformers; the instructions to the user are simple. For 1 speaker set the speaker control switch at No. 1—500 ohms; for 2 speakers, No. 2—250 ohms; for 3 or 4 speakers, No. 3—125 ohms; for 5 or 6 speakers, No. 4—84 ohms; and taps No. 5 and No. 6 supply 35 ohms—15 ohms. With the latter taps it is possible to use 1 or 2 electrodynamic horn units for outside work or for large inside auditoriums. To complete the flexibility, permanent-magnet dynamic speakers are used and with the 500-ohm line the user may run speaker lines any reasonable distance without affecting the quality.

Disregarding the auditorium, hotel, school, hospital and other installations made by an organization in this field, let us take the same amplifier described above and from the sales records, see how far we digress from public address work by simply changing the accessories used with this standard amplifier.

(1) **Systems for Entertainment.** The first step away from systems used for public speaking are those used for the reproduction of vocal and chorus work. The equipment remains practically the same as the system for public speaking (a microphone, amplifier and 2 loudspeakers) but quality has to be improved materially over a wider and flatter response.

(2) **Restaurant Order Unit.** Crystal microphone, standard amplifier, from 1 to 4 "P.M." (permanent-magnet) dynamic reproducers in parallel or on a simple speaker control switch arrangement. In this instance the microphone is placed on the counter near the amplifier with loudspeakers in basement kitchens with an average of from 2 to 4 reproducer positions.

(3) **"Talk-Back" Systems.** Crystal microphone, standard amplifier, and from 2 to 4 loudspeakers; and headset for return message. Such a system is used where an answer must be given such as in laundries, automobile repair shops, fur storage vaults, etc.; another switch is installed in the amplifier for the purpose of reversing the input and output circuit. The order is given through the microphone and received from the loudspeaker; after which the key is pressed—the answer, then given into the loudspeaker, is received in the headset. The loudspeaker becomes a fairly efficient low-level microphone and the message is received distinctly in the headset, even though the repair or Service Man is from 15 to 25 ft. away from the loudspeaker!

(4) **Fox Farms.** To prevent destruction of young fur-bearing animals it is necessary to maintain a constant watch. Several crystal microphones are installed in nest houses and the watchman listens-in from a central control point. It is possible to parallel 4 or 5 crystal diaphragm microphones, the only sacrifice being that of the input level. When more than 2 microphones are paralleled a small portable preamplifier is inserted in the circuit to compensate for the loss of paralleling more than 2 microphones.

(5) **Mill Work.** Wire processing machines, strip-steel mills, bottling works and other continuous processings have been relying upon signal systems to indicate trouble in continuous processing machinery. While flasher or buzzer signals clearly indicate trouble between the operators on the input and output of such machines they offer no means of describing the trouble. With 3 or 4 crystal microphones, standard amplifier, and loudspeaker, it is possible to describe the trouble and in many instances prevent complete shut-down or damage. The last installation made of this type was used on a machine processing numerous coils of strip-metal at the same time. Instead of complete shut-down it is now possible to stop the one coil in which the trouble arises.

(6) **Group Hearing Aid.** Crystal microphone, standard amplifier and from 20 to 50 headsets used in theatres, churches, hard-of-hearing schools, auditoriums and hard-of-hearing club rooms.

(7) **Confessional Installation.** Two crystal microphones, standard amplifier and 2 headsets with simple switching arrangement. A system used to maintain a low level of speech for both the hard-of-hearing as well as those whose hearing is normal.

(8) **Funeral Parlors.** Electric single-play or automatic phono, turntable, standard amplifier and loudspeakers to reproduce organ recordings. This is one of the largest and steadiest outlets for small equipment. Although this set-up costs only a few hundred dollars, it replaces the cost of a pipe organ and organist; and recording companies now supply large libraries of recordings for funeral parlor services. Only about 5 per cent of such installations include a microphone.

(9) **Noise Measuring Equipment.** Crystal microphone, standard amplifier and meter. The meter is graduated to indicate what is considered a normal noise level with graduations to show high or low conditions. These are used to measure street noises, noise level in air-conditioning machinery, or wherever a standard of noise level is to be determined and improved to more favorable conditions.

(10) **Crime Prevention.** Standard amplifier (also supplied for battery operation) and headset. A standard crystal microphone in a special case is supplied with this system. Other forms of pick-up supplied with the system lead us to another classification of equipment which is another stage away from "Public Address" work.

These accessories include a wire-tapping device, an induction coil for picking up telephone conversation without tapping the lines and a "contact"-type crystal microphone. In this microphone the driving pin contacts both the crystal unit and a solid object which vibrates to sound. This microphone can be applied to the outside of a door or wall, making it possible to amplify conversation without gaining admittance to a room.

(11) **Heart-Beat Recording.** The "contact" microphone mentioned above is leading the industry into an entirely new field. (The contact microphone is a unit which picks up sound vibrations in solids rather than in the air.) Doctors are able to accurately diagnose heart trouble, and sounds originating in the body are now detected which were not noticeable through the ordinary stethoscope. A contact microphone is affixed to the body and sounds are detected either with the headset or loudspeaker.

(12) **Detecting Water Leaks.** A contact microphone, standard amplifier and headset. By placing the contact microphone on the ground or against a short post driven into the ground, water main leaks can be clearly detected. By placing this at various points, the varying intensity of sound will direct the operator to a point directly over the leak.

(13) **Watch Repair.** The watch manufacture and repair industry is consuming a large amount of this equipment. The watch is placed in contact with a sensitive contact microphone, the resulting sounds being similar to the sounds emitted from a small-size machine shop.

(14) **Musical Instruments.** The two uses mentioned above demand a highly-sensitive contact microphone but high fidelity is not of extreme importance. In amplifying the sounds of a musical instrument a high-fidelity sound cell is securely mounted in a small case and the whole assembly vibrates through actual contact. Such devices are used with the standard amplifier and loudspeaker. They are attached to the body of a guitar, violin, banjo, etc., and new and unusual results are being obtained in thus amplifying faithfully and at "loudspeaker" volume, the sounds of musical instruments.

Numerous other applications can be sighted and the ones enumerated above are undoubtedly of interest to those who have not considered the possibilities in this field. All the ideas mentioned are in actual use, and are improving the accuracy and efficiency in each instance. This seems to offer conclusive evidence that a term other than "Public Address" would more aptly describe this field of work.

Our Information Bureau will gladly supply manufacturers' names and addresses of any items mentioned in RADIO-CRAFT. Please enclose stamped return envelope.

Please Say That You Saw It in RADIO-CRAFT

EVERY SERVICEMAN

OWES IT TO HIMSELF

TO READ
MY NEW

FREE
BOOKLET



Throughout the world you'll find Sprayberry Trained Men

Learn exactly what Sprayberry Advanced Service Training can mean to you in terms of a better, more profitable service business!

Now finer, more complete, more helpful than ever. New lessons—new ideas—new technical data—new business building plans and methods. In short, no matter what help you need in winning a better job or service business you will find it covered here. Sprayberry Advanced Training has spelled the difference between failure and Success to many. Let it help you, too!

There's no room for "screw driver mechanics" in these competitive days. You've got to be able to do better work on even the toughest jobs—and you've got to know how to advertise, merchandise and collect for the work you've done. Sprayberry Training is COMPLETE.

Remember! You Can't "Wish" Yourself Into a GOOD-PAYING SERVICE JOB!

Sprayberry Training helps you in every conceivable way. Sixteen new lessons have just been added making a total of 48 in all. Just the help you need—at a price so low you simply can't afford to miss it. Get the facts.

**16
NEW
LESSONS**

FOR THOSE WITH NO PREVIOUS RADIO EXPERIENCE, we also offer a complete general Training course—one which actually sets up the student with complete, standard equipment READY FOR BUSINESS upon completion. Ask for our General Catalog.

SPRAYBERRY ACADEMY OF RADIO

F. L. SPRAYBERRY, President
2545 University Pl., N. W., Washington, D. C.

Please send, without obligation on my part, your NEW Booklet "MY FUTURE IN RADIO" describing your Advanced Service Training.

Name

Address

..... RC 6-36
(For convenience, paste this coupon on penny postcard—AND MAIL TODAY.)

HOW TO MAKE A 2 1/2 TO 555 METER DX SET

(Continued from page 717)



"the 'Circuits' go round & round"

Service any set with a song . . . no matter how involved the circuit . . . that is . . . if you've been tipped off to use CENTRALAB replacement parts wherever Volume Controls and Fixed Resistors are indicated. Get off the "merry go round" of service headaches. Ask for and insist on CENTRALAB.



Centralab

MILWAUKEE WIS.
RADIOHMS SUPPRESSORS
FIXED RESISTORS
WAVE CHANGE SWITCHES

NEW "CHANGEABLE FIELD" REPLACEMENT SPEAKERS

by OXFORD

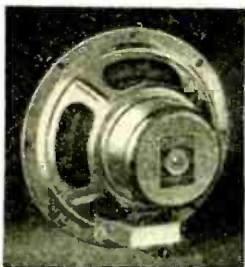

Today's outstanding development in Electro-Dynamic Replacement Speakers! Permits quick, easy change of field coil to give you the proper combination of transformer and field for the "job" when you need it. Universal transformer matches any tube. Voice coil remains centered! Available in 6", 8" and 11" models.

Ask your Jobber—or Write TODAY for Bulletin 361C.
OXFORD-TARTAK
RADIO CORPORATION
915 W. VAN BUREN ST. CHICAGO, U.S.A.

This SCREWDRIVER Actually GOES AROUND a CORNER!

New, modern FLEXIBLE-SHAFT SCREWDRIVER permits access to screws in awkward places—actually goes around a corner. Shaft of laminated steel wires; nickel-plated fittings; tempered steel blades; fluted, hard-wooden handle. Length overall 18" from ferrule to tip 4 1/2". Hundreds of uses for this FLEXIBLE-SHAFT SCREWDRIVER. Price \$1.00 POSTPAID. ORDER TODAY!

COMMONWEALTH PRODUCTS CO.
401 Broadway
New York, N. Y.

an electron-coupled regenerative circuit, utilizing an R.F. buffer tube (thus eliminating plug-in coils on all the usual short-wave bands).

(2) On the ultra-high frequencies—from 15 meters down to 2 1/2 meters—simple band switching is not efficient and straight regeneration becomes too critical. Accordingly super-regeneration, with its remarkable sensitivity and tremendous amplification, is utilized with small air-core plug-in coils, as illustrated.

DUAL REGENERATION CONTROL

Going back to the regenerative section of the circuit (above 15 meters) it is, or should be, well known that "a regenerative receiver is no better than its regeneration control." For far-distance work perfect control is not only of great importance, but is an absolute necessity! It is in that last sixty-fourth of an inch on the regeneration control knob before circuit oscillation occurs that most of the remarkable R.F. amplification, of which this circuit is capable, takes place.

In designing the R-S-R every effort was made to obtain the smoothest and most stable regenerative control possible. To this end two regeneration controls are provided. The 2,000-ohm potentiometer in the detector cathode circuit is the main control, and limits the R.F. feedback to the grid circuit; while the 50,000-ohm potentiometer in the detector plate circuit changes the tube impedance by varying the screen-grid and plate voltages, and gives a very gradual vernier regeneration adjustment.

In fact it takes that last sixty-fourth of an inch on the main control and spreads it out over about 180 degrees! What this means in terms of actual reception of weak distant stations is a revelation to anyone who is not familiar with the possibilities which exist in this circuit.

THE BUFFER STAGE

As shown in the diagram a 6K7 variable-mu tube is used as an untuned buffer, or R.F. amplifier, before the regenerative detector. The main purpose of this tube is to stabilize the detector and allow its full regenerative gain to be utilized on all frequencies. It does more than this, however, as it shows a substantial R.F. gain, particularly on the short-wave stations where the coupling has been designed to be most effective.

The results obtained from an untuned buffer stage of this type depend on several factors such as the mechanical layout, wiring, tube used, etc. But the most important factor of all is the coupling arrangement between the buffer tube and the regenerative detector. In the first place this should be variable, to compensate for various tubes, antennas, etc. This also allows the selectivity of the receiver to be broadened or sharpened as desired. This adjustment is accomplished in the R-S-R by a semi-variable 100 mmf. mica condenser shown in the diagram between the plate of the buffer tube and one switch arm of the inductance switch.

The remainder of the R.F. coupling consists of a specially-wound R.F. choke of rather low

inductance value. For some reason it seems to be an accepted custom to use a 2.5 millihenry choke here; perhaps because they can be easily purchased. Such a value gives splendid R.F. gain at the standard broadcast frequencies—so good in fact that the set could not be used on an average antenna without hearing most of the local stations all over the broadcast band and often on the short-wave bands as well.

However, as the R-S-R was designed primarily for short-wave reception a value was chosen for this coupling choke which would place the maximum gain on the higher frequencies and allow only a reasonable gain, with good selectivity, on the standard broadcast band. (About 175 to 200 turns of No. 34 enameled wire, close-wound on a 3/8-in. bakelite rod, is about right for average conditions. The other two R.F. chokes shown in the diagram are each 40 turns of No. 26 enameled wire on the same diameter rod.)

SUPER-REGENERATION

A simplified self-quenching super-regenerative circuit is used on the ultra-high frequencies. It is both sensitive and stable and requires no special adjusting as long as the specified values are used. This tuning assembly is separate from everything else in the circuit and is mounted as a complete unit on an insulated sub-panel set into the sub-base. Its small variable tuning condenser is controlled by the dial at the bottom-center of the front panel. This affords entirely single control tuning so that stations can be accurately logged.

The small self-supporting coils (astride C4) used below 15 meters plug into two pin-jacks, 1 3/4 ins. apart, on the insulated sub-panel; the connection ends of these pin-jacks come through the panel just adjacent to the variable condenser terminals. A glass, type 76 tube is used as super-regenerator due to its low inter-electrode capacity and favorable characteristics for this work (as compared to those metal equivalents that the author has so far tried—Editor). This tube is mounted in back of the U.H.F. (ultra-high frequency) tuning assembly. Such a compact arrangement allows very short leads and high efficiency at these high frequencies.

When using super-regeneration, hiss control is obtained with the same 50,000-ohm potentiometer (located at lower-right of the front panel) which is used for vernier regeneration control on the longer wavelengths. This allows for the most sensitive "super" adjustment, minimizes radiation and enables the hiss level to be reduced to the vanishing point.

BUILT-IN POWER SUPPLY

The R-S-R can be used on either an A.C. or D.C. 110 V. power line. It does not, however, suffer from the usual line hum, even on headphones, so characteristic of many "universal-current" type receivers; this is accomplished by the use of adequate filtering and bypassing (note the 60 mf. filter condenser block).

Either metal or metal-glass tubes should be used with the exception of the super-regenerative

The circuit of the complete set including values of parts.

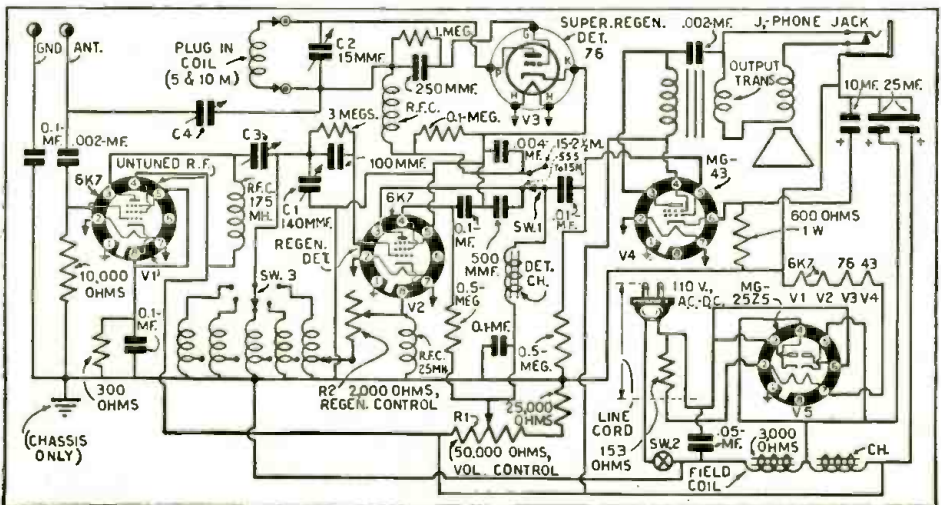

Please Say That You Saw It in RADIO-CRAFT

\$1800
For this TUBE TESTER



MODEL 430
RELIABILITY AT LOW COST

- ★ Tests all type tubes—Metal, Glass, Class-
- ★ Metal.
- ★ Line voltage adjustment.
- ★ Leakage and Short Test.
- ★ Triplet Direct Reading Instrument (GOOD-BAD Scale).

Readrite
TESTERS AND METERS
MAIL COUPON NOW

Readrite Meter Works
 616 College St., Burton, Ohio
 Without obligation please send me more information on Model 430 Model 431
 Send complete catalogue.

Name
 Address
 City State

This article covers only the A.F. amplifier re-
 quirements for high fidelity and does not treat
 of accessory requirements such as pickups and
 reproducing devices. If we examine the above
 design requirements in sequence, the corre-
 sponding controlling factors can readily be de-
 termined. Frequency discrimination in A.F. am-
 plification is almost entirely controlled by the
 range. Commercial production of such units
 requires specialized production equipment and
 transformers having extremely wide frequency
 in this field have resulted in the development of
 A.F. transformers used. Many years of research
 measurements under the actual conditions of
 use.

Harmonic content is primarily a function of
 the tubes used and their operation. When prop-
 erly used a vacuum tube is practically a linear
 device (at the point of linearly deviation, har-
 monics are introduced). Consequently, it is essen-
 tial that the power output be normally kept
 below the point of maximum allowable deviation.
 This in turn, makes necessary the use of proper
 measurements, makes necessary the use of proper
 vacuum tubes correctly operated so that not over
 5 per cent harmonic distortion is effected at the
 highest power output normally required. In addi-
 tion to this, care must be taken in the design
 of A.F. transformers, particularly those opera-
 ting at high levels, so that the transformer will
 operate over an essentially linear portion of the
 core material magnetization curve. It is necessary
 that the noise level be at least 70 db. below maxi-
 mum output. Modern quality resistors and con-
 densers have practically a negligible noise level,
 narrowing noise difficulties almost entirely to
 A.C. hum. Precautions for reduction of A.C. hum
 are described in Table I in conjunction with
 actual application to an A.F. amplifier.
 Analyzing the above, we can state the 5
 important factors for a high-fidelity amplifier as:

- TABLE I**
1. Uniform frequency response.
 2. High efficiency.
 3. Low harmonic distortion and phase shift.
 4. High power output.
 5. Low hum level.

By the use of high-quality A.F. transformers,
 practically all frequency discrimination has been
 eliminated from this amplifier. An overall fre-
 quency run on a finished unit indicated a varia-
 tion of less than 2 db. from 30 to 16,000 cycles.
 High efficiency is obtained in the amplifier
 through the use of only 3 stages, transformer-
 coupled. With the power stages operated in class
 A prime. The overall gain obtained is over 80 db.
 The first and second stages use type 6C6 tubes,
 triode connected. These tubes are excellent vol-
 tage amplifiers, having a mu of approximately
 20 and a plate resistance of approximately
 12,000 ohms. Checks on the filament hum and the
 microphone action of these tubes show them to
 be excellent.

The second stage is transformer-coupled to a
 pair of 6A3 tubes, operated fully A prime. The
 tubes, in common with some of the new 2A3
 tubes, consists of 2 triodes connected in parallel
 in one envelope. (This type of tube construction
 is an appreciable improvement over the older
 types of 2A3 tubes, as secondary emission is
 eliminated and higher power outputs are avail-
 able.) Operating these tubes in their overbiased
 condition, the plate current varies over a very
 wide range from zero to maximum signal. The
 tubes are normally adjusted for about 40 ma.
 Operating on peak power
 output, this plate current may rise as high as
 120 ma. per tube. In a self-biased circuit, the
 bias voltage is developed across the cathode re-
 sistor which carries the plate current. Naturally
 a wide variation in plate current will cause a
 fluctuating bias voltage and a consequent high
 harmonic content.

Using fixed bias, however, this effect is en-
 tirely eliminated. It is important, though, that
 both plate and bias supply have good regulation.
 A very common method of obtaining a form of
 fixed bias is a voltage-divider system. Upon
 close examination, however, it is found that the
 portion of the divider in the grid circuit still
 carries the fluctuating plate current of the out-
 put tubes, and consequently distortion will occur.

Please Say That You Saw It in RADIO-CRAFT

The system of fixed-bias supply incorporated
 in this amplifier, on the other hand, is one which
 has now been proven over a number of years.
 A 2 1/2-V. filament winding on the power trans-
 former supplies current to the filament of a
 type 45 tube. The center-tap of this filament
 winding is connected to a low-voltage tap on
 the transformer high-voltage winding. The
 resultant circuit is a half-wave rectifier function-
 ing in an opposite direction to the normal plate
 supply. That is, the output voltage of this recti-
 fier is negative with respect to ground.
 A filter is placed in this circuit to eliminate
 hum and it is then fed into a potentiometer ar-
 rangement whereby the bias voltage can be in-
 dividually adjusted for the two output tubes.
 It is highly desirable in class A prime circuits
 that the output tube plate currents be identical.
 Where it is not convenient to check the levels
 a millimeter, adjust the potentiometers for
 minimum output hum.
 If we summarize the actual important factors
 which set apart this amplifier as one of the
 highest-fidelity units ever produced, they may be
 noted as follows:

- TABLE II**
- High gain: 80 db., suitable for most P.A. and home applications.
 - Low distortion: less than 5 per cent at all levels below normal maximum output.
 - True and ideal class A prime operation in output stage.
 - High-power output: 30 W., undistorted, 50 W. peak.
 - Plate and bias supply having good regulation.
 - Extremely low hum level.
 - Unusual simplicity of construction.
 - Inexpensive tubes and economical operation.
 - And last but not least, an ideal fidelity characteristic covering the entire A.F. range, 30 to 16,000 cycles.

(Those requisites mentioned in Table II but not discussed in this article have been met, in the manner here shown by diagram and photograph; the general procedure has been given in past issues of *Radio-Craft*—Editor)

The amplifier is so constructed that it is suitable for rack mounting. A number of these units, with but slight modification, have already been tried and proven by many broadcast and recording organizations.

This amplifier system will faithfully transmit all frequencies through the entire audio range at level from the barely audible pianissimo effect to the resonating orchestral clashes of 10,000,000 times greater power without any undistorting noise, hum or distortion. As such, it is ideal for any sound amplifier application having high-fidelity requirements.

This article has been prepared from data supplied by courtesy of United Transformer Corp.

The circuit of this equipment is quite simple, shielded and has a noise filter built-in.

The converter is so small that it may be mounted in almost any corner, and is attached to the set by a shielded lead. The unit is completely set by a shielded lead. The unit is completely set by a shielded lead. The unit is completely set by a shielded lead.

verter is in the circuit.

illuminated dial gives indication when the con-
 on, but also shifts the antenna lead to the proper
 needed. The switch not only turns the converter
 in the converter transfers reception from long
 vernier dial which gives ease of tuning. A switch
 condenser is also built into the case with a
 only 1 tube, a 6A7, being used. A 2-gang tuning
 The circuit of this equipment is quite simple,
 shielded and has a noise filter built-in.

NEW DEVICES FOR THE CAR-RADIO OWNER

(Continued from page 721)

49-meter short-wave broadcast bands. The latter
 will probably be the most widely used by the
 layman, since in many localities, the use of a
 short-wave receiver in a car is unlawful, if it
 is capable of being tuned to the police bands.
 The converter is so small that it may be mounted
 in almost any corner, and is attached to the car
 set by a shielded lead. The unit is completely
 shielded and has a noise filter built-in.

MAIL COUPON NOW

Readrite Meter Works
 616 College St., Burton, Ohio
 Without obligation please send me more information on Model 430 Model 431
 Send complete catalogue.

Name
 Address
 City State

TRADE IN CHASSES
ALL ELECTRIC—7 & 8 tubes.
 Complete with tubes and speakers.
 Majestic, Philco, RCA, etc. **\$5.95**
 Limited number available
 Write for our free parts catalog.
HERALD RADIO SALES
 7 E. Congress St. Chicago, Ill.

Service Men
 New Handy Pocket Tool Case keeps your tools together in a convenient place. Fits in your hip pocket or fanny on your belt. Saves weight and labor on pocket. Has your tools ready when you need them. With trade credit folder case. Double sized, snap flap. See it at your jobber. If he cannot supply you write me. Illustrated folder of Radio Ser-vice Men. Write to: **GENERAL CEMENT MFG. CO. (Radio Division)** Rockford, Illinois. Write Alvin H. Bagg on request.

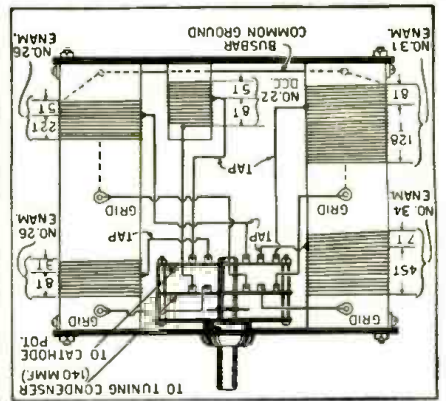

Number 14 tinned hard drawn copper wire is wound on a 1/2-in. dowel; 10 meters—16 turns; 5 meters—7 turns; 2 1/2 meters—4 turns.

This article has been prepared from data supplied by courtesy of Radio Constructors Labs.

A complete set of matched components for this set is available.

One metal-glass type MG-2525 tube.
 One metal-glass type MG-43 tube.
 One type 76 tube.
 Two metal-glass type MG-6K7 tubes.
 Three knobs.
 Two small bar pointers.
 One large bar pointer.
 One 1-5 switch plate.
 One "Volume" plate.
 0-100.
 One dial plate for ultra-high frequency tuner.
 One 4-in. airplane dial and escutcheon.
 One small insulation sub-panel with tip-jacks.
 One S.P.D.T. switch.
 One power cable, with 155-ohm resistor built-in and male plug.
 One closed-circuit jack.
 Two grid caps.
 One 5-contact socket.
 Four octal sockets.
 One resistor, 3 megs.
 One potentiometer, 50,000 ohms, with line switch.
 One potentiometer, 2,000 ohms.
 Two resistors, 0.5-meg.
 One resistor, 25,000 ohms.
 One resistor, 10,000 ohms.
 One resistor, 1 meg.
 One resistor, 0.1-meg.
 One resistor, 600 ohms, 1 W.
 One resistor, 300 ohms.
 One and two 25-mf. units.
 One filter condenser block containing one 10-µf. and one 25-mf. unit.
 Four fixed condensers, 0.1-mf.
 One fixed condenser, 0.05-mf.
 One fixed condenser, 0.01-mf.
 Two fixed condensers, 0.002-mf.
 One fixed condenser, 0.004-mf.
 One fixed condenser, 500 mf.
 One fixed condenser, 250 mf.
 One fixed condenser, 100 mf.
 100 mf.
 One semi-variable (compression type) condenser, 15 mf.
 field.
 One variable condenser, 15 mf.
 field.
 One dynamic speaker, 5 ins., with 3,000-ohm impedance.
 One filter choke (smoothing).
 One audio choke (amplifying).
 Two R.F. chokes, 25 mhy.
 One R.F. choke, 175 mhy.
 text).
 One set of high-frequency plug-in coils (see text).
 Five tapped coils and double 5-point switch.

LIST OF PARTS

and smooth tuning which is an absolute necessity for good long-distance reception.

The new metal tubes helps to attain the above

YOUR Future Is What You Make It...

THERE ARE ALWAYS GOOD JOBS FOR GOOD MEN!

Start Training Now!

"SERVICE AND PUBLIC ADDRESS ENGINEERING"

UNTRAINED men are eliminating themselves from the jobs that mean more and PAY MORE. CREI gives you the necessary training and background so essential for advancement and a real future. **CAPITOL RADIO ENGINEERING INST.** Dept. RC-6, 14th & Park Rd., Washington, D. C. Please send me complete details and illustrated literature regarding your new Course in Service and Public Address Engineering.

MAIL THIS COUPON FOR FREE 48-PAGE BOOKLET

Name
 Address
 City

Write today and learn the facts. Write while others remain in routine jobs. first lesson, giving you the "tools" to build a bitous serviceman. Practical right from the start. Illustrations of Radio Ser-vice Men. If he cannot supply you write me. Double sized, snap flap. See it at your jobber. If he cannot supply you write me. Illustrated folder of Radio Ser-vice Men. Write to: **GENERAL CEMENT MFG. CO. (Radio Division)** Rockford, Illinois. Write Alvin H. Bagg on request.

NEW YORK OFFICE
 14th and Park Road, N. W., Dept. RC-6, Washington, D. C.
 29 BROADWAY

STANDARD TRANSFORMER CORP.
 556 Blackhawk Street, Chicago, Illinois

MAIL THIS COUPON!

Name
 Address
 City

I am enclosing 10c for Amplifier Manual.
 Dept. C, 856 Blackhawk Street, Chicago, Ill.

These books should be in every amateur's technical library. They are invaluable for reference purposes. Just 22 cents in stamps, to cover postage, brings them both to you, or get them from any Standard Distributor. Send for your copies today.

AMPLIFIER
TRANSMITTER

On complete designs for public address amplifiers. Includes one for every purpose, from 3 Watts to 30 Watts output, with complete parts lists for each.

On complete designs for amplifier designs. Circuit designs and 8 section designs and 8 tested transmitter RF designs including 12 complete transmitter costs! One with 20 complete transmitter designs including RF modulator and speech amplifier designs. Circuits, complete parts specifications, inducances, etc. all included.

STANGOR

DESIGN DATA ON A.V.C. CIRCUITS

(Continued from page 718)

the chassis consists of a D.C. component, an R.F. component and an A.F. component. The condenser C1 has been placed across the resistor to pass most of the R.F. currents and the A.F. component is, of course, taken off to be applied to the grid by means of coupling condenser C. The steady voltage at P, which is proportional to the strength of the incoming signal, must now be fed back to the R.F. and I.F. amplifiers; but the A.F. component must be filtered out and precautions against interstage coupling should be taken.

THE "A.V.C. NETWORK"

This is accomplished by the network of resistors and condensers of Fig. 1A. Since the grids of the amplifying tubes are never drawing current, it does not matter, within limits, how much resistance there is between the point P and the individual grids. No voltage drop can develop across them because there is no current except in the case of overloading where very high values of resistance may cause tube blocking. Resistor R1 and condenser C2 form a resistance-capacity filter which smoothes out most of the A.F. fluctuations. That it does so is best seen from a consideration of the laws of alternating currents.

Since the condenser which is in series with the resistor R2, forms a path for alternating currents, a great part of the A.F. signal will pass through C2 in preference to following the paths through R3-C3, R4-C4, R5-C5. The percentage of the original A.F. voltage appearing across C2 is found as follows: Supposing R2 to be 1 meg., and C2 0.05-mf. which are popular values, the impedance of the condenser at 50 cycles would be 64,000 ohms. Adding this value vectorially to the 1 meg., we have

$$Z = 1,000,000^2 + 64,000^2$$

$$= 1,002,000 \text{ ohms (approx.)}$$

The percentage of the original A.F. voltage appearing across C2 is then $100 \times 64/1,002 = 6.2$ per cent. At higher frequencies the percentage is lower. This is the first filtering stage.

The resistor-condenser combinations in the grid-returns each form a second filtering stage which again may reduce the A.F. voltage to a few per cent of the remaining 6 per cent, thus bringing the final audio voltage down to 0.1-per cent of the original, or even less. The question is: how much resistance and capacity are required; and, is there such a thing as having too much of it? Yes, there is.

Looking again at the calculation of the filter above, it will be seen that halving the value of resistor R2 and doubling the value of condenser C2, would have given exactly the same degree of filtering. Consequently, it is the product of C and R which determines the filtering efficiency, and any two values of C and R whose product is the same will give the same degree of filtering. Also, the larger the product CR, the better the filtering.

TIME CONSTANT

The product CR is called the "time constant" of the resistor-condenser combination, for the following reasons: When a condenser is charged through a resistor, the voltage across the condenser increases with relative slowness following the logarithmic equation

$$E = E_{\text{Max.}} (1 - e^{-\frac{t}{RC}})$$

where E max. is the voltage of the course and $e = 2.718$.

Similarly, when a condenser discharges through a resistor, the voltage drops according to the law:

$$E = E_0 e^{-\frac{t}{RC}}$$

where E0 is the initial voltage across the condenser. Curves, showing the voltage plotted against time for both charge and discharge are shown in Fig. 1B. It can be shown mathematically that the general shape of these curves is always the same regardless of the size of the condenser or the resistor. It is then a relatively simple matter to calculate the time required for any degree of charge or discharge. The equations show that the only term which determines this duration is the product CR.

So, for instance, when $t = RC$, the fraction of the exponent becomes equal to -1 and in this length of time the charge of the condenser is

up to 63 per cent of its maximum value, or, inversely, the discharge is down to 37 per cent of the original value. The time constant, of a resistor-condenser combination then, is the time required to discharge the condenser through the resistor down to 37 per cent of the original charge (or to charge it to 63 per cent of the voltage of the source).

Another definition which also follows from the equation gives it as—the time wherein the condenser would charge or discharge completely if it kept charging or discharging at the initial rate.

Returning now to the A.V.C. circuit of Fig. 1A, if the strength of the incoming signal is suddenly changed, the negative voltage at the point P will change immediately but it will take some time before the condensers have been charged or discharged and it will take that long before the R.F. and the I.F. stages have adjusted their sensitivity. When this period is too long it becomes extremely difficult to tune the set because tuning past a strong station to a neighboring weak one, the sensitivity of the receiver is still lowered due to the strong carrier, and the weak station will not be heard unless extremely slow tuning is practiced. Similarly, when tuning to a strong station it will take some time before the receiver adjusts itself and during that time the set will overload.

The correct time constant is a compromise between the best filtering and the desired speed of following signal strength variations. The best values are between 1/10- and 1/20-second. For this circuit the time constant is equal to the product of R2 plus R3, and C2 plus C3. When the resistance is given in megohms and capacity in microfarads the time is in seconds.

Slight variations of the circuit of Fig. 1A will be found in most of the present-day receivers. The diode tube is generally a double-diode-triode, or a pentode, serving at the same time as the first A.F. stage. Sometimes a separate diode is employed for the detector. The two diodes are then coupled by a small condenser as shown in Fig. 1C. It will also be found that some of the resistors, R3, R4, and R5, may be absent. It depends on how much filtering the designer found necessary. These filters, of course, also serve to isolate the grid circuits of the different stages. But when the stages work at different frequencies (R.F. and I.F.) bypass condensers seem to be sufficient.

SEPARATE A.V.C. TUBE

Before the advent of the double-purpose tubes, it was necessary to provide a special tube for the A.V.C. circuit. Sometimes this tube required a voltage supply delivering up to 70 V. negative with respect to the chassis. Such a circuit, employing a triode tube—such as type 27—is shown in Fig. 1D. The same can of course be done with screen-grid tubes or pentodes (types 24A, 57 or 6C6). The signal is picked from either the plate or the control-grid circuit of one of the I.F. stages, and coupled to the control-grid of the A.V.C. tube through a small condenser. The tube rectifies the signal because the grid bias is adjusted to practically cut-off of the plate current. This will cause plate current to flow through the resistor, R1, and the point, P, again becomes negative with respect to the chassis. This negative voltage is passed along through the usual filter to the amplifying tubes.

VARYING THE SCREEN-GRID VOLTAGE

Sometimes in the past it became necessary to vary the I.F. gain by lowering the screen-grid voltage. This was done, especially, before there were any variable- μ tubes and in some dry battery sets. The manner of accomplishing this is illustrated in Fig. 1E. The screen-grid currents and the detector plate current pass through a common resistor, R1. As soon as a signal comes in, the detector plate current increases, thereby increasing the voltage drop across the resistor and lowering the screen-grid voltage. The system is not so successful with types 24A, 32 or 22 tubes because the amplifying stages will rectify with a low screen-grid voltage and this causes cross-talk. It can be used, however, with variable- μ pentodes.

This article has been prepared from data supplied by courtesy of Aerovox Corp.

This discussion will be concluded in Part II in a forthcoming issue.—Editor

Please Say That You Saw It in RADIO-CRAFT

A SENSATION THE SYLVANIA TECHNICAL MANUAL!



In Just 30 Days . . . The New Sylvania Technical Manual Has Caused A Sensation Among Radio Men All Over the Country!

● And why not? It's the most complete and informative manual Sylvania has ever published! Here are just a few of the features of this book.

1. A 50% increase in contents.
 2. 141 tube types listed with important circuit application information given on each type.
 3. Characteristics on all types are the latest, including all the standard types of metal tubes.
 4. A section on circuits has been increased to include 13 typical radio receiver and amplifier circuits which show proper use of the most popular types of tubes now being employed.
 5. Curve data on ballast tubes for battery sets.
 6. The convenient pocket-size has been retained in spite of the large increase in material.
- Send 15c for this new Technical Manual now! It will mean cash in your pocket.

Hygrade Sylvania Corporation, makers of Sylvania Radio Tubes and Hygrade Lamps. Factories at Emporium, Pa., Salem, Mass., and St. Mary's, Pa.

SYLVANIA

THE SET-TESTED RADIO TUBE

Hygrade Sylvania Corporation IC-66
Emporium, Pa.

Please send me the new Sylvania Technical Manual. I enclose 15c in stamps.

Name

Address

City State

BRUSH Hand Microphone

For describing athletic events, parades, crowds, etc., from press boxes, balconies, the tops of sound cars, etc., and for commercial interstation, police and amateur transmission work. Priced low. Fits the hand perfectly. Wide frequency response and typical Brush sound cell operation. No button current or polarizing voltage and no input transformer is required.

Size only 3 1/4 inches x 1 1/2 inches. Weight 3 oz. Output level minus 66 D. B. Shipped complete with 15 feet of cable. Can be furnished on special order with locking type plug and socket for stand connection. Details—Data Sheet No. 8. Free. Send for one.



BRUSH Headphones



—meet every headphone requirement. Response 60 to 10,000 cycles. No magnets to cause diaphragm chatter. Specially designed cases minimize breakage. Light in weight—Only 6 oz. complete with headband and cords. A quality product at a low price. Details—Data Sheet No. 10. Free. Send for one.



★ NEWS! ★ From AMPLIFIER HEADQUARTERS

HIGH FIDELITY ADVANCED DESIGN 16 WATTS—CLASS "A"

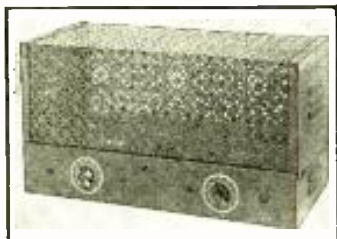

2 GAIN LEVELS 85 D.B.s AND 122 D.B.s
USES CRYSTAL OR RIBBON MIKES DIRECT
NO PRE-AMP. NECESSARY

- Separate Inputs for all Types of Mikes—Phono, Pick-Up and Tuner.
- Field Current for 2 Reproducers Independent of Filter Circuit.
- Built-In Acoustic Compensator.
- Built-In Multi-Tap Output Transformer.
- Oversize Power Transformer and Filters.
- 6 Tubes Including 6C5-6A6-1-6B5s Utilized in Exclusive Electronic Circuit Developed By Walter A. Carter.

PRICE NET **\$15.75**

Less Tubes and Speakers

COMPLETE WITH INSTRUCTIONS

2 ROLA 12" HI-FIDELITY SPEAKERS **\$6.95**

FOR ABOVE Each

GILLETTE RADIO CORP.

160 DUANE STREET NEW YORK, N. Y.

INTERNATIONAL RADIO REVIEW

(Continued from page 720)

FRENCH POWER-SUPPLY

THE FRENCH radio receivers, while they resemble American sets as far as circuit design is concerned, have marked differences in physical appearance from the latter.

Two of the main causes for these differences is the type of dials used and the appearance of the power supply transformers. A typical power transformer of French manufacture which was shown recently in *L'Accessoire et la Pièce Detachée* (Paris) is reproduced in Fig. B. It will be noticed that the top shield of the unit contains a tube socket and an insulated "jumper." The tube socket is mounted there for the rectifier tube of the receiver and the jumper permits changing from one line voltage to another; i.e., 110, 220 or the various other odd voltages found in Europe.

AUTOMATIC SELECTIVITY CONTROL

A NEW IDEA in set design which is the outcome of the variable band-width I.F. transformers used in high-fidelity sets is the "A.S.C." or automatic selectivity control system described recently in *Wireless World* (London) and shown in Fig. 2.

The A.S.C. system may be divided into three parts:

1. An I.F. amplifier with a tuned coupling system designed to reject the I.F. itself but pass frequencies in neighboring bands likely to cause interference. This amplifier is fed from the frequency changer in shunt with the regular I.F. amplifier.
2. A rectifier connected to the output of the A.S.C. amplifier whose function is to produce a steady negative potential proportional to the interference level. These two circuits (1 and 2) are seen in Fig. 2A.
3. A device controlled by the A.S.C. voltage in such a way as to lower the decrement of the I.F. tuned circuits (of the regular I.F. amplifier) as the interference increases, thus increasing the selectivity gradient. The third item is accomplished, as shown in Fig. 2B, by using variable- μ tubes as counter-regeneration control tubes. The regular I.F. coils are designed to have wide-selectivity under normal conditions, due to the "loading" effect of the counter-regeneration coils. As the interference increases, the A.S.C. voltage becomes greater, thus increasing the bias on the counter-regeneration tubes. This has the result of decreasing the loading on the I.F. coils, thus increasing the selectivity of the I.F. amplifier.

HIGH-FIDELITY SPEAKERS

SEVERAL new systems for increasing the frequency response of loudspeakers for high-fidelity response have been described recently in radio magazines. Two examples are shown in Figs. C and D.

The first example, shown in Fig. C, appeared in *Wireless World* (London) in connection with the description of a new receiver. In this case, a number of deflectors are placed in front of the speaker which is mounted in a baffle of the box type. These deflectors, some of which are pierced with oddly-shaped holes, serve to throw the sound from the front of the speaker in different directions, so that the sound does not appear to originate in a small, localized spot (the reproducer). The cabinet for this set has grilles, both in the front and sides, which allow the sound waves to pass unobstructed.

The second example at Fig. D is a German speaker system, described in *Europa Stunde* (Berlin), which is adjustable over the entire frequency range to supply any desired characteristic. As shown, the main speaker unit is mounted at the back. In front of the cone are 3 deflectors, two of which hinge from the bottom, so that their positions with relation to the cone can be changed. These deflectors cover only a part of the second compartment. Between them is another deflector, covering the entire compartment, and pierced with a large number of holes of various sizes. This deflector is hinged at the top. These deflectors serve to change the projecting efficiency of the sound chamber.

At the front of the sound compartment is a variable shutter which serves to reduce the opening of the sound compartment. In addition

to the main speaker unit, there are 2 tweeters, one of which is behind the shutter and the other mounted at the lower end of the front of the cabinet. These 2 tweeter horns are fitted with baffle plates along their length forming resonant chambers to increase the frequency range over which they will respond.

At the back of the main dynamic is a long compartment filled with glass wool which effectively suppresses the back-wave by providing a long path with plenty of sound-absorbing material.

EXPONENTIAL SPEAKER CONE

EFFORTS have been made, for some time, to correct the natural defects in reproduction of the dynamic cone, by the use of corrugations, special shapes, different cone materials, etc.

In a recent issue of *L'Accessoire et la Pièce Detachée* (Paris) a new cone of French design (which is used in a commercial speaker) was shown. This cone was made with an exponential taper, to combine to some extent the actions of air column and piston-type motive units. (See Fig. 3.)

It is claimed that much greater coverage can be obtained with a loudspeaker having one of these cones, in addition to the improved frequency response possible.

CAR-RADIO RECEIVER

A 2-BAND car-radio set of English manufacture is shown in Figs. E and F. This set, which is made by the Marconiphone Co., Ltd., covers the wavelengths of 200 to 550, and 1,000 to 2,000 meters.

The speaker box, which is mounted on the floor of the front seat of the car between the two seats, to project the sounds upward, also contains the "B" power supply. The latter is a vibrator-type unit.

The set uses 5 tubes in a superhet. circuit. The wave-change is accomplished by moving the tuning knob in or out.

MORE WIVES—MORE SETS!

Woman's Digest for May 1936 it has been pointed out by the feminine contingent of *Radio-Craft*, contains a "lead" for increased sales and service of radio sets that for effectiveness certainly takes the cake! Perhaps it is just as well, though, that the idea is not generally applicable in the United States!

"The Man with Nine Wives" is the title of the article in *Woman's Digest* magazine, from which is taken the following excerpt relating to a conversation on polygamy:

"Once," continued the polygamist, after a brief silence, "I brought Safia a radio. It was 11 a.m. when it was first turned on and at 11:05 Mesauda leaned her head coaxingly on my shoulder. 'Won't you make me a present of some music like Safia's, my husband? Do you now scorn your first wife?' To prove to her that such was not the case I bought her a radio. When Halima saw it she rushed to me. 'Halima,' she sighed, embracing me wildly, 'has given you five descendants, oh husband, and you deny to her what you give to others!' I bought another radio. Then Baya came and threw herself at my feet, wailing with anger. 'Am I so wretched, Abd-el-Aziz, that I don't deserve to be remembered? Let me return to my parents' home!' I bought her one so that she wouldn't leave me. I bought another for Leila to stop her crying. And another for Muny to keep her from committing suicide, and still another for Zohra to save her from a very convenient nervous breakdown. And one for Nadyema to prevent her from going on a hunger strike. And another for Aziza to get her to stop her shrieking.

"In the evening the following programs could be heard at one and the same time in my patio—a jazz band from Toulouse which was playing *Yes, We Have No Bananas*. A gentleman from Argel who was reading a weather report; a violin recital from Paris; some bagpipes from London interpreting a Scottish dance. A young lady from Milan who was singing *Goodby* from Tosca; a chorus from Barcelona singing a holy church song, and an orchestra from Moscow playing the *Internationale!*"

Please Say That You Saw It in RADIO-CRAFT

HOW DO WE HEAR?

(Continued from page 719)

of frequency, and the factors that determine the upper and lower limits of hearing. These limits, of course, vary with different people, depending upon the biological construction of the 3 bones as well as the entire intricate machinery comprising the organ of hearing. The intermediate frequencies, however, are readily transmitted by the 3 bones to the inner-ear and create vibrations in the liquid.

When a very complex sound enters the ear it consists of many fundamental notes and their respective harmonics. This sound is made even more complex in transmission by the 3 bones in the middle-ear, due to harmonics of the fundamental frequencies being set up by virtue of the vibrations of these bones.

"DETECTOR" ACTION OF THE MIDDLE-EAR

The action of these bones in this respect is quite similar to that of a detector tube in a radio set, where the impressed voltage on the grid does not produce correspondingly increased equal voltages in the plate circuit, thereby introducing or setting up harmonics and overtones. The sound vibrations therefore, which finally are transmitted to the liquid in the inner-ear, are extremely complex, yet as they pass up canal AB the various membrane areas are able to "pick out", so to speak, their respective frequencies to which they are "tuned" by nature. Consequently, a pure tone—a distinct pitch—will cause only a certain area to respond. A tone which is rich in harmonics will not only cause a particular area to respond but will also cause adjacent areas to respond in a degree depending upon the amount and the intensity of harmonics present. When any particular area is stimulated, the group of rods associated with it sends a nervous discharge to the brain at regular intervals, depending upon the loudness (magnitude of sensation of sound) and duration. The sensation of loudness or intensity therefore is determined by the total number of discharges from all the nerve fibers in the stimulated area.

We thus see that any one person's "opinion" of the tone of a particular radio receiver or other sound instrument is not a true picture of the capabilities of that instrument to reproduce various frequencies of sound!

(The writer is indebted to Bell Telephone Labs. and Western Electric Co. for courtesies extended in the preparation of this article.)

(This interesting condition is mentioned by John Mills in his book, "A Fugue in Cycles and Bels," recently reviewed in *Radio-Craft*. The condition is exaggerated when sounds become excessively loud, as the following quotation indicates: "The ear mechanism" [when overloaded] "reports to the brain the presence of vibrations which are not occurring at all in the air outside its drum. Its action gives rise to subjective tones—sounds real enough to the brain but having no counterpart of vibration outside the head and no external source of sound. The point where this distortion—for such it is—takes place is apparently in the middle-ear."

Going to opposites, Mills records that "subjective tones" may be created at very low levels of power—the brain in this instance being convinced of the presence of the fundamental of a note when the fundamental is not present in the vibration imposed on the ear drum!—Editor)

TIME SIGNALS ON 3 FREQUENCIES

THE U. S. Naval Observatory at Washington broadcasts time signals daily from the Naval radio station at Arlington, Va. These broadcasts take place at 11:58 a.m. on the following frequencies: 8,150, 12,225, and 16,300 kc.

The broadcasts start with a series of 1-second signals preliminary to sending the noon signal, the latter lasting exactly 3/10-second and starting at noon sharp after a period of silence of 10 seconds.

The time signals are sent out by automatic transmitters controlled from the Naval Observatory and are based upon intricate astronomical calculations. They give the exact Eastern Standard Time accurately to within 1/1,000 of a second.

This service has been in operation on other bands for many years and was originally sent out on a wavelength of 2,500 meters. Since it is so accurate it is used by many jewelers to set and check their timepieces.

TRY SPRAGUES

and note the difference



DON'T MISS THIS

Hot off the press comes the new 1936 Sprague Catalog brimful of new condensers, new ideas, new low prices, new service helps. Write for yours today! Save time by making duplicate replacements the Sprague Way! Get the new dope on Interference Elimination! See the complete new line of 450 volt condensers—the finest ever! Learn about the new Sprague mounting flange—and countless other features you can't afford to miss!

Remember: No need to check surges when you use Sprague's. You know they're right.

SPRAGUE PRODUCTS CO.
North Adams, Mass.

SPRAGUE GOO LINE CONDENSERS

AMERICA'S FINEST LINE OF QUALITY UNITS

THOR'S Latest P.A. 5-Tube Hi-Fidelity Amplifier

Has less than 2 dB variation between 20 to 14,000 cycles. Rated Gain 75 dB. Power output 16 watts continuously and peak of 20 watts. This sensational performer is built around the following tubes (1)-RCA83V—(1)-RCA56—(1)-RCA57—(2) 2 B6's. Tubes Specially priced at \$3.95

Completely wired and tested } less Tubes
Ready to operate } less Speaker **\$14.95**

Rola G 12" Hi-Fidelity speaker with output transformer to match\$9.95

Rola 12" K-12 speaker to match\$3.95

Order direct from this ad.

MAIL ORDERS PROMPTLY FILLED



167 GREENWICH ST. NEW YORK, N. Y.

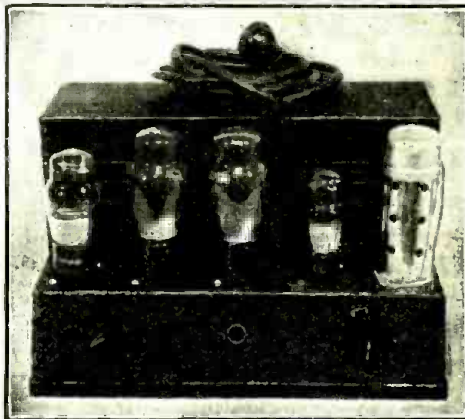

AT LAST!

AN EFFICIENT, PORTABLE, INSTANTANEOUS RECORDING and PLAYBACK UNIT

Complete with Stand Microphone • Recording on both Acetate and Aluminum
For Artists, Public Speakers, Voice and Music Teachers and Commercial Purposes

\$395.00 COMPLETE

DENCOSE INCORPORATED 1650 Broadway (at 51st) New York City

"If it pertains to sound—SEE DENCOSE"

POLICE CONVERTERS



FOR CAR RADIOS

Can be attached to any car radio. Has on and off switch and does not affect the reception on the standard broadcast band.

Model 100—Covers the entire police bands from 1500 to 2600 kilocycles. List Price 9.95

Can be adjusted to any frequency.

Model 100—Amateur's kit complete with assembly instructions. Price 5.95

Model 200—A new model with a variable condenser and an illuminated dial. Covers entire police and short wave bands from 1500 to 2500 kilocycles. When attached to a good car radio it makes a super police radio. List Price 17.95

Jobbers and dealers wanted.

ABC RADIO LABORATORIES

3334 New Jersey St. Indianapolis, Indiana.

FREE

Catalog of Radio Parts
Amateur Supplies and
P.A. Equipment . . .

All the newest equipment at new low prices. Every radio man will be interested in the new equipment for servicing metal tubes. Famous testing equipment sold on Easy Terms . . . Triplet, Readrite, Supreme, R.C.A., Clough Brengle and Triumph.

Write for Catalog 653 RC.

Sears, Roebuck and Co., Chicago

Please Say That You Saw It in RADIO-CRAFT

I'll train YOU QUICKLY for Good FULL-TIME and SPARE-TIME Jobs in ELECTRICITY

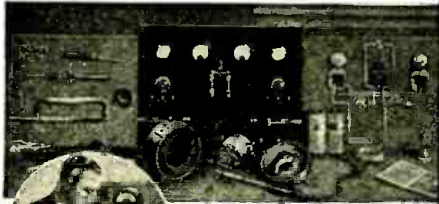

Get Into a Big Pay Field
for a Big Pay Future
Train in your Spare Time
by PRACTICAL Shop Methods

WITHOUT LEAVING HOME

Now, Electric Institute brings—TO YOUR VERY DOOR—practical training necessary for the rich rewards in Electricity. Keep your present job—no need to leave home—now you learn ELECTRICITY easily, practically—RIGHT AT HOME—in your spare time.

Prepare for Jobs Leading to Salaries of \$30, \$40, \$50 a Week

Get into a real money making field for a big pay future. There is no better way to succeed than to TRAIN for work in an industry that is expanding. New Electrical projects constantly mean more jobs for men with practical training. Almost every industry uses TRAINED ELECTRICAL MEN. Or you can own and operate an electrical business of your own.

Opportunities to Earn Up to \$5, \$10 a Week or More While Training

With this amazingly easy, fascinating method of HOME SHOP TRAINING it is possible to start EARNING MONEY almost at once. Do not confuse E. I. Training with dry, theoretical text book courses. Electric Institute tells you exactly WHAT to do—THEN YOU DO the ACTUAL JOBS with ELECTRICAL EQUIPMENT and APPARATUS which comes with your training at no extra cost.

Become a TRAINED man without leaving home or your present job—then be ready to step into a REAL ELECTRICAL JOB.

Money Back If Not Satisfied

You must be satisfied. I give you an agreement to return every cent you pay on tuition if, after completing my training, you are not satisfied in every way with my instruction, equipment or other services given you.

With my training, my graduates receive life time consultation service, employment service and many other features to help them succeed in Electricity.

Electric Institute is ready to show you the way in the great, growing field of ELECTRICITY—where trained men are ALWAYS NEEDED. Mail coupon TODAY—for big, free book of facts about this revolutionary Practical Home Shop Training and the tremendous opportunities in ELECTRICITY.

DIESEL ELECTRIC POWER, RADIO and REFRIGERATION



Take advantage of the opportunities awaiting trained men in these and many other branches of Electricity with ELECTRIC INSTITUTE practical training. Mail coupon for complete facts about ELECTRIC INSTITUTE—it may be the turning point in your life.

RUSH the COUPON—TODAY—BIG BOOK FREE

H. W. Petersen, President
Electric Institute, Inc., Dept. 156F.
5840 Addison St., Chicago, Ill.

Send Free Book with all facts about E. I. Home Shop Training.

Name.....Age.....
Address.....
City.....State.....

RECENT TUBE DEVELOPMENTS

(Continued from page 724)

to -8 V. bias. Therefore in order for this tube to operate in modern sets when connected in the A.V.C. line, which at times reaches a bias of -22 V., it was necessary to use a voltage-divider network to reduce the voltage applied to the 6E5 grid. The relation between the 6E5 control-grid voltage and the shadow angle is approximately linear; and so, with the proper A.V.C. voltage-divider network, the shadow-angle change on weak signals is small.

The inclusion of a triode unit having a variable μ characteristic in the cathode-ray indicator permits the application of A.V.C. voltage to produce an appreciable movement of the shadow on weak signals, and still prevent overload on strong signals. The type 6G5 cathode-ray tuning indicator, just announced by the National Union Radio Corp. is of this type. Figure 1 shows the connection of this type to the A.V.C. line and voltage supply of a set. Figure 2 shows the control-grid shadow angle characteristic. The tube is capable of handling approximately 22 V. negative bias directly on its control-grid, and so, in many instances, it is feasible to connect the control-grid directly to the A.V.C. voltage supply without the necessity of a voltage divider.

6G5 Characteristics

Heater voltage (A.C. or D.C.)	6.3 V.
Heater current	0.3-A.
Plate supply	250 V., max.

Target voltage	250 V., max.
Series triode plate resistor	1.meg.
Triode plate current for zero grid voltage	0.25-ma.
Triode grid voltage to give zero deg. shadow	-22 V., approx.
Triode grid voltage to give 90 deg. shadow	0 V., approx.

The 6X5MG. This tube is now available in a metal-glass equivalent of the metal type. It is made by National Union Radio Corp.

The 25A6MG. This type is also available in the metal-glass type from National Union. The characteristics of these two tubes are the same as the equivalent metal types which were previously described in *Radio-Craft*.

The MT Line. These "tubes" employ standard metal-tube casings and 8-prong octal bases—but here the resemblance to metal tubes ends. For they are not really tubes at all, but line voltage dropping resistors for the A.C.-D.C. series-filament type of sets, amplifiers, etc.

This new type of resistor which keeps the dissipated heat above the chassis where it belongs, and also eliminates fire hazards, is available in any total voltage drop and for practically all pilot lamp and tube combinations. Ballast action in the pilot lamp resistor section can also be provided.

HOW TO MAKE THE RADIO-CRAFT CAR-RADIO SET

(Continued from page 723)

- | | |
|--------------------------------------------------------------------|-------------------------------------------------------------------------|
| Two Continental Carbon resistors, 0.1-meg., 1/4-W., (D2), R1, R3; | One Electrad variable control with switch, 500,000 ohms, (203), R9; |
| One Continental Carbon resistor, 15,000 ohms, 1 W., (D2), R4; | One Electrad variable control, no switch, 25,000 ohms, (280), R16; |
| One Continental Carbon resistor, 60,000 ohms, 1 W., (D2), R5; | One General Transformer, tube-type multi-tap "B" supply; |
| One Continental Carbon resistor, 150 ohms, 1 W., (D2), R2; | One Raytheon 6A8 metal tube; |
| Two Continental Carbon resistors, 1,000 ohms, 1 W., (D2), R6, R17; | Two Raytheon 6K7 metal tubes; |
| One Continental Carbon resistor, 0.5-meg., 1/4-W., (D2), R7; | One Raytheon 6H6 metal tube; |
| One Continental Carbon resistor, 0.05-meg., 1/2-W., (D2), R8; | One Raytheon 6F5 metal tube; |
| One Continental Carbon resistor, 0.5-meg., 1/2-W., (D2), R15; | One Raytheon 6F6 metal tube; |
| One Continental Carbon resistor, 0.25-meg., 1/2-W., (D2), R13; | One remote control head, 6-1 ratio, for condenser closing right, (600); |
| One Continental Carbon resistor, 0.1-meg., 1/2-W., (D2), R12; | One gear reduction for attachment to condenser, (104); |
| One Continental Carbon resistor, 600 ohms, 1 W., (D2), R14; | One steering column, instrument, or dash mounting units for 600 head; |
| One Continental Carbon resistor, 2,000 ohms, 1 W., (D2), R10; | Two flexible shafts to chassis mounting brackets (optional). (P-3119); |
| | One coupling for volume control to flexible shaft, (P-4524); |
| | One shielded 5-connector cable, 3 ft., (1166); |
| | One low-capacity cable, 1/2-in., 3 ft., (1196), OD; |
| | One shielded cable, 3 ft., (1205); |

The chassis drilling layout—useful when specified parts are used.

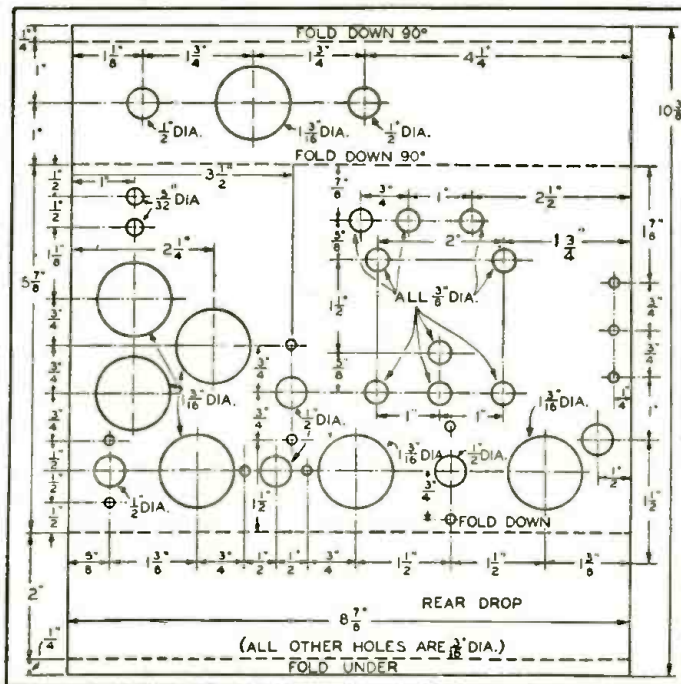

Suggested Accessories:

- Eight, 6 or 4 Continental Carbon universal suppressors, (S-27);
- One (either) Continental Carbon cable suppressor, (C11); (or) Continental Carbon distributor suppressor, (T13); (or) Continental Carbon distributor suppressor for Ford V-8, (T14);
- One (either) Aerovox suppressor condenser, 0.05-mf., (1140); (or) Aerovox suppressor condenser, 0.05-mf., for Ford autos, (1150);
- One Aerovox ammeter condenser, (1160);
- Two black knobs;
- 25-ft. roll push-back wire (1035), No. 18 solid copper;
- Four grid caps for metal tubes;
- Two lengths (from 2 to 3 ft. each), remote control flexible shaft;
- Two lengths to match, flexible shaft casing.

Please Say That You Saw It in RADIO-CRAFT

THE "ANTI-HOWL" AUDIO AMPLIFIER

(Continued from page 725)

speaker's voice) are undesirably amplified. 8. Phonograph records sound unduly confined in volume range, and are excessively "scratchy."

9. No adequate indicator is available to show maximum safe power output or gain limits before feedback occurs.

10. Although individual frequency runs on each of the major components of the P.A. System (microphones, amplifier and speakers) show high-fidelity characteristics (less than 5 db. variation between 50 and 7,500 cycles), a frequency run on the complete interconnected system discloses decided non-high-fidelity characteristics (12 db. variations between 50 and 7,500 cycles).

All P.A. men who have had any experience with sound systems of any kind have noticed at some time or other at least 50 per cent of the above-listed defects in every P.A. installation, but have failed to recognize them as such—and simply accepted them as necessary evils.

From an engineering standpoint, once the faults are definitely known to exist and are carefully analyzed it becomes a relatively easy matter to design a high-fidelity A.F. amplifier capable of suppressing feedback, maintaining a constant output, automatically controlling gain, suppressing external noises, providing high-fidelity output at low and high levels, extending the output range, and utilizing a cathode-ray device for control indication.

ANALYZING "HOWL" CONDITIONS

Feedback has undeniably been the worst "bugaboo" of most P.A. men. The author has answered literally thousands of letters requesting advice and methods of eliminating this annoying phenomenon. While it is true that an acoustic engineer will invariably say, "Put sound-absorbing material at all points where sound reflection takes place, or sound proof the microphone compartment, or change the shape of the interior so as to attain ideal acoustic conditions." (!), the P.A. rental specialist finds himself helpless with this bit of honest but useless advice; for drapes cost money, stages cannot be conveniently sound-proofed, and interiors are usually not redecorated by the management for a one-night P.A. installation.

It, therefore, becomes apparent that the direct cause of feedback cannot be readily removed; the sound system engineer is now faced with the problem of eliminating audio howling in the presence of its direct cause.

A casual observation of the problem leads one to infer that its solution is impossible under the imposed conditions. A deeper consideration and study of the phenomena involved will disclose the following interesting facts:

1. For every type of P.A. installation, regardless of acoustic conditions, there is one best selection and arrangement of microphones and speakers.

2. With a given arrangement, feedback always starts at the same volume-control setting.

3. Some satisfactory control setting permits maximum microphone pick-up without feedback.

4. When feedback takes place, with a given volume setting, its output level is higher than the peak values of speech.

From these facts it becomes apparent that audio howl can be eliminated by rectifying its peaks and applying the rectified voltage as a varying bias into the input tube so to decrease its gain and subsequently lower the output level below its "spill-over" or threshold point. (See Fig. 1. These graphs do not conform to strictly sine forms but are a compromise with drafting convenience, and as such are representative of the general operations involved in the discussion.—Editor) The fundamental circuit shown in Fig. 2 is a virtual limited "signal contractor" or compressor of this order which rectifies all peaks above a predetermined level to automatically lower the output level of the amplifier.

ANALYZING THE NEW "ANTI-HOWL" CIRCUIT

As will be noted, the power output tubes are coupled through two 0.005-mf. condensers to the separate cathodes of a 6A6 tube which acts as a biased rectifier. When an A.C. signal appears across both cathodes rectification takes place only when the positive bias on the cathodes (supplied through resistors R1, R2, and R3)

fails to equalize the negative audio peaks produced by the power output tubes. These negative peaks are rectified and appear as a negative voltage across R4. The voltage is then further filtered through the isolating resistor R5 and fed into the sharp cut-off grid (G3) of the 6L7 input tube and howl suppressor. The no-signal bias of this grid is adjusted so that its G1-to-plate transconductance is relatively high. When a rectified negative voltage appears across the rectifier output, it increases the bias of the sharp cut-off grid, G3, and decreases the transconductance of the G1-to-plate section. The decrease in gain is approximately proportional to the rectified diode voltage and, hence to the peak extending above the feedback threshold. The lowered gain causes the output level to automatically decrease. This reduces the A.C. voltage across the cathode of the 6L6 peak rectifier to some point below its positive bias and stops its rectifying action. During the inactive periods of the rectifier, the bias on the sharp cut-off grid increases, with a subsequent increase in gain. By this action peaks extending into the feedback region are instantaneously suppressed.

The speed of the suppressor action is dependant upon selection of the resistor-condenser combination in the rectified output circuit. If its action is too slow, feedback suppression will take place with "motorboating" action. If suppression takes place too rapidly, voice peaks rising above the feedback threshold, but of too short a duration to set the system in a state of howl, will be cut off. It is essential, therefore, that the time constant of the system be adjusted so that feedback is suppressed before it attains any appreciable degree of volume. Time constants of 1/25 to 1/50 of a second have been found satisfactory.

A practical amplifier that embodies this anti-howl feature, as well as the others listed in Table I, has been developed by the writer, as shown in the heading illustration, but because of space limitations continuation of the discussion of this advanced-design amplifier and its many revolutionary features has been found necessary, and will be found in future issues of *Radio-Craft*. In the meantime, the author will be pleased to answer all questions and offer suggestions for any particular type of P.A. installation. Address all letters care of *Radio-Craft*.

RAISING FUNDS FOR THE INSTALLATION OF POLICE RADIO SYSTEMS

SO important has the use of police radio systems become that many of the cities lacking the funds necessary for such installation have raised the money by popular subscription. Many sorts of activities have been used, ranging from comprehensive campaigns to individual entertainments and other affairs planned to raise as much revenue as possible.

Most of the initiative has been taken by police officials who are in a position to know the value of radio service and who can speak authoritatively on the subject thus arousing other key men and finally the whole community.

Among those communities which have raised funds in such a manner, according to the Western Electric Co., are Findlay, Ohio; Green Bay, Wis.; and St. Joseph, Mo. These cities range in size from 18,000 to 40,000 population. The equipment obtained by these 3 is respectively, a 500-W. transmitter, a 100-W. transmitter and a 2-way, ultra-high frequency system with a 50-W. transmitter and 12 to 14 cars, each with receivers and 5-W. transmitters.

The campaign at St. Joseph was initiated by Mr. Charles Enos, Chief of Police. A policemen's ball was organized and extensively publicized as the Police Radio Fund Ball. Individual tickets were sold at \$1.00 each, and patron's tickets were sold to the larger industrial organizations, banks and stores at \$10.00 each. The affair was a great success, as the Ball cleared \$6,500, which the City Council offered to double.

Other schemes, such as wrestling matches, picnics, barbecues, and so on have been used. Most of the reported campaigns have taken place in the middle-west.

Please Say That You Saw It in RADIO-CRAFT



Great CATALOG with Everything in RADIO

4 great books in one—not merely an "Amateur's Supply" pamphlet—nor a "Servicemen's Supplies" leaflet or a "Public Address" circular—or a "Set-Builders' Booklet"—but Radio's Leading Supply Guide—COMPLETE with EVERYTHING for EVERYONE in radio—that's the new ALLIED Spring and Summer Catalog for 1936. A complete book, a man's-size book, an honest book, with 136 value-loaded pages, 4 complete handy sections—a luxurious Public Address section, an elaborate "Ham" section, a newly revised Set-Builders' section, a handy Service Section—all combined to make your radio buying easier and more economical. For real convenience, for genuine value, for low price—shop your new ALLIED Catalog.

Read the elaborate Amateur section—a tremendous assortment of receivers and transmitters to meet every Ham requirement. Also dozens of build-your-own kits. Servicemen! Extraordinarily complete lines of standard, nationally known test equipment; thousands of parts, tools, accessories, books, etc.

P. A. men! Pages 19-36—a panorama of the finest assortment of sales-clinching, profit-making sound outfits and P.A. equipment that you ever laid eyes on. 5 to 50 watts; permanent and mobile—a sound system for every need. Send your specifications to our Sound Engineering Division for valuable advice and low cost estimates, free of charge.

Radios—page after page of the newest finest sets ever offered. Actual 1937 models. 4 to 11 tubes; short wave, dual wave, all wave, auto, 6 volt and battery sets. Astounding new "Teleye" sets; de luxe phono-radio combinations in beautiful table and console models. And—special—the amazing new Farm Power units. WRITE NOW FOR COPY.



FREE Spring & Summer CATALOG

ALLIED RADIO

ALLIED RADIO CORP. Dept. D.
833 W. Jackson Blvd., Chicago, Ill.

Send me your FREE Spring & Summer Catalog.

I am especially interested in.....

Name

Address

City State.....

HERE'S MONEY MAGIC

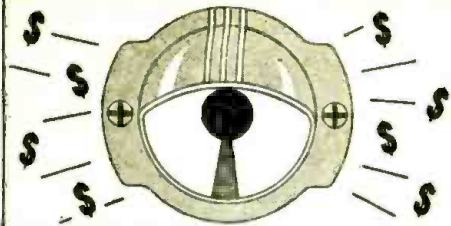

FOR SERVICE MEN

hurry! get full details on the

NATIONAL UNION CATHODE RAY TUNING KIT OFFER!

Free Post Cards on Every Offer to Create Sales. Send Coupon Now!

NATIONAL UNION RADIO CORP. of N.Y.
570 Lexington Avenue, New York, N.Y.

Rush Details of Tuning Kit Offer!

Name _____ RC638
Street _____
City _____ State _____

KADETTTE

THE POWERFUL RADIO WITH MARVELOUS TONE



- SEVEN TUBES
- SUPERHETERODYNE
- FOREIGN AND DOMESTIC
- SHORT WAVE AND STANDARD BROADCAST
- DYNAMIC SPEAKER
- AC-DC

BEAUTIFUL AMERICAN WALNUT CABINET
Only **\$26.95**
A \$40. Value

Write for full information
INTERNATIONAL RADIO CORP.
ANN ARBOR, MICHIGAN

IMPORTANT FACTS ABOUT SCHOOL SOUND SYSTEMS

(Continued from page 724)

A amplification is a circuit in which a definite amount of "C" bias controls the amount of plate current which flows through the tubes at all times. No shift of this plate current is allowable either upward or downward, and no grid current is drawn. The "C" bias is introduced in this case through the filament supply circuit and is termed as self- or "automatic" bias. (A clearer picture of this can be obtained by referring to the curves obtainable from tube manufacturers.)

In this class of amplification the load resistance from plate to plate should be fairly high—at least twice the optimum value of the tube resistance. This is governed by the dynamic characteristic of the tube and the slope of this curve corresponds to a resistance equal to the plate resistance of the tube plus the load resistance. The grid potential in this class of amplification must never be allowed to turn positive. (This is not to be confused with the positive side of the cycle.) This is to avoid amplitude distortion, and the dynamic characteristic of the tube must form (practically) a straight line over the entire operating range. When the conditions under which this circuit is operated are such that when the sine-wave signal voltage has the proper amplitude to balance out the grid voltage to zero during the positive half-cycle and at this point just slightly reduces the plate current to the minimum allowable value at the crest of the negative half-cycle, then it is that the maximum output of the amplifier is obtained.

This can only be accomplished when the proper balance is established between the plate supply voltage, grid bias voltage, plate resistance, and load resistance. The crest value of the signal voltage is therefore limited to the value equal to the grid bias value so that the grid will not become positive. Further, the grid bias value establishes the operating point of the tube so that the sine-wave signal voltage can reach the limit of zero instantaneous voltage, on the positive half-cycle with a simultaneous action on the minimum allowable plate current on the negative half-cycle, so that the operating point is placed in the tubes where the maximum power output can be obtained. This point is where the dynamic characteristic of the tube crosses the proper load resistance.

MAXIMUM UNDISTORTED OUTPUT

The power supply must furnish enough plate voltage and plate current at the operating point of the tubes and the presence of the signal makes no change in this product. When no signal is present in the tubes the plates of these tubes dissipate this voltage and current, which makes itself present in the form of heat. When a signal is impressed upon the grids of these tubes this heat which is a loss in plate efficiency is then reduced by an amount equal to the output of the amplifier. Plate efficiency cannot exceed 50 per cent, no matter how efficiently the circuit may be designed. This 50 per cent efficiency can only be realized:— first, when the grid voltage, plate current, and characteristic curves are straight lines; and second, when the load resistance is very high with respect to the tube resistance. In large tubes that use more than 1,000 V. on the plate, the safe value of the plate power dissipation in relation to the corresponding maximum undistorted power output will be exceeded. In this case the plate current "draw" of the tubes should be reduced by increasing the negative grid bias. This will allow the use of a higher load resistance which will give increased plate efficiency if you were to reduce the plate voltage and lower the load resistance.

The load resistance can be increased to as much as 4 times the value of the tube resistance without materially affecting the plate efficiency, provided proper adjustments are made in the plate current and the negative grid bias of the tube. The gain in output that can be derived from a given signal when the circuit is properly adjusted for maximum power output is $1\frac{1}{2}$ times. This means that in order to realize this output the signal must be $1\frac{1}{2}$ times as large as the signal required to obtain maximum output when the load and plate resistances are equal. But to obtain a greater output from the tube a high-resistance load is required which reduces the dynamic curvature and increases the plate efficiency. This

requires less plate current. A high load resistance reduces the harmonic content. This is caused by changes in the plate resistance in series with the load resistance which causes curvatures in the dynamic characteristics of the tube. A high load resistance makes the variations of the plate resistance negligible.

DISTORTION

In calculating non-linear distortion we must use the actual dynamic characteristics, as the curvature of these characteristics bring about distortion.

First, let us establish the operating point on the dynamic characteristic (i.e., a point where the plate voltage and grid bias correspond for no-signal). We will designate the plate voltage by E_p and the plate current by I_p . Now we can determine the points for the load resistance R_L at the point where the plate current, I_p' , crosses the dynamic characteristic curve E_p minus I_p and the plate voltage curve, E_p'' , so that we have the following relation $R_L (I_p' - I_p) = E_p' - E_p''$. This shows the voltage drop through the load resistance by the difference between the plate current at the operating point and the plate current at the point in question. This is the amount by which the plate voltage at the point in question differs from the plate voltage at the operating point.

By the use of the above equation we can calculate any point for a given load resistance. Further, from the dynamic characteristics we can determine the relationship between the plate current and the grid voltage which determines the waveform of the output. In the case where the dynamic characteristic is a straight line over the complete range and the waveform of the output is an exact duplicate of the signal, no distortion has been introduced provided of course that the grid has not turned positive. But in a case where the dynamic characteristic is not a straight line, or in other words is not proportional to the signal, amplitude distortion is the result. Further, this amplitude distortion produces harmonics and also brings about rectification of the signal in the plate circuit.

The usual form of load resistance to match the tube impedance is a transformer: termed *output transformer*. Tubes are matched to a load, in almost all cases, in this manner, the load being connected across the secondary, and the plate voltage and current being fed to the primary through the tubes. This output transformer transforms impedances in proportion to the square of its turns ratio. If the ratio of the primary to secondary is N , an impedance Z_1 across the secondary is equivalent to (as far as the primary terminals are concerned) an impedance, $N^2 Z_1$ across the primary. If we designate the load impedance as Z_L and an impedance Z_p for the plate circuit of the tube, then the ratio N can be calculated from $\frac{\sqrt{Z_p}}{Z_L}$. The core

must be of such design that no saturation can take place; and the number of turns in the primary inductance, L_p , must be great enough so that we have an inductive reactance value equal to $N^2 Z_L$, for the lowest frequency that is to be transferred to the load.

The reactive component of an amplifier is calculated in the same general manner as the *resistance* component with the exception that the dynamic characteristic takes on the shape of an ellipse. This is because the signal plate current is out of phase with the signal grid voltage. The formulas for calculation of reactance are so complex that it is not worth while to calculate them due to the fact that the results do not warrant the effort expended (for practical purposes) because all intersecting points of the ellipse must be considered as straight lines. This same argument also holds good for *power factors*. In this respect we may mention that whenever the load power factor is reduced and the impedance is not changed the grid bias must be decreased.

PHASE EFFECTS

Tubes in a push-pull circuit have a lower distortion factor than either single or paralleled tubes. This is due to the phase relation in the push-pull circuit as the tubes are 180 degrees out of phase which means that one operates on the

Please Say That You Saw It in RADIO-CRAFT

SPRAYER OUTFIT

ELECTRICAL—PORTABLE

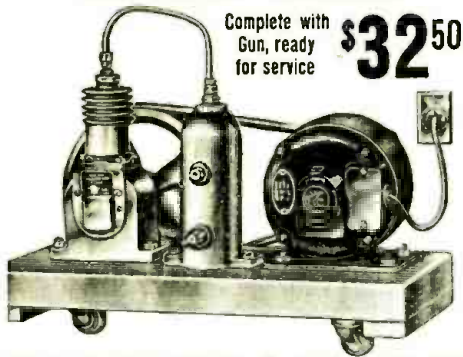

Complete with Gun, ready for service **\$32.50**

This is the ideal outfit for all around spraying work wherever current is available. Sprays everything: Lacquers, Oil, Cold Water Paints, Enamels, Varnish, Insecticides, Disinfectants, Shoe Dyes, etc. The Unit is compact, completely self-contained. Ideal for spraying Furniture, Radiators, Screens, Machinery, and other maintenance paintings in Homes, Schools, Clubs, Hospitals, Stores, Factories, and Office Buildings.

The Gun furnished with this Unit is of Pressure Cup type, requires but 2 cu. ft. of Air per minute. Has Bleeder type construction which assures uniform pressure at all times without clogging the Air Passage which is easily cleaned. Furnished with 3 Nozzles which produce Fan, Round, and Right Angle Spray respectively. Complete Unit consists of Air-cooled Compressor with machined Fan-cooling Pulley, V-Belt Drive; Pressure type Gun with 1 quart Aluminum Paint Cup; 3 Pins; 1/4 H.P. Heavy Duty Motor, 110/120 volt, 60 cycle, AC; 15 ft. rubber covered 2 Ply Air Hose; 8 ft. Cord & Plug; Filter Tank; Entire Unit mounted on Base with Ball Bearing Casters.

A low priced Power Sprayer: the kind of Machine that usually sells for \$50.00 to \$60.00.
 Price of complete outfit, shipping weight, 60 lbs. **\$32.50**
 Price of outfit complete, less Motor, shipping weight—35 lbs. **\$25.50**
 Price of Gun only with 3 nozzles, shipping weight, 7 lbs. **\$7.50**
 Price of Compressor only, shipping weight 15 lbs. **\$9.50**

Our Old Customers Know That Our Merchandise Is Sold on a Strict Money-Back Guarantee

All Shipments will be forwarded by Express Collect if not sufficient postage included with your order.

WELLWORTH TRADING CO.

560 W. Washington Blvd., Dept. RC-636, Chicago, Ill.

Something NEW!

WEATHER FORECASTER AND HUMIDITY TESTER

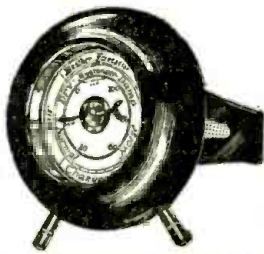

"HYGROSCOPE"

The Ace of Weather Forecasters

When placed in a well-ventilated room or in the fresh air, the HYGROSCOPE foretells coming weather conditions from eight to twenty-four hours in advance. It also accurately records outdoor humidity, and when placed inside it gives the humidity within the house or room.

The HYGROSCOPE is automatic self-adjustable, simple American-precision made. It cannot get out of order at any time. The dial measures 2 3/4" is enclosed in a 6" round hardwood case, with either walnut or mahogany finish. It is attractive for desk or living room.

OUTSIDE DIAL FORECASTS WEATHER

Fair—rain—or changeable is indicated on the outer dial when the HYGROSCOPE is placed in a well-ventilated room or out-of-doors. If indoors, place the instrument near an open window.

INNER DIAL SHOWS HUMIDITY CONTENT

The HYGROSCOPE also acts as a hygrometer. Numbers on the inner dial indicate the degree of humidity present in the air and in artificially heated rooms.

SEND YOUR ORDER NOW! Get your HYGROSCOPE today. Your remittance in form of check or money order accepted. If you send cash or unused U. S. Postage Stamps, be sure to register your letter. Also specify if you prefer the HYGROSCOPE in Walnut or Mahogany. **\$2.00**

Postpaid

GREN PARK COMPANY

Dept. RC-636

99 Hudson St. - New York, N. Y.

positive half-cycle while the other one operates on the negative half-cycle. This is only in regard to the signal potential, and this further means that distortion which is introduced in one tube when it is operating on the positive half-cycle is also introduced simultaneously in the other tube when it is operating on the negative half-cycle. This means further that in a push-pull circuit no even harmonics can be generated in the output as the even harmonics would have a different waveform, and, due to the simultaneous operation of the tubes any unsymmetrical waveform is balanced out. The elimination of the second harmonic permits a higher power level output. The D.C. plate current flowing through the two primaries in opposite directions cannot cause core saturation even though the tubes draw large amounts of current; which makes the push-pull circuit more efficient than single or paralleled tubes. Further, due to the same facts, the signal cannot back up into the power circuit which would cause feedback.

It is further possible to use plate voltage from a source that does not have to be highly filtered. This is because the A.C. components are in phase with the plate circuits of the two tubes. This cancels out in the secondary of the output transformer.

Where an input transformer is used to couple the grids of the push-pull tubes to the plate circuit of the preceding tube the secondary of this transformer must be center-tapped. The secondary should be wound in symmetrical halves so that the characteristics in both tubes are alike.

Do not subject the circuit to sudden current breaks when the power supply is in operation. This will produce voltage surges, the voltage being built up in the inductance through which it flows to several thousand volts. So, do not pull a tube out of its socket or disconnect the "C" bias resistor while the power is turned on as the transformers are liable to break down.

*Copyright 1935 by R. H. von Liedtke. All rights reserved. Not to be reproduced in whole or in part in any form whatsoever without written permission of the copy right owner.

Our Information Bureau will gladly supply manufacturers' names and addresses of any items mentioned in "Radio-Craft." Please enclose stamped return envelope.

SCHOOL "TALKIES"

In concluding this article on sound in the school, the editors of *Radio-Craft* wish to call attention to the fact that 16 mm. talking motion picture equipment is rapidly reaching a very important position; foresighted technicians will do well to investigate both the existing and the potential scope of this field, with regard to the installation and service of such equipment.

As pointed out in a past issue of *The Kappa Alpha Journal*, there are more than a quarter-million schools in the United States, every one of which is a logical prospect not only for P.A. but also for talkies apparatus, and the subsequent service of this equipment.

In but a relatively short time the greater proportion of these institutions will be fully equipped with such modern aids to education, and at that time, those who now "get in on the ground floor" will be "sitting pretty." In furtherance of this trend, *Radio-Craft* will devote space to any letters or articles of exceptional technical interest, from readers, concerning "audiovisual" (talkies) and P.A. (public address) installations in schools of all types.

A NOVEL P.A. INSTALLATION

THE American Crayon Co. of Sandusky, Ohio has been conducting a huge drawing contest among school children of the Chicago district. The contest was preceded by a widespread merchandising campaign with the result that the local sales personnel of the company were kept in a state of feverish excitement.

Frequent conferences were held in the offices of Forf, Browne and Mathews, the advertising agency conducting the contest. To enable Mr. Knouff, sales manager of the crayon company, to address his men at these meetings, the Standard Transformer Corp. installed an amplifying system that was inductively connected to the telephone circuit. The voice coming over the long distance telephone system was then amplified so that it could be heard by all at the meetings. Thus the sales manager could address his force at a distant point without leaving his other duties.

Train at Home Under FACTORY ENGINEERS for GOOD PAY Spare-Time and Full-Time Jobs in RADIO



LEARN TO EARN UP TO \$75 A WEEK

If you're dissatisfied with small pay—and an uncertain future, get my big FIVE book, "RADIO'S FUTURE AND YOURS." This book tells how you can learn at home under the supervision of factory engineers to make more money almost at once in Radio—how to make Radio your life's work, or how to earn \$5 to \$20 a week extra in your spare time.

MORE OPPORTUNITIES THAN EVER BEFORE

1935 was Radio's biggest year. Over 5 million new sets sold. Over 30 million dollars paid for service alone. Where only a few hundred men were employed a short time ago, thousands are employed today. And where a hundred jobs paid up to \$75 a week—there are thousands of such jobs today—many paying even more. New full time jobs and spare time jobs are being created all the time.

"SHOP TRAINING" FOR THE HOME

R-T-I Training is different. It comes to you right out of the factories where Radio sets and other vacuum-tube devices are made. It was planned and prepared and is supervised by radio engineers IN these factories—by men appointed for the purpose. R-T-I will train you as the Radio Industry wants you trained.



BIG MONEY IN AUTO AND POLICE RADIO WORK

W. H. Carr, 402 N. 16th St., Kansas City, Kans., R-T-I student has charge of 35 radio equipped Police cars. He gets \$230.00 a month and free auto, gas, oil, etc. He says, "If I had not taken your course I would not be able to hold this job."



MAKES \$600 IN ONE MONTH

Herbert B. Thomson, Gorman, Texas, started making money with 12 lessons finished. He says, "Because of my R-T-I Training I made \$450 in September and over \$600 in October, 1935. It pays to be R-T-I Trained."

TELEVISION, PHOTO ELECTRIC CELLS, PUBLIC ADDRESS SYSTEMS INCLUDED

Radio service work is plentiful but it's only the starting point in R-T-I Training. From there you'll go through the whole field of Radio and Electronics. You will learn about every new development, including Television so you'll be ready when Television breaks.

4 WORKING OUTFITS FURNISHED

Start almost at once doing part time radio work. I furnish 4 outfits of apparatus that you build into test equipment with which you can do actual jobs and earn extra money. My training pays its own way, and you get your money back if not satisfied. Age or lack of experience is no handicap.

FREE BOOK

Find out why R-T-I Trained men get "Quick Results" and "Big Results." Send for "Radio's Future and Yours" today. It tells about Radio's amazing opportunities. It describes my approved training—what R-T-I students are doing and making. It gives the names of 50 firms who endorse and recommend R-T-I. It's FREE.

Ray D. Smith
 President Radio and Television Institute
 Dept. 22A
 2150 Lawrence Ave., Chicago

MAIL COUPON FOR FREE BOOK

RAY D. SMITH, President
 Radio and Television Institute (R-T-I)
 2150 Lawrence Ave., Dept. 22A
 Chicago, Ill.

Without obligating me, send FREE Book about spare-time and full-time Radio opportunities and how I can train for them at home.

Name

Address

City State

Please Say That You Saw It in RADIO-CRAFT

TYPE JR

ELECTROLYTIC CONDENSERS

NEW — The "Dwarf-Midget" electrolytic that will do the work of a "Goliath".

SERVICE OVER 5,000 SETS WITH ONLY 30 CONDENSERS!

Tiny—Silver Coated—Cardboard Containers. Equipped with color coded wire leads and handy mounting feet. Extremely small 450 volt working condensers.

8 mfd. JR-508 525 V.D.C. Peak
2 7/16" x 1 1/8" x 1 1/16" list 95c

Cornell-Dubilier condensers are the first choice of radio servicemen. Write for catalog No. 131.

CORNELL-DUBILIER CORPORATION
4347 BRONX BOULEVARD
NEW YORK

THE PERFECT CODE TEACHER! NEW MASTER TELEPLEX

For beginners, experienced operators, and schoolroom. The sure easy way to learn code and to step up your speed. This amazing new instrument will record your own sending on double row perforated paper and repeat it back to you at any speed you desire. 10,000 words can be recorded on one tape.

No Batteries
No Winding
All Electric

Buy It or
Rent It

It is the same in principle; and in operation is equal to the Wheatstone Perforator and Transmitter, which cost over \$1,000.

Send for Folder A6, which tells you how to get the use of this instrument without buying it. No obligation. We furnish complete course and personal instruction with a money back guarantee. Low cost, easy terms. Write today for information.

TELEPLEX CO.

72 Cortlandt St. New York City

The New Master Teleplex—"The Choice of those who Know"

UNBREAKABLE P. A. TRUMPET



A radically new type of sound projector made of the specially processed RACON ACOUSTIC STORMPROOF material, with full-length bell reinforcement. Demountable in three sections, with cast aluminum throat and section couplings, with loose coupling for unit attachment. Unquestionably the strongest, most durable trumpet available, with characteristic RACON high acoustic efficiency.

Racon Electro-dynamic Units and Horns are manufactured under 14 exclusive Patent Patents.

Write Dept. RC636 for catalog.

RACON ELECTRIC COMPANY, INC.
52 East 19th St., New York, N. Y.

MEMBERS' FORUM

(Continued from page 728)

member of ORSMA since its organization. I think your magazine is the best Service paper published! There have been so many good articles on most every instrument in the service field, both constructional and commercial. For myself, I like the constructional articles best, particularly those on service equipment.

I am very much interested in the construction of a good low-speed "windcharger." Suppose we Service Men petition *Radio-Craft* for a complete constructional article in the near future on such a unit.

W. G. GORDELL,
Oklahoma City, Okla.

We believe such an article would be of rather widespread interest. It could use a discarded auto-type generator but should otherwise be entirely home-made. If any of our members (or otherwise) have made such a unit, and find it successful, let us know.

Thanks for "them kind words" in your opening paragraph.

A LIVERPOOL "RADIO-CRAFTER" SUGGESTS A "DATA EXCHANGE"

RADIO-CRAFT, ORSMA Dept.:

I am in the servicing business "on my own account," and I would like to know if any of you chaps would like to start a kind of "Service Data Exchange," relating to tube developments, receiver design and faults, new ideas and hook-ups for quicker and better servicing, and such topics?

It is surprising how many receivers from your country are being used over here and as I am the only Service Man in this district who advertises the fact that American receivers are serviced on the premises, I venture to say that I get 90 per cent of such sets for tube replacements and general repairs.

Unfortunately there is a dearth of service dope on these receivers in this country and, but for *Radio-Craft*, I am afraid I would not know when a new tube or other component was marketed, so please see what can be done about such an exchange as I have mentioned.

By the way, is the ORSMA a purely national association, or is there a foreign membership? I will patiently await someone's reply either by mail or in *Radio-Craft* and hope to be hearing something soon.

Cheerio!, and best of luck to "Radio-Crafters" and ORSMA members.

J. DEMPSEY, JR.,
Waterloo, Liverpool, England.

We are sure there must be some among *Radio-Craft's* readers who would profit by an exchange of data with Mr. Dempsey. This would doubtless be of greatest help to Canadians, since there are probably many British sets used there that Service Men would like to know more about.

The ORSMA is an organization of international scope, and has members in a great many foreign countries, so *Radio-Crafter* Dempsey is most welcome to join.

THE AMERICAN LEAGUE WILL FIGHT "RADIO BOOT-LEGGERS"!

WILL HARRIDGE, president of the American League, has announced at Chicago that his association will not tolerate the presence of radio "bootleggers" in the club's parks, states the N. Y. *Mirror*.

The headman of the Junior circuit revealed plans by which he hopes to keep the radio pirates out of major league parks during the coming, or present, season. On the back of each ticket will be a statement that admission does not include permission to transmit accounts of the game without written permission of the team owners. This paragraph will be printed also on all passes and writers' credentials.

In addition, anyone entering, who carries a suspicious-looking satchel will be continuously shadowed by detectives hired by the management, so that there will be no chance to use possible radio equipment. Writers will be bound to forward play-by-play descriptions to their papers only, and anyone who is unfortunate enough to look like a radio announcer to the park "flatfeet" must show credentials or get the gate!

Please Say That You Saw It in RADIO-CRAFT

Have You Seen the New Magazine?

Jobs & Careers
THE VOCATIONAL DIGEST

Telling you how to go about:

WHEN YOU ARE TACKLING
THE JOB OF FINDING A JOB;
WHEN YOU ARE PLANNING
A CAREER;
WHEN YOU WANT TO BETTER
YOUR POSITION.

The new magazine giving you every month a digest of articles from magazines and newspapers all over the country

HOW AND WHERE TODAY

Alert, resourceful men and women have succeeded, where others, WHO DID NOT KNOW, have failed.

PRESENT-DAY JOB COMPETITION IS INTENSE,
ONLY THE INFORMED MAN OR WOMAN
CAN STAY IN THE RACE AND WIN.

"JOBS & CAREERS" IS YOUR GUIDEBOOK OF OPPORTUNITY.

On all Newsstands 25c

If your dealer cannot supply you, send
a quarter and we will forward
a copy at once.

JOBS & CAREERS

Dept. RC-636

520 North Michigan Avenue Chicago, Illinois.

TYPEWRITER BARGAIN

FREE
HOME TYPING
COURSE

10-DAY
FREE
TRIAL
OFFER



ONLY
10¢
A DAY

BRAND NEW
MODEL No. 5

REMINGTON PORTABLE

● A brand new Remington for only 10¢ a day. An easy, practical Home Typing Course FREE. With it anyone quickly becomes expert on this machine... the most rugged, dependable portable made. Not used or rebuilt. Standard 4-row keyboard. Standard width carriage. Margin release on keyboard. Back spacer. Automatic ribbon reverse. Every essential feature of big office typewriters. Carrying Case FREE. Try it for 10 days without risking a cent. If you don't agree it is the finest portable at any price, return it at our expense. Don't delay. Without obligation, write now.

REMINGTON RAND, INC.,

205 East 42nd Street, Dept. 189-G, New York, N. Y.

To Readers of RADIO-CRAFT

FREE POST CARDS MAY BE HAD
UPON WRITING TO PUBLISHERS

These post cards make it easy to answer advertisements which appear in RADIO-CRAFT, without cutting valuable data which you may wish to save.

Many times manufacturers request you to "clip the coupon" when answering their ads. Often this means destroying part of an article on the reverse page you may need later for reference. Save your RADIO-CRAFT issues complete. If you should ever want to sell bound volumes, or certain copies of RADIO-CRAFT, the resale value of uncut issues is very much higher than that of mutilated ones. So send for a supply of these free post cards and use them in answering all RADIO-CRAFT advertisers.

OPERATING NOTES

(Continued from page 726)

bleeder resistor from the control to "B+" had increased from its rated value of 6,000 ohms, to over 35,000 ohms. Replacement of this bleeder cured the trouble.

Sparton Model 104. This set had only been in use about a month, and although somewhat noisy when received from the factory, eventually became excessively noisy. All parts and tubes checked perfectly. The push-pull A.F. transformer was changed and this cleared up the trouble. The defect in this unit did not show up on my meters.

JAMES H. MILLS

Atwater Kent Model 96. This set came into the shop "dead." A check-up showed an open voltage-dropping resistor in the I.F. plate circuit, and when this was replaced, the set started off, apparently OK. However, after about 20 minutes of operation the volume suddenly dropped about 50 per cent. Snapping the line switch on and off restored normal volume for a short time, but it presently dropped once more, when it was discovered that the volume level was the highest with the local-distance switch in the "local" position. Finally, the set began to cut in and out regardless of the position on the local-distance switch. An intermittently-open condenser was suspected at first, but when everything checked OK in that direction, the A.V.C. circuit came under suspicion. (Incidentally, a cross-examination of the owner at this time brought to light the fact that this erratic operation had begun some time previous and had gradually been getting worse.) The tubes had all been checked and passed when the set came in, but after trying several different 35s in the I.F. sockets and 24s in the A.V.C. socket, a combination was found which operated perfectly. However, the difficulty of finding a new tube of the proper characteristics had convinced me that the trouble would re-appear, so I cast about for a permanent cure. It developed that the 35s when thoroughly heated, drew enough grid current to upset the action of the A.V.C. resistor network, so a very heavy wire-wound resistor was inserted in the heater circuit supplying the I.F. and A.V.C. tubes and adjusted to cut down the heater voltage slightly. The original tubes were then replaced in the set and have been "going strong" for nearly 2 years.

Stewart-Warner Companion—A.C.-D.C. This set came in with the complaint of "excessive hum and lack of sensitivity." The filter condenser block

was removed from the chassis in order to gain access to some resistors which I wished to check and upon turning the set on with the condenser block hanging away from the chassis, the hum was found to be gone. Closer inspection of the condenser block showed that it was moist on the outside, the cardboard container being soaked with some sort of thick liquid, evidently coming from inside. This caused a leakage, as the hum re-appeared the instant the cardboard container touched the chassis! Since a block of this type was not available, a temporary repair was necessary, so I placed a layer of thick waxed paper around the condenser and replaced the block in the chassis. Since that time, I have found that this little kink will save trouble if used when putting in a new condenser block in this set as well as others of the same type. Empire cloth is even more satisfactory than the paper.

Philco Model 38. I have had 2 of these sets with the same trouble, in one case the set being entirely "dead" and in the other, "intermittent operation" being the complaint. In this model the I.F. transformers are wound on wood dowels and small staples are used to anchor the leads to the dowel to prevent them from pulling loose from the fine wire of the coil proper. In these two sets the staples holding the primary leads had been driven into the dowel so far that they cut through the insulation of the wire and at such an angle that the points met within the dowel, thus very effectively shorting the primary—in one case completely and in the other, intermittently. Let it suffice to say that this was rather puzzling at first, since all voltages and currents checked 100 per cent, and if it had not been gone over with a low-range ohmmeter, I believe that first set would have been here yet!

Crosley A.C.-D.C. Forty. The complaint on this set was "excessive hum" and when the set was first turned on, in the shop, it proceeded to justify the complaint. Upon removing the chassis from the cabinet and turning it on once more, the hum disappeared. Inspection of the condenser block revealed a very neat hole punched in by one of the screws which hold the chassis in place in the cabinet. In this model three of the screws are long, while only one is short enough to avoid puncturing the condenser housing. Someone, in replacing the screws, had mixed them up so that one of the long ones was placed in the hole directly under the condenser block where the short one should have gone.

GEORGE ROSS

RADIO PICTORIAL

(Continued from page 730)

transmitter and the meteorological equipment. Left and A below show the tiny case containing the measuring instruments, which actuate the radio transmitter and send a signal that is picked up at the observing station and operates the apparatus at B. The signal is tone modulated, a buzzer-type power supply being used for the free balloon, while the airplane equipment has a conventional modulation system with tone fed to the input. The circuit of the latter is shown at Fig. 1B, while the circuit of the R.F. portion of the balloon transmitter is shown at Fig. 1A.

Research carried on at the Blue Hill Observatory of Harvard University shows that the ultra-high frequencies offer the best possibilities for the work. The free-balloon transmitter works on 5 meters, which is about as high as it is possible to go and still obtain reasonable efficiency with present tubes of very low filament drain. The acorn tubes are not used because their drain is considerably higher than that of the type 30 tubes now employed. With the transmitter depicted at Fig. A using 2 type 30 tubes, and a buzzer transformer power supply, good signal strength was had at a distance of 50 miles, when the unit was tried out in an airplane.

Receivers used on these hands are of the super-regenerative type which are connected to a special amplifier that in turn works the recorder. It should be noted that the signal from the transmitter is used not only to operate the recording mechanism, but also for directive measurements to note and plot the course of the free balloon.

Fig. 1. Schematic circuits of the two units described above.

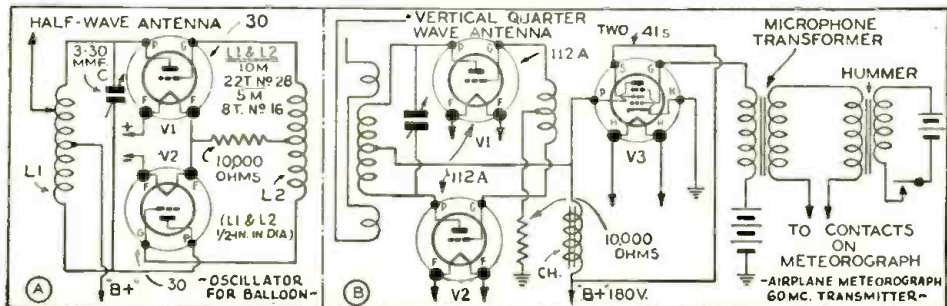

Please Say That You Saw It in RADIO-CRAFT

Again..MIDWEST STARTLES THE RADIO WORLD

with a Marvelous New

4-TUBE FIVE WAVE BAND WORLD-WIDE RADIO

\$39.50 with New Auditorium-Type SPEAKER (1000 TUBES) 30 DAYS FREE TRIAL

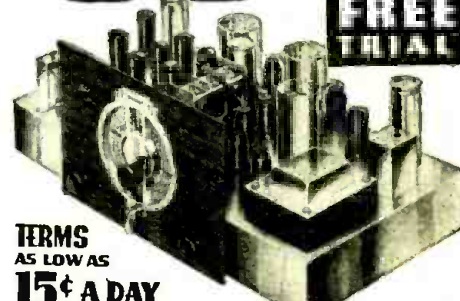

TERMS AS LOW AS 15¢ A DAY

Buy Direct from MIDWEST Laboratories..SAVE UP TO 50%



EVERYWHERE, radio enthusiasts are praising this amazingly beautiful, bigger, better, more powerful, super selective 4-tube 5-band radio. Out-performs \$150 to \$200 radios on a side-by-side test—and will thrill you with its glorious Acousti-Tone, crystal-clear "concert" realism—and magnificent foreign reception. Never before so much radio for so little money! Before you buy any radio, write for the FREE 40-page 1936 catalog.

50 Advanced 1936 Features Scores of marvelous features, many of them exclusive, explain Midwest super performance and thrilling world-wide reception...and prove why nationally known orchestra leaders like Ted Weems, Fred Waring, etc., use Midwest in preference to more costly makes. This advanced 5-band set enables you to switch instantly from American programs to Canadian, police, amateur, airplane and ship broadcasts—to the finest and most fascinating programs from Europe, Asia, Africa, Australia, and South America.

DEAL DIRECT WITH LABORATORIES No middleman's profits to pay—you buy at wholesale price direct from laboratories... saving 30% to 50%. Increasing costs mean higher prices soon. Take advantage of Midwest's sensational values. As little as \$5.00 down puts a Midwest in your home on 30 days free trial. You are triply protected with: Foreign Reception Guarantee, Parts Guarantee, Money-Back Guarantee!

MAIL COUPON TODAY for Free 30-DAY TRIAL OFFER and 40-PAGE FOUR-COLOR Free CATALOG

MIDWEST RADIO CORPORATION Dept. 12N, Cincinnati, Ohio

Without obligation on my part, send me your new FREE catalog and complete details of your liberal 30-day FREE trial offer. This is NOT an order.

Name _____ Address _____ Town _____ State _____

Check if interested in a Midwest All-Wave Battery Radio

THE DESIGN OF MODERN TEST EQUIPMENT

(Continued from page 728)

POLITICS PAYS PROFITS

Sound trucks . . . portable P.A. systems . . . permanent P.A. installations . . . are all in greater demand this year because it is a presidential campaign year!

Political organizations of all parties are going to rent, or purchase outright, various types of public address equipment. Lafayette has prepared a special LIST PRICE catalog to help YOU sell P.A. equipment. And most important of all Lafayette engineers have spent months in the development of new, finer P.A. equipment. Send for your free copy of Lafayette's complete P.A. list price catalog No. 64. Get on the political bandwagon with Lafayette for profits in P.A.!

LAFAYETTE RADIO MFG. CO., INC.
100 SIXTH AVENUE ••• NEW YORK, N. Y.

Dept. LRC-66. Gentlemen:
Send me your P.A. Catalog No. 64

Name

Address

City State

You, too, Can become a RELIABLE SPEED RADIO OPERATOR (LEARN AT HOME)

THE Candler System is the QUICK, EASY way to learn—whether you're a beginner or an amateur. Candler gives you the SHORT CUTS—its simplified system makes it EASY TO LEARN. The Junior Course for beginners—the Advanced Course for HIGH SPEED TELEGRAPHING—gain more speed by following Candler principles of coordination—essential to High Speed Telegraphy. It's like playing a game—with the Candler System you learn scientifically! It teaches you SOUND SENSE quickly—Automatically. You will be astounded at your immediate progress—and marvel at the SPEED and ACCURACY that will soon be yours.

TED McELROY Says
Official Champion Radio Telegraph Operator of the World.
"The Candler System is the quickest, easiest way I know of to become a top-notch Radio Telegraph Operator."

Our FREE BOOK tells you the quickest way to become a FAST, RELIABLE Radio Operator. Don't delay—send for your copy TODAY.

CANDLER SYSTEM CO.
Dept. RC6, Asheville, N. C.

RADIOS..SAVE UP TO 50%

DEAL DIRECT. Factory Prices. Many models to select from: AC-DC All wave, Farm, Car and new Metal Tube Models. Your name and address on postcard brings you NEW 16-page 1936 Bargain Catalog in colors FREE. Get details of 30-day TRIAL plan and Agent-User proposition. **Goldstone Radio Co., Dept. 284** 8780 Grand River, Detroit, Mich.

Free Catalog

30 DAY TRIAL \$6.98

GREATEST OF ALL RADIO HANDBOOKS

Just Out! Almost 400 pages. 1936 "RADIO" HANDBOOK by Frank C. Jones. Tells how to design, build and operate any receiver, transmitter or 5-meter transceiver, from 1 to 12 tubes. Hundreds of new circuits and pictorials. Covers entire amateur and experimental fields. Shipping weight 2 pounds. Sent postpaid in U. S. for \$1.00. Elsewhere \$1.15.

Send orders to: Pacific Radio Pub. Co., P. O. Box 3278, San Francisco, Calif.

illumination is not necessarily directly related to the electron-emitting qualities of the filament or cathode element of the tube. It was soon learned, too, that a tube could be "paralyzed" even though the filament be illuminated as brightly as ever, and still be inoperable because the illuminated filament would no longer emit enough electrons for satisfactory operation. Most tubes of those days were constructed with thoriated filaments, and could be easily "paralyzed" by overload potentials; the real "gyp" artist was the man who could use a monkey-gland "rejuvenator" to "re-activate" his old stock of "paralyzed" tubes, accumulated from hapless customers, and re-sell them as new tubes.

THE "GRID SHIFT" VS. "MUTUAL CONDUCTANCE" TYPE TESTER

After it had become an accepted fact among the more technical members of the radio fraternity that filament illumination was not a true indication of the tube merit, it became necessary to devise some means other than a filament continuity tester to indicate the quality of a radio tube. Before the advent of the use of alternating current for filament (or heater) energy, there were no rectifier tubes, and the very few popular types of tubes were what are technically known as triodes; that is, tubes having three elements known as (1) the filament, (2) the plate, and (3) the control-grid. By establishing the correct values for negative control-grid potentials and for positive plate potentials, the earlier types of general-purpose tubes could be used either as detectors or amplifiers, and it became customary to test these tubes as amplifiers. Since mutual conductance is related to amplification, it became the practice to test amplifier tubes by the well-known "grid shift" method, whereby a small change is made in the negative control-grid potential so as to cause a corresponding change in the plate current, the amount of magnitude of the plate current change being considered as an indication of the mutual conductance of the tube.

Since a small change in negative control-grid potential produces a relatively large change in plate current it is seen that an amplifier tube has a "trigger action," and may be crudely compared to a gun in which the stored up energy in the cartridge represents the filament battery, the trigger represents the grid, and the discharge represents the plate current. Another crude analogy which has been used consists of comparing the function of an amplifier tube to that of the ordinary city fire engine which takes water from low-pressure mains and "steps up" the pressure for the fire hose. The additional power is supplied from the energy stored up in the fuel used in the fire engine which may be compared to the filament battery of stored up electrical energy.

The "grid shift" method of testing tubes is well known as it has been used for several years. It is wrong, however, to refer to a "grid shift" test as being a mutual conductance test, unless rated D.C. potentials are applied to a tube during the test. Any variation from rated D.C. potentials will produce corresponding variations in mutual conductance ratings. This is proved by a casual observation of a table of tube characteristics such as that published by any tube manufacturer. For example, it may be observed that the type 01A tube has a rated mutual conductance value of 725 micromhos when operated with a negative control-grid potential of 4.5 V., and with a positive plate potential of 90 V.; but when the applied negative control-grid potential is 9 V. and the applied positive plate potential is 135 V., the mutual conductance is rated at 800 instead of 725 micromhos.

MUTUAL CONDUCTANCE TESTER

As explained in the preceding paragraph, a true mutual conductance type tester is simply a "grid shift" type in which rated D.C. potentials are applied to the tube under test. Therefore, it will be noted that the change in rated mutual conductance has been effected by changing both control-grid and plate potentials; what would happen if only one of these potentials were changed? It is obvious that any departure from any rated potential will result in a departure from rated mutual conductance, and that a mutual conductance tester which is designed to test tubes by mutual conductance measurements

for comparison with rated values must be so designed as to enable the application of rated D.C. values. When it is remembered that there are almost innumerable combinations of filament (or heater), plate, control-grid, screen-grid, suppressor-grid, exciter-grid, etc., potentials, it is readily appreciated that a mutual conductance tube tester, made up as a single unit, would be quite complicated in its design and operation, and would be too expensive for practical commercial purposes.

Such a tester would require batteries or a D.C. "power pack" with good regulation and designed to supply all the D.C. potentials and currents listed by tube manufacturers, with a control for each tube element, plus one or more controls for the metering circuit. As applied to an 8-element tube, the tester would require about 10 controls, would cost several hundred dollars, and require about an hour to test a set of tubes! Imagine spending 30 minutes, to an hour, to test a customer's tubes to make a 60-cent sale with a profit of 24 cents! How long would it take to pay for such a tester in profits from tube sales?

PRECISION VS. UTILITY

The high cost and operating complications of a true mutual conductance tester have resulted in efforts on the part of testing equipment design engineers to make such compromises in absolute accuracy as are necessary to strike a balance between absolute accuracy and practical utility; such a practical compromise involves (1) a commercially acceptable selling price, (2) a reasonable degree of simplicity of operation, and (3) a practical degree of accuracy. This results in a departure from the use of the various rated D.C. values to a compromise of a few average values which can be applied to all tubes alike, thereby lowering the number of controls and providing the desired element of simplicity of operation, without a serious sacrifice of accuracy, so that the practical Service Man can obtain, at a cost under \$50.00, a simple tester with an accuracy in the order of 90 per cent instead of having to pay several hundred dollars for a more complicated tester with an accuracy of 95 per cent or more; but never 100 per cent (as perfection can only be approached but never attained by human effort).

The "grid shift" tester with its compromise of applied potentials was simple enough until the sudden avalanche of some 150 types of new multiple-element tubes; when the simple "grid shift" tester had to take on a larger number of sockets, or a larger number of controls, or both, with additional compromises with accuracy. It was then that the design engineers began to study the possibilities of other types of testers which could be designed with a more desirable element of operating simplicity, without too much sacrifice of the desirable element of practical accuracy.

OSCILLATOR-OUTPUT METER TESTER

Some of these research efforts were directed towards a design consisting of an R.F. oscillator combined with an output meter, so as to make comparative tests of tubes in operation. This method, however, has not been accepted as having any outstanding merit, because its use requires (1) an operative radio set; (2) is based on the assumption that all new tubes, with which old tubes are to be compared, are perfect and that no new tubes are damaged in transit; and (3) this method is quite deceptive when applied to radio sets in which A.V.C. circuits are involved to compensate for the differences between the tubes which are subjected to the test.

Furthermore, the use of an oscillator and output meter combination for tube testing is restricted almost altogether to shop work, as the average radio owner would not want to listen to the weird noises emitted by the loudspeaker of his radio receiver while the oscillator is connected thereto when the tube testing operations are performed in the customer's home.

EMISSION TESTER

As the result of the practical necessity for eliminating the oscillator-and-output meter combination for general tube testing practices, the emission tester came into favor, because it was found that a well-designed emission tester may be more accurate than a so-called "grid shift" or "power output" tester with compromised

Please Say That You Saw It in RADIO-CRAFT

Westinghouse Power Generator

Manufactured for U. S. Signal Corps

200 Watt. 110 V. AC

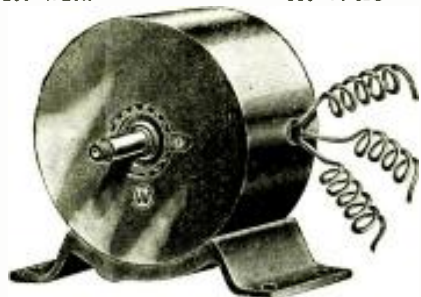

A. C. ELECTRICAL POWER

from a Windmill, from available Waterpower, from your Automobile, from your Motorcycle, from your Bicycle, Foot-pedals or Handcrank (for trans-portable Radio Transmitters, Strong Floodlights, Advertising Signs); do you want to operate AC Radio sets from 32 V. DC farm light systems; operate two generators in series to get 200 V. AC; obtain two phase and three phase AC, etc., etc.

There Are Over 25 Applications

Some of which are:

A.C. Dynamo Lighting from eight to ten 20 Watt 110 Volt lamps. Short Wave Transmitter supplying 110 Volts AC for operating "Ham" transmitter. Operating 110 V. AC 60 Cycle Radio Receiver in DC districts. Motor Generator. Public Address Systems. Electric Sirens on motor boats, yachts, etc. Camp Lighting. Short Wave artificial "fever" apparatus. Television. Pelton Waterwheel for lighting or other purposes. Airplane: for lighting strong search lights or electric signs. Laboratory work, etc., etc.

1/4 to 1/2 H.P. needed to run generator.
BLUE-PRINT 22 x 28 In. and Four-Page 8 1/2 x 12 in. INSTRUCTION SHEETS FREE with Generator.

Generator, as described, including four replacement carbon brushes. Blue-print and instructions **\$7.90**

Send \$2.00 deposit balance C.O.D. Shipping weight 18 lbs.

(Replacement carbon brushes bought separate \$1.50 per set of four. Set of instructions bought separate \$1.00.)
MONEY-BACK GUARANTEE

WELLWORTH TRADING COMPANY

560 West Washington Blvd., Dept. RC636, Chicago, Illinois

THIS MAGAZINE NEEDS NO INTRODUCTION TO SHORT-WAVE FANS

SHORT WAVE CRAFT

This popular monthly magazine, SHORT WAVE CRAFT, contains everything you want to know about Short Waves. The wonders of world wide short-wave reception are clearly described and illustrated. Latest practical information for radio fans, experimenters and "hams" will be found. Tells you how to build short-wave receivers and transmitters; construct sets of one and two tubes or as many as seven, eight or more. Tells best foreign stations to log and when to tune them—includes newest and best circuits of the time. SHORT WAVE CRAFT is edited by Hugo Gernsback.

NEW FEATURE RECENTLY ADDED—To the short wave fan who has logged and obtained verification of the largest number of short-wave stations from all over the world during one month, will be awarded a magnificent 24" silver trophy.

Special This Month Only!

For this month only, we offer readers of this magazine the opportunity to read radio's greatest short-wave magazine at a special saving. The regular subscription price is \$2.50 per year. You can now get SHORT WAVE CRAFT for the next

8 MONTHS FOR \$1.00

4-Color Cover
 Over 200 illustrations
 9x12 inches in size

25c The Copy
 ON ALL NEWSSTANDS



Send remittance by check, money order or U.S. Postage Stamps. Register letter if it contains cash or currency.

SHORT WAVE CRAFT

99R Hudson Street New York, N. Y.

potentials and controls. After all, about all that can happen to a radio tube, within the realm of probability, after the tube is placed in service, is a depreciation of the emitting qualities of the cathode element, so why not test a tube by measuring the emission current?

There are other possible causes of tube failure, of course, such as lightning strokes, air leakage through the glass envelopes, etc., but we are speaking of probabilities and not of extremely unlikely possibilities, so that it is quite practical to conclude that an amplifier tube loses its mutual conductance in service by reason of a lowering of the emission incidental to the prolonged service; in other words, all tubes, amplifiers and rectifiers, depreciate with a loss of emission, and a measure of the emission of an amplifier tube is a measure of its operating merit, just as a measure of the emission of a rectifier tube is a measure of its operating merit.

Having arrived at the conclusion, then, that a well-designed emission tester is as reliable as a "grid shift" tester and having confirmed the accuracy of this conclusion by laboratory comparisons of the two types of testers, we are ready to study the details involved in a well-designed emission tester circuit.

DESIGN OF EMISSION TESTER

For the purpose of analyzing the factors involved in the design of a tube tester of this type it is convenient to resolve tube characteristics into "equivalent resistance values"; because, under a given set of conditions a particular tube will act as a resistance (except that it will pass current in only one direction). In order to better understand the resistive characteristics of tubes, let's refer to Fig. 6A which represents a type 01A tube with varying positive potentials applied to all of the elements, except the cathode, connected together so as to attract practically all of the electrons emitted by the cathode. Curve A represents potential and current values of a new tube, while curve B represents the same tube after it has been depreciated.

Now observe that any one of the potential values taken horizontally from curve A and divided by the corresponding current value, taken vertically from the same curve, will indicate the resistance value of the tube under the particular load conditions. It is seen that, with an applied potential of 18 V., the current load on curve A is 17.8 ma., from which we derive, by Ohm's Law, a resistance value of 101 ohms. Similarly, with 18 V. on curve B, the current load is 11.8 ma., from which we derive a resistance value of 152.5 ohms. We can determine the percentage of depreciation at 18 V. by subtracting 11.8 ma. from 17.8 ma., and dividing the difference by 17.8 or by subtracting 101 ohms from 152.5 ohms and dividing the difference by 152.5; in either case, the tube depreciation from curve A to curve B is found to be about 34 per cent at 18 V. Accordingly, curve A can be said to represent (a) the resistance of a normal tube and curve B can be said to represent (b) the resistance value of the tube after its emission has depreciated.

A further consideration of the factors presented in the last paragraph leads us to conclude that our tube-testing circuit should be capable of indicating the load changes which are directly related to the changes in effective internal resistance value of tubes as they depreciate in emitting quality so that, when the rated load of a normal tube is indicated in the "GOOD" sector of a meter scale, such as that shown in Fig. 6B, the reduced load resulting from depreciation of the same tube to a degree beyond satisfactory operation will be indicated in the "BAD" or "???" sector of the meter scale.

Since a potential value of 30 V. has been generally held as a satisfactory value to be applied between the cathode and all other elements of all tubes to produce an approximate normal load for each tube, it is necessary (when using this fixed potential value for all tubes) to provide some means for varying the indicating range of the meter to cover all normal loads which may be expected of the different types of radio tubes which the tester will be required to accommodate. The most simple circuit for accomplishing such results is that indicated in Fig. 6C. Since current will pass through the tube only in the direction of the arrow in Fig. 6C, one end of the secondary winding is indicated as being negative and the other end is indicated as positive, and it will be observed that the indicating range of the meter may be controlled over a wide range of load values, determined only by the basic sensi-



Worth Many Times Its Price!

\$13.95

Complete and GUARANTEED

DEPENDABLE "RCP" MULTITESTER

Designed for accurate and speedy service. 2000 ohms per volt sensitivity. 3 range ohmmeter, 1/2 ohm to 3 million ohms, 4 range voltmeter, micro-ammeter and milliammeter. Complete with self contained batteries. Kit \$10.65. Order from your jobber.

"DEPENDABLE" TUBE and SET TESTER

Tests all tubes as well as shorts and leakages, also all types of condensers. Makes capacity and ohmmeter tests. 5" full view fan-type "Good-Bad" meter, separate line voltage meter, neon indicating lamp. A double duty instrument at a remarkably low cost.



Ready-to-Use **\$21.95**
 KIT: \$17.85

NEW! Mail coupon below at once for bulletin on sensational new Dependable Analyzer coming soon! Don't miss it!

RADIO CITY PRODUCTS CO. 88 Park Place, New York City

Please rush me your bulletin describing the NEW Dependable Analyzer.

Name
 Address

Your FREE COPY



SPORTING GOODS
WATCHES-CLOCKS
TYPEWRITERS
OPTICAL GOODS
CAMERAS-NOVELTIES
ELECTRICAL APPLIANCES, ETC.



is JUST OFF the PRESS

Contains hundreds of up-to-the-minute bargains, specials at PRICES THAT ARE SLASHED TO THE BONE! "Save Money on Everything you Buy"—Send for your FREE COPY of this big new book—join the thousands of satisfied customers all over the world who rely on "BARGAIN BULLETIN" for TREMENDOUS CASH SAVINGS. This Catalog is ABSOLUTELY FREE—without any obligation. Just send us your name and address—a postcard will do.

RADIO CIRCULAR CO., INC.
 915 Broadway, Dept. R.C., New York, N. Y.

Please Say That You Saw It in RADIO-CRAFT

So Handy!

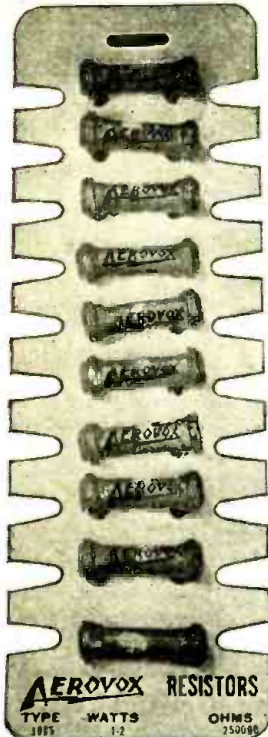

Those **AEROVOX** Carbon Resistors—best money can buy—come in handy boxes of 10 on display card.

Units R.M.A. Color-Coded and stamped with resistance values.

Ratings of 1/3, 1/2 and 1 watt. All resistances.

Pigtail leads can't work loose or come off.

Designed for "stayput" jobs.

Cheapest in the long run.

Write . . .

New catalog on request. Also sample copy of Research Worker.

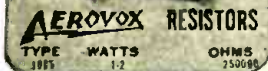

77 Washington St. : : Brooklyn, N. Y.



ANNOUNCEMENT!

Time Payments
Now Available on

CLOUGH-BRENGLE Instruments

For as little as 33c per day you can completely modernize your shop on the new C-B "Pay-As-You-Earn" Plan. Ask your jobber or write for new booklet.

The CLOUGH-BRENGLE CO.

1134-X W. Austin Ave., Chicago, U. S. A.

DEALERS!

NEW SUPPRESSORLESS ALL METAL TUBE AUTO RADIO

6-tube superheterodyne-low battery drain—uses new metal 0Z4 filament-less rectifier tube—iron core antenna coil—sensitivity control—single bolt mounting, steering column and special dash controls for latest cars—Send for free catalog describing this and other outstanding models for home, farm and auto.

MODERN RADIO & TELEVISION CO.
DEPT. 11
5154 N. CLARK ST., CHICAGO, ILLINOIS

RAYTHEON

TRADE MARK

RADIO RECEIVING TUBES

Write for **FREE 1936 Tube Chart**
RAYTHEON PRODUCTION CORP., Dept. E-6,
30 East 42nd St., New York, N. Y.

THE DESIGN OF MODERN TEST EQUIPMENT

(Continued from page 757)

tivity of the meter and by the resistance value of the rheostat. R. If a meter having a full-scale load value of 10 ma. (0.010-A.) with an internal resistance value of 10 ohms be used with a 100-ohm shunting rheostat, the indicating range of the meter would be controllable for any ordinary load value above 11 ma. While the resultant measuring range would be inadequate for the requirements of a modern tube tester, the values indicated will serve the present purpose of discussing the design features of tube testers.

Referring again to Fig. 6C, let's observe what might happen if a tube with elements shorted to one another were placed in the test circuit. Such a "short-circuited" tube would have zero resistance, so that the only appreciable resistance remaining in the circuit would be that of the meter, across which the total circuit potential value of 30 V. would develop. The normal full-scale potential drop across the meter is 100 millivolts (0.1-V.), obtained by multiplying the full-scale current load of the meter by the resistance value of the meter. Therefore, a 30-V. potential value developed, because of a short-circuited tube, across a 0.1-V. meter would impose upon the meter a load which is about 300 times that which the meter is designed to normally register. With such an overload, what would happen? It would be "good-bye" meter! And if the meter were to stay intact, then the transformer would soon pass out of the picture. This contingency suggests, then, that some means must be provided to protect the meter and transformer against short-circuited tubes. A fuse is a logical suggestion, but a burned-out fuse is an invitation to some people to use a brass lug or a bridging wire when a new fuse is not immediately available, so that the necessity for protecting the circuit with a fuse should be eliminated if such elimination be practicable.

(Part IV of this series will conclude the consideration of tube testers, explaining how the problem of meter mortality is overcome; and will supply a commercially practical circuit.—Editor.)

This article has been prepared from data supplied by courtesy of Supreme Instruments Corp.

ANTENNA DIRECTIONAL PROPERTIES CHECKED BY USE OF YACHT

ENGINEERS of the Zenith Radio Corp. recently made tests to check the directional properties of the doublet type antenna used by many short-wave fans. The tests were made on the 190 ft. yacht, "Mizpah," owned by Commander E. F. McDonald, President of Zenith.

This yacht is equipped with twin engines and propellers, so that it can be turned about in almost its own length. A standard doublet consisting of 2 30 ft. lengths of wire with a transmission line tapped in at the center, was erected between the masts of the ship. A 7-tube receiver was used and a meter was placed in the plate circuit of one of the I.F. tubes, so that it would vary with signal strength due to the action of the A.V.C. The meter was calibrated directly in microvolts to the receiver.

With this antenna rig, the ship was rotated slowly through a complete circle. The receiver was tuned to station DJC in Germany, and when the ship was turned so that the direction of the doublet was at right angles to the direction of the signals, the meter read about 250 microvolts input. With the doublet pointing directly at the station, the input dropped to 50 microvolts. Several additional checks were made to be sure of the accuracy of the results. An identical test was then made with the regular ship's antenna, which showed very little directional properties.

The large variation in input to the receiver with the doublet showed that the latter could be used in an emergency as a ship's direction finder.

The check was made on the ship because it was convenient to turn the antenna and make the complete test in the space of a few minutes, while if it had been made on land, a much longer time would have been taken to shift direction, with the result that atmospheric conditions would have had to be taken into account.

Please Say That You Saw It in RADIO-CRAFT

SPECIAL OFFER Complete Public Address System

AS ILLUSTRATED
Immediate Service

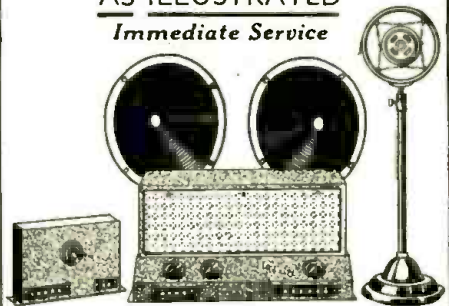

20 WATTS

YOUR PRICE

\$59.90

less Tubes

Here's what you get:

- 1—20-Watt High-Gain 6B5 Push-Pull Amplifier using 1—6AB, 2—76's, 2—615's and 1—5Z3. Input to grid of first tube. Output to 2-4-8-15 ohm voice coils and 500 ohm line. Power consumption 85 watts. For use on 115 volts, 60 cycles. A.C. Can be used with velocity mike.
 - 2—12 1/2" A.C. Dynamic Speakers matched to amplifier.
 - 1—Fader Mixer Input Box for carbon microphone.
 - 1—72" Adjustable Floor Stand, chromium plated stem, black crystalline base.
 - 1—High Quality Double Button Carbon Microphone. All necessary connecting Plugs and Cables.
- All components are perfectly matched to each other. Ship. wt. of Complete System, 75 lbs. Ship. wt., Amplifier Alone, 33 lbs.
- Complete Set of Matched Tubes\$7.00
\$5.00 extra complete system with velocity mike.

5-WATT AMPLIFIER

No. R-2B6A

\$8.70

less Tubes

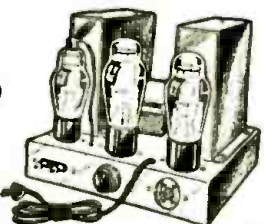

Gain 85 d.b. Input 250,000 ohms to grid of 5Z3. Output for 5000 ohm output transformer primary. Tubes: 1—5Z3, 1—2116, 1—5Z3. Consumes 50 watts. Operates on 115 volts, 60 cycles. A.C. Size: 8 1/2" x 6" x 7 1/2". Provides field current for 1—1500 ohm speaker or 2—3000 ohm speakers in parallel. Ship. wt., 15 lbs.

100% Satisfaction Guaranteed. Send Money Order or certified check. C.O.D. shipments require a 20% deposit. Immediate Service—No Waiting.

HUDSON SPECIALTIES CO.

40 West Broadway

New York City

CLASSIFIED ADVERTISEMENTS

Advertisements in this section are inserted at the cost of twelve cents per word for each insertion—name, initials and address each count as one word. Cash should accompany all classified advertisements unless placed by a recognized advertising agency. No less than ten words are accepted. Advertising for the July, 1936, issue should be received not later than May 7, 1936.

A.C. AUTO GENERATORS

TURN SCRAP INTO MONEY. AUTOPOWER SHOWS you how easily and economically auto generators can be converted into A. C. or D. C. generators and D. C. motors. 2 to 1000 volts; for sound, radio, power, light, or welding. No previous experience necessary—complete information all in new book, with simple instructions and illustrations. Endorsed by thousands. Only \$1.00 postpaid. Autopower, Inc., 414-C S. Hoyne Ave., Chicago.

RADIO

RADIO ENGINEERING, BROADCASTING, AVIATION and police radio, servicing, Marine and Morse Telegraphy taught thoroughly. All expenses low. Catalog free. Dodge's Institute, Pine Street, Valparaiso, Indiana.

FIXED RADIO DETECTOR—THIS DETECTOR ELIMINATES continual adjustment, that was necessary with the crystal detector, without a loss in sensitivity. Its construction is rugged and compact—the size is 1/2" in diameter by 2" long, with two connections. Price 49c. Radio Research Labs., 920 Moltke Ave., Scranton, Penna.

NEW DEVELOPMENTS IN 7-METER POLICE RADIO

(Continued from page 731)

normal of economic conditions and the opening up of additional frequencies, purchases of police radio systems began anew some 24 months ago and have continued with increasing momentum, particularly during the past year.

300 MUNICIPALITIES ARE POLICE-RADIO EQUIPPED—BUT 16,000 ARE NOT EQUIPPED!

Equipment is now available which amply meets police requirements; whereas some of the earlier apparatus was noticeably subject to shortcomings. In particular, the opening up of ultra-high frequencies by the F.C.C. has made it possible to provide the much needed 2-way feature. Despite recent police activity, a resumé of the authorizations granted by the F.C.C. shows that there are only about 300 United States municipalities now making use of this service. Some idea of the potential market may be gained by reference to Table I, which shows the proportion in which over 16,000 municipalities are populated.

TABLE I

Population	Number of Municipalities
Under 2,500	13,433
2,500 to 5,000	1,332
5,000 to 10,000	851
10,000 to 25,000	606
25,000 to 50,000	185
50,000 to 100,000	98
100,000 to 200,000	52
200,000 to 300,000	16
Above 300,000	23
	16,596

It seems very likely, therefore, that we may now be on the threshold of an era that will witness a remarkable advance in the development and use of radio in the various phases of police activity.

It follows, of course, that the opening up of a new radio field is beneficial to equipment manufacturers, radio operators and Service Men alike. Every police radio installation demands one or more properly licensed operators and a set-up for the servicing of the equipment. In some instances the necessary personnel for performing these duties is recruited from the ranks of the police department; on the other hand it is often necessary to employ outside individuals who are properly qualified.

It is undoubtedly true that the constantly increasing use of radio as an adjunct to police operations will afford prospective employment to numerous individuals outside the regular police ranks. This is particularly true since the design of police radio apparatus usually differs from that encountered in the broadcast and entertainment field, thereby rendering it more or less unfamiliar to the average police officer who may attempt to qualify as an operator or Service Man.

For some time the Federal Communications Commission has been allocating the frequencies of 30.1, 33.1, 37.1 and 40.1 mc. to police organizations on an experimental basis. While only 4 frequencies have been specifically set aside, it follows that a large number of stations may be assigned the same frequency without experiencing a great amount of interference due to the quasi-optical propagation characteristics of these frequencies. Undoubtedly, additional frequencies will be made available in the future, some of which may be higher than any now in use. These factors, together with others that may be mentioned, tend to confirm the belief that "2-way" systems involving the use of high frequencies are almost certain to meet with increasing popularity.

Fig. 1. The super-regenerative detector and noise suppression circuit of the police ultra-high frequency car receiver.

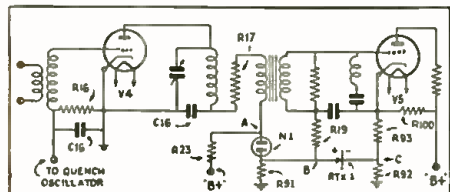

A 7- TO 10-METER POLICE RADIO SYSTEM

Figure A shows a 75- to 150-W, 30- to 42-mc. headquarters transmitter. One of these units was recently installed at Hamilton, Ohio. This installation affords duplex operation and, consequently, antennas for simultaneous transmission and reception are provided at headquarters. This arrangement of aerials is shown in Fig. B. A new 15-W. mobile transmitter designed for mounting in a standard automobile trunk compartment is illustrated in Fig. C. The dynamotor is placed in the same compartment with the transmitter while the control unit may be mounted on the dash. Through the use of a type 47 speech amplifier, two type 46 tubes as a class B modulator and two type 2A3 tubes as master oscillator and power amplifier, respectively, it has been possible to obtain a 15-W. output at a tube cost approximating 1/10th of that for previous similar equipment!

The receiver is designed for mobile (Fig. C), headquarters, and precinct installations. It is unique in that it incorporates a superheterodyne circuit with the added feature of super-regeneration in the second-detector.

For quite some time radio engineers have known that both the superheterodyne and super-regenerative principles of reception possess some very desirable electrical characteristics; however, neither principle in itself appeared to afford all that was desirable in a receiver for police service. For example, the usual superheterodyne affords excellent selectivity, but is lacking in sensitivity and A.V.C. action and, also, will not quench the electrical interference that may be present during reception of the desired signal; on the other hand, the super-regenerative detector has poor selectivity and is a source of objectionable radiation, yet it possesses high sensitivity, inherent A.V.C. action that is extremely rapid and will effectively quench electrical disturbances. Through the use of a superheterodyne circuit with super-regeneration in the second-detector, the G. E. Co. has produced a receiver that incorporates all the salient features of both superheterodyne and super-regenerative action—plus "carrier off" noise suppression. A schematic diagram of the super-regenerative detector and noise suppression portions of this circuit is shown by Fig. 1. A compact, crystal-controlled frequency monitor (Fig. D) has been designed primarily for use by police organizations. The low temperature-frequency coefficient type of quartz crystal is used with the result that an accuracy of 0.02-per cent is obtained without the need for temperature control. This unit is completely A.C. operated and a flexible lead is provided for connection to any convenient outlet.

This article has been prepared from data supplied by courtesy of General Electric Co.

INSTALLING INDOOR AND OUTDOOR P.A. SYSTEMS

(Continued from page 727)

the volume just great enough for good audibility as the acoustical conditions change. A certain hall which may be used for a dance one night and public speaking another night would require an amplifier of greater power than if the hall was used for public speaking only. (Keep this point in mind when you go into your sales patter.)

This article has been prepared from data supplied by courtesy of Coyne Electrical School.

THE RADIO MONTH IN REVIEW

(Continued from page 711)

made a statement in Kansas City, last month, that Warner Brothers would establish a coast-to-coast broadcasting chain—to form an outlet for its motion picture talent and also to popularize the songs it controls. We wonder if Warner Brothers is feeling the drop in popularity of their music because of the lack of radio dissemination!

Please Say That You Saw It in RADIO-CRAFT



RCA SPIDERWEB ANTENNA CATCHES ALL SIGNALS

12 to 2100 and 4 to 2100 meters

Here is the first truly all-wave antenna, multiple-tuned to all bands, with built-in coupling transformer that automatically selects the proper segments for the desired band. Provides a tremendously increased signal to the receiver, reduces noise on all short wave bands, and brings in stations you have never heard before.

The RCA Spiderweb Antenna comes complete, all connections soldered, ready to erect. Requires a span of only 38 feet, clearance of 12 feet. Stock No. 9685, 12 to 2100 meters, \$8.95. Kit Stock No. 9689, extending range to 4 meters, making 5 antennas in 1, \$1.50. Write for details.



SPIDERWEB ANTENNA
RCA Parts Division

RCA MANUFACTURING CO., INC.
Camden, N.J. A Service of the
Radio Corporation of America

Here At Last Universal OCTAL ADAPTER For ALL Octal Sockets

LOSE NO MORE TIME IN ANALYZING SETS WITH BLANKED OUT OCTAL SOCKETS.

— SENSATION OF SEASON —



Pat. Pending
AN Analyzer Adapter designed to make possible testing of radio sets, having blanked and unblanked sockets with only one (universal) adapter.

NO MORE DRILLING OF SOCKETS
NO MORE FISHING FOR ADAPTERS
PRICE—\$3.50—NET

Write For DESCRIPTIVE PAMPHLET
HAYWARD RADIO & ELECTRIC
HAYWARD WISCONSIN

FREE!

Complete data on a new series of Broadcast-Quality, High-Fidelity, High-Gain, and High-Power Amplifiers

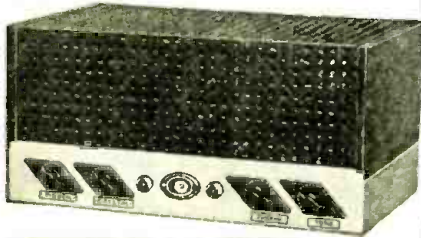

DESIGNED BY A. C. SHANEY

Incorporate such revolutionary features as:

- Automatic Feedback Suppression
- New 6L6 60 Watt Amplifiers
- Volume Level Expander
- Automatic Tube Noise Suppression
- Tandem Class "A" and Class "B" Audio
- Cathode Ray Control Indicator
- Automatic Audio Volume Control

Our Amazingly Low Prices, FREE TRIAL OFFER, and FIVE YEAR GUARANTEE Make it Worth Your While to Write for Free Circular No. PA 536.

AMPLIFIER Co. of AMERICA
20 West 22nd St., New York, N. Y.

QUALITY recommends

Condensers

by

WET ... DRY
PAPER
MICA ... TRIMMER



Please Write for Details

SOLAR MFG. CORP. 599-601 Broadway
New York City

6 VOLT and 110 VOLT

A. C. AMPLIFIERS

SPECIAL OFFER: 50 Watt Dual Channel 110 volts A.C. model 500-15-8-4-2 Ohms Output, 2 Channel InPut Mixer, Hi-&-Lo Equalizer, complete with \$40 Ribbon or \$37.50 Crystal Mike, two Roia G-12 A.C. Speakers, Crystal Pick-up. **\$89.00** Special offer for the entire system

COLUMBIA SOUND CO., Inc.
135 Liberty Street New York



30-13,000 CYCLES ± 1 D. B.
MULTIPLE COIL
Hum Free Construction
List: Each
Audio Transformers \$6.25
In Hum-Proof Cases

Midket A.F. Transformers and Chokes
1 1/2 x 1 1/2 x 3/4 inches List \$3.00
Hum Proof Alloy Case, No. 1
and No. 2 List \$1.00

ALLOY TRANSFORMER CO., Inc., 135R Liberty St., N. Y. City

Correspondence Courses in RADIO and ELECTRICAL ENGINEERING

ELECTRICAL ENGINEERING covers complete electrical field. Most modern course. So simplified anyone can grasp quickly. **LOW COST**

RADIO ENGINEERING Ultra-modern course in radio, public address photo-electric work. Trains you to be super-service man, real vacuum tube technician. Diplomas given. Tuition only \$25, other course. Deferred payment plan. **WRITE TODAY** for free copies of school catalogs, student magazines, etc. **SEND NOW!**

LINCOLN ENGINEERING SCHOOL
859-H So. 37th St., Lincoln, Nebr.

BOOK TELLS ALL!

MODERN RADIO SERVICING

Get Free Circular Now

RADIO & TECHNICAL PUBL. CO.
45 Astor Place, N.Y. C., Dept. RC66

MAKING A PRECISION ALIGNING UNIT

(Continued from page 732)

absent.

Another effect resulting by the zero beat method is readily determined by the behavior of the meter in the rectifier circuit (modulator). The degree of difference between the two frequencies (increasing instability of the signal generator) is shown by the slow and periodical movement of the meter indicator. If the frequency variation is 200 cycles at, for instance, 1,000,000 cycles, then the accuracy is 0.02-per cent; at 400,000 cycles it is 0.05-per cent. The best precision oscillator does not exceed 0.05-per cent.

Of the various methods that are used to obtain frequency stability, the so-called "grid-leak and condenser" method is the most economical and its efficiency is relatively high.

A SELF-STABILIZING CIRCUIT

As Fig. 1B indicates, gridleak R, and grid condenser C, are used in an oscillating circuit. The negative charges accumulating on the grid of the tube are being dissipated by the grid leak while the grid condenser is blocking the successive charge. The action of charging and discharging, sets up a polarized potential across the gridleak. The voltage thus set up is the bias voltage for the tube. This bias would be fixed in value if the oscillator was to be tuned to a single frequency, but, if it is to cover the radio frequency spectrum, then the bias would no longer be constant. The reason is given in a few words: the voltage set up across the gridleak and used as a "stabilizer" in an oscillator circuit, is variable according to the amplitude of oscillations, and this amplitude is greatest at the higher-frequency end of any given band.

The gridleak voltage "stabilizing" effect mentioned above arises from the tendency of the leak to maintain a steady amplitude by changing the bias in pace with that of the oscillation voltage. As the amplitude of oscillations rises at the higher-frequency end of the band, greater grid current will flow, developing an increase of grid bias and thereby reducing the amplification; at the lower-frequency end the effect is reversed.

The proper choice of the gridleak and condenser depends upon the average grid current, the plate voltage and the coupling feedback.

Thus, in circuits that tend to be unstable (due to the "rising characteristic"—that is, an increase of feedback with frequency increase) the leak will serve as a balancer or a governor; and, due to its relay action, a tendency toward amplitude stability can be reached.

Besides the stability effect of the gridleak and grid condenser, this combination is also capable of generating a secondary frequency.

"GRID LEAK AND GRID CONDENSER" MODULATION

Since the radio frequency current applied to the grid of the tube has to detour the gridleak, a condenser of such a value as to make the obstruction low, is put across the resistor. If the gridleak and condenser values are high enough, an additional or secondary frequency of oscillation will be generated of a value equal to the reciprocal of the leak and the condenser time constant. The resultant frequency may then fall within the audio range and thus serve as a modulation frequency.

This method of modulation is not acceptable if efficiency is to be considered, as the amplitude level is not constant. Thus it becomes difficult to obtain resonance with a fair degree of accuracy upon a resonance indicator.

Separate modulation generally consists of a source of A.F. current enclosed in the same unit. The source can be derived from a V.T. audio oscillator, neon oscillator or other methods.

In external modulation the voltage can be procured from almost any source whose frequency is in the audio frequency range. Few of the many sources are: a fixed or variable audio frequency oscillator, beat note oscillator, phono, records, mike, etc.

Having a stabilized R.F. current and an A.F. current, we wish to know the relationship between the two frequencies; or, rather, the difference between the carrier amplitude current and that of the modulating current, which is better known as "percentage of modulation."

PERCENTAGE OF MODULATION

This factor is measured as: the ratio of half the difference between maximum and minimum amplitudes, to the average amplitude of a modulating wave. The average amplitude is the unmodulated carrier. The fraction found is multiplied by 100 to change it to percentage.

Another method is

$$\%M = \frac{Em - Im}{E} \text{ or } \%M = \frac{Im - Em}{I}$$

where Em or Im is the difference between the modulated and the unmodulated R.F. voltage or current, respectively, and E or I is the carrier frequency voltage or current, alone. The resultant is also the percentage of modulation for a single A.F. modulating note. For multiple-frequency modulation (sound), the percentage of modulation is the average of various modulation percentage measurements taken at various frequencies.

This signal generator is a miniature transmitter and a versatile instrument, as it not only supplies a signal of any frequency within one of the 6 bands as outlined in Table I, but many other tests as well.

TABLE I

Features of the Aligning Unit

1. Band No. 1: 100-300 kc.; band No. 2: 300-900 kc.; band No. 3: 900-2,700 kc.; band No. 4: 2,500-7,500 kc.; band No. 5: 7,500-22,500 kc.; band No. 6: 22,000-60,000 kc.
2. An R.F. ratio of 3 to 1 is kept throughout the 6 bands; thus the average frequency stability of the 6 bands as indicated on the scale is practically uniform.
3. The oscillator current is modulated by a separate A.F. current generated by a variable A.F. oscillator.
4. Unmodulated R.F. current.
5. Variable percentage of modulation from 0 to 50 per cent.
6. Variable output from an infinitesimal value to maximum.
7. Variable A.F. oscillator, covering 25 to 7,500 cycles.
8. Variable A.F. current output.
9. External modulation with a variable input.
10. Separate control of individual units; each unit can be operated separately with ease.
11. Dual-impedance type dummy antenna.
12. Special adapters.
13. Thoroughly shielded and filtered.
14. Vacuum tube voltmeter, covering 50 to 250 V.
15. A.C. operated.

DESIGN CONSIDERATIONS

The signal generator being A.C. operated uses a type 56 tube as rectifier with its associated filters. A 2A7 tube is used as the generator of the carrier, or oscillator and modulator; a type 58 is the A.F. oscillator and a type 56 is used in a V.T. voltmeter circuit.

The R.F. oscillator is the triode of the 2A7 and the generated frequency is covered in 6 bands which are variable in a 3 to 1 ratio. For the first 3 bands, the inductances used are of the honeycomb type, and the last 3 are of the solenoid, single-layer type. All the oscillator components are enclosed in a heavy aluminum shield, totally separated from other circuits and thus are free from stray radiation or intercoupling between circuits. The tuning assembly or the R.F. oscillator components are the 6 inductances and trimmers, L4-C6, L5-C7, L6-C8, L7-C9, L8-C10, L9-C11, tuning condenser C1, band switch Sw.2, and Sw.3, L3, C4. The 4P-6T band switch Sw.2, totally disconnects the unused coils, thus avoiding absorption or leakage which would tend to introduce instability. Wires to and from the oscillator assembly are shielded with a low-capacity metal sleeve.

The pentagrid tubes were primarily designed for mixing two currents, to form another, by the use of electrons as the coupling medium instead of the more usual method that depends upon capacitive or inductive coupling. Therefore, having used the triode section as the oscillator we will use the pentode section as the modulator. The modulating frequency, whether derived from a separate or external source, is applied at the control-grid of the modulator. The

Please Say That You Saw It in RADIO-CRAFT

GET YOUR COPY NOW!

VOLUME TWO
of the Official
REFRIGERATION SERVICE MANUAL

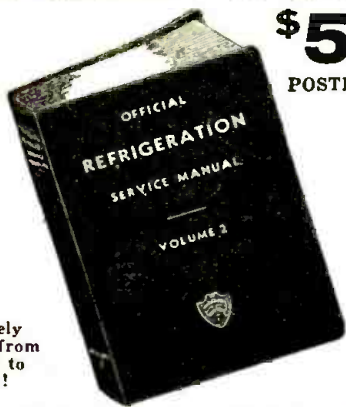

\$5.00
POSTPAID

Entirely New from Cover to Cover!

The Only Complete Refrigeration Service Manual Ever Published

The new volume of the OFFICIAL REFRIGERATION SERVICE MANUAL (Volume II) contains entirely new service data and information of value to everyone interested in refrigeration.

This Manual forms a companion and supplement to the previous OFFICIAL REFRIGERATION SERVICE MANUAL (Volume I), since all data in the 1935 volume are entirely new.

The curve of sales of refrigerators and replacement parts has steadily increased year by year—even during depression years. It is the one industry to make this progress. Year by year sales increases will soon place refrigeration in rank with the automobile industry in importance.

Partial Contents in Second Volume of "Official Refrigeration Service Manual"

- Theory and Fundamental Laws
- Methods of Refrigeration
- Refrigerants, Lubricants and Brines
- Handling and Storage of Refrigerants
- Compression System of Refrigeration
- Liquid Throttle Devices
- Refrigeration Systems
- Electric Control Devices
- Compressors, Types, Seals, Valves, Capacities
- Evaporators and Cooling Units
- Service Tools
- Commercial Unit Specifications
- Servicing Refrigeration Apparatus
- Servicing Low Side Float Valve Systems
- Servicing High Side Float Valve Systems
- Servicing Expansion Valve Systems
- Servicing Thermostatic Valve Systems
- Servicing Restrictor and Capillary Tube Systems
- Charging Systems with Refrigerant
- Electrical Services: Motors, Fuses, Hookups
- Estimating Refrigeration Loads

OVER 350 PAGES
OVER 300 DIAGRAMS

Flexible, Looseleaf Leatherette Binder

This New Refrigeration Manual is printed on a special Bible stock. This stock, although unusually thin, is exceptionally strong and durable. It makes handling of the book much easier.

GERNSBACK PUBLICATIONS, INC.
99 HUDSON STREET, NEW YORK, N. Y.

MAIL COUPON TODAY

GERNSBACK PUBLICATIONS, Inc. RC-636
99 Hudson Street, New York, N. Y.

Gentlemen—Enclosed you will find my remittance of \$5.00, for which send me one copy of the OFFICIAL REFRIGERATION SERVICE MANUAL (Volume II). I understand that this book is to be shipped to me POSTAGE PREPAID.

Name

Address

City State

OVERSEAS READERS!

This book can be obtained from
POWER CONTRACTS, Ltd.
138 Southwark St., London, S.E.1, England

choice of separate or external modulation can be had by the change-over switch Sw.7.

The amount of modulating current superimposed upon the carrier amplitude is variable, where, for separate modulation R10 varies the output current of the A.F. oscillator and for external modulation R13 varies the input of the modulator. Resistor R13 is either a high impedance, or a high-resistance potentiometer with a coupling condenser to the external modulation tip-jack, thus allowing a universal input without precautions as to whether the input is pure A.F. voltage or a composite of A.F. and D.C. voltage.

Switch Sw.7, aside from being a modulation selector, is also a selector for modulated and non-modulated R.F. current.

The plate load of the modulator is a pie-wound R.F. choke. The advantage of such a type, is that it is self-tuning or an automatic resonator as the pies become part inductance and part capacity in a ratio that varies according to the band of frequencies (Fig. 1C) of which the incoming signal is a part. The plate load, which is capacity-coupled to a network comprising R3, R4, C12, C13, C14 and Sw.4, and the plate-load L2. R4 is a dual control of equal and uniform resistances, connected so that the output has a constant resistance. Such a method of attenuation is free from detuning as the output characteristic is always constant.

As previously stated, the electron coupling between oscillator and modulator is also an aid to stability since electron coupling, unlike other coupling methods, is not affected by atmospheric variations.

Switch Sw.5 affords either high or low output. The A.F. modulation is also externally obtainable. The output of the A.F. oscillator can be attenuated, like the R.F. oscillator, from the minimum to maximum value of R10; likewise the generated A.F. can be varied in 10 steps by means of Sw.6 and its associated condensers, C20 to C28.

The oscillatory circuit is of the Hartley type using a center-tapped A.F. transformer (L11 in Fig. 2) of low value; a midjet transformer is very suitable due to the lesser number of turns. The inductance of the A.F. transformer can be greatly reduced by removing part, or all, of the laminations. By "part of the laminations" is meant in having an open-core transformer, such as the case of an E-I shaped lamination combination, where the E laminations remain as the core of the transformer and the I sections are omitted. The reduction of the transformer inductance is important, so as to cover the high frequencies to at least 6,000 or 8,000 cycles. The frequencies generated by the A.F. generator should be: 25-75-150-400-800-1,000-2,000-3,500-5,000-7,500; the average output should be 5 V. The condenser values depend upon the A.F. transformer inductance. The A.F. oscillator is highly filtered and shielded like the R.F. oscillator.

The principal uses of the audio oscillator are given in Table II.

TABLE II

1. To test the amplifying characteristics, at various frequencies, of A.F. transformers, chokes and resistance-coupled A.F. amplifiers.
2. To check the amplifying characteristics and tone of A.F. amplifiers in receivers and other devices for coupling the loudspeaker to the tubes.
3. To check the frequency response of all reproducing units.
4. To supply an exciting source to a bridge.
5. To check open and grounded circuits in A.F. amplifiers (with headphones, or the reproducer of the receiver or amplifier, as the audio checking instrument).
6. To supply a modulating source to an R.F. oscillator.

(In Part II the construction of the oscillator unit will be concluded.—Editor)

TOOTH DECAY GERMS KILLED BY RADIO

HIGH-FREQUENCY radio waves have found one more use, according to a report of the American Association for the Advancement of Science.

In 105 cases of infected tooth roots treated by the high-frequency currents, the bacteria were destroyed in 28.6 per cent of the cases. Work is being continued in an effort to learn more about this subject.

Please Say That You Saw It in RADIO-CRAFT

The CINAUDAGRAPH
Magic Magnet **SPEAKER**



REVOLUTIONIZES ALL SPEAKER CONCEPTS

When we designed the Magic Magnet Speaker we cast aside all old speaker standards. In every detail of its design—its construction—its materials—the Magic Magnet Speaker is new!

- IT'S NEW IN CONE CONSTRUCTION
- IT'S NEW IN MAGNETIC MATERIAL
- IT'S NEW IN VOICE COIL CONSTRUCTION
- IT'S NEW IN SPIDER CONSTRUCTION
- IT'S NEW IN BAFFLE CONSTRUCTION

Every part used in the construction of the MAGIC MAGNET SPEAKER is produced exclusively by Cinaudagraph Corporation.

Clip the coupon and get the details on this really **MAGIC MAGNET SPEAKER**.

CINAUDAGRAPH CORPORATION
Stamford, Conn.

Gentlemen:
Please forward immediately your latest catalog on the Magic Magnet Speaker.

NAME

ADDRESS

CITY STATE RC65

CINAUDAGRAPH CORPORATION

STAMFORD, CONN., U.S.A. Dept. RC

FREE

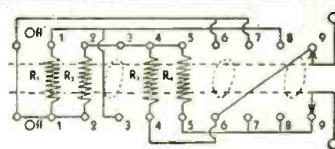

Semi-Precision CONTINENTAL Carbon

condensers and resistors are available in matched sets for decade circuits.

Now you can economically build these useful decade capacity and resistance standards for your radio or experimental laboratory.

Send for your FREE plans!

Please send me your FREE Build-it-Yourself Plans and Bulletins.

Name

Address

City

My Jobber is

CONTINENTAL CARBON Inc.

13914 Lorain Ave. Cleveland, Ohio

Sound Projection . . . At Its Best
 WITH THE NEW, SCIENTIFICALLY DESIGNED
LIFETIME
SOUND PROJECTION BAFFLES

More perfect reproduction of announcements, public speakers and musical renditions with exceptionally wide range of directional sound delivery in Stadiums, Convention Halls, Auditoriums and in fact all types of large gathering places both indoors and out, where the managements must keep large numbers of people informed and entertained, is now possible with Lifetime Equipment.

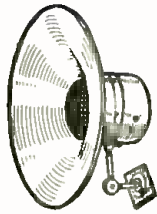

Below are listed a few of the seasonally low prices offered direct to Sound and P. A. Men:
 No. 32-32" Baffle for all 12" speakers. List \$10.00, Net Distributor price, \$16.95.
 No. 20-20" Baffle for 8" speakers. List \$30.00, Net Distributor price, \$12.95.
 No. 15-15" Baffle for 6" speakers. List \$18.00, Net Distributor price, \$7.95.
 No. 4-4" 4-Foot Aluminum Trumpet. List, \$15.00, Net, \$18.95.
 No. 6-6" 6-foot Trumpet. List, \$70.00, Net, \$28.95.
 No. 8 ED Electro Dynamic Speaker. List, \$55.00, Net, \$22.95.
 No. 70 Lifetime Velocity Mikro. List, \$40.00, Net, \$16.95.
 No. K6 Lifetime Crystal Mikro. List, \$22.50, Net, \$12.95.
 No. 88 Lifetime D. B. Microphone. List, \$20.00, Net, \$9.95.

All orders sent from this ad and accompanied by remittance in full will be shipped PREPAID. Sound Men, send for our literature of microphones and sound equipment at America's lowest prices.

LIFETIME CORP.

1012 MADISON AVE. Mfg's. TOLEDO, OHIO
 Carbon, condenser, crystal, electrostatic and velocity microphones—electro dynamic speakers, aluminum trumpets and sound projectors.

SAVE \$\$\$ on RADIOS
 BUY DIRECT 30 day trial FREE CATALOG
 Buy at factory prices. 30 models to choose from. A.C. D.C. All-wave. Farm, Car and Metal Tube models. Send postcard for NEW 1936 Bargain Catalog FREE. Get details of 30 day TRIAL plan and Agent-User proposition. Also ask for our NEW Parts Catalog.
ZEPHYR RADIO CO.
 11798 Livernois, Detroit, Mich. DEPT. 226

RADIO ENGINEERING

RCA Institutes offers an intensive course of high standard embracing all phases of Radio. Practical training with modern equipment at New York and Chicago schools. Also specialized courses and Home Study Courses under "No obligation" plan. Catalog. Dept. RT-36.

RCA INSTITUTES, Inc.
 75 Varick St., New York 1154 Merchandise Mart, Chicago
 Recognized Standard in Radio Instruction Since 1909

HAVE YOU SOME SPARE ROOM

a basement or garage where you can do light work. We can offer you a profitable proposition for 1936 casting 5 and 10c Novelties, Ashtrays, Toy Automobiles, etc., as Branch Manufacturer for a firm of many years standing. No experience necessary and small outlay starts you so if you mean strictly business and are interested in devoting your spare or full time to profitable work write at once for full details.

METAL CAST PRODUCTS CO. Dept. 26
 1696 Boston Road New York, N. Y.

JENSEN 8" SPEAKER

1800 or 2250 ohm field,ea. \$219
 TRF KIT: Includes 1 Ant. coil, 2 RF coils, Dejur 3-gang variable condens-cr. . . .Price \$125
 Write for FREE RADIO PARTS Circular
ARROW SALES CORP., 631 Washington Blvd., Chicago, Ill.

Manufacturers of
VITREOUS TRANSMITTING GRID LEAKS
VOLUME CONTROLS • POWER RHEOSTATS
 Write for Complete Free Catalog
ELECTRAD, Inc.
 175 Varick Street, New York

A SIMPLIFIED DECADE RESISTANCE BOX

(Continued from page 727)

within 5 per cent of their rated value. After assembling the individual switches with their resistors they should be mounted on a suitable panel and wired in series, as indicated in the diagram. Only 2 binding posts are necessary because at the "off" position of the switch a shunt eliminates all resistors from the circuit. The unit illustrated has a range in 100-ohm steps, from 100 ohms to 999,900 ohms, with a normal capacity of 1 W. per decade continuous, or 5 W. per decade in momentary overloads.

This is probably the simplest type of decade resistance box, using the least number of resistors, that can be made. It offers a saving of some \$10.00 to \$50.00 over the cost of an equivalent old-style decade resistance box.

If additional ranges are desired they may be added at either end of the suggested circuit by merely choosing the correct ohmic value for the individual resistors, as is indicated in the List of Parts.

The greatest economy is achieved through using semi-precision insulated carbon resistors which have been found to be at least 50 per cent more accurate than the ordinary resistors employed in radio receiving sets. (The writer recommends Continental Carbon semi-precision insulated resistors for each decade as their special ceramic coating will provide ample protection against short-circuits and deterioration through oxidation.)

LIST OF PARTS

One set of semi-precision 1 W. insulated carbon resistors, measuring as follows:

Decade No.	RESISTOR			
	R1	R2	R3	R4
1	100	200	400	500
2	1,000	2,000	4,000	5,000
3	10,000	20,000	40,000	50,000
4	0.1-meg.	0.2-meg.	0.4-meg.	0.5-meg.

Four double-deck, shorting-type rotary 9-point switches (*);

Four small tapered knobs to fit the switches;

Two binding posts;

One 3/16-in. bakelite panel 6 x 6 1/2 ins.;

One small box at least 2 1/2 ins. deep to take the panel and assembly.

(*) The off position must also have 2 active contacts on this switch.

This article has been prepared from data supplied by courtesy of Continental Carbon, Inc.

STATION INTERFERENCE

SERVICE MEN who find it difficult to sell customers on the idea that a stage of R.F. ahead of the first-detector might go a long way toward eliminating cross-talk, may want to show the following item to these customers, who complain in loud tones that the big broadcast stations wander from their assigned frequencies.

A letter was sent to J. R. Poppele, chief engineer of WOR, by the N. Y. Daily Mirror, from a Brooklyn reader of the newspaper who complained bitterly that WOR programs were audible as background when a radio set only 7 months old was tuned to any one of a half-dozen or more local stations. Some illuminating facts concerning the maintenance of a modern broadcast station are contained in Mr. Poppele's reply, from part of which we quote as follows:

"Complaints of this nature have come to our attention and upon investigation the source of the difficulty has always been found to be inherent in the design of the receiver, regardless of whether the receiver is of old or new design.

"Unfortunately manufacturers sometimes ship receivers which have not been thoroughly adjusted, especially sets of the superheterodyne type. At our transmitter at Carteret, N. J., it is possible for us with a small \$39.00 receiver to tune in any and all metropolitan stations including WJZ and WEAF which operate on channels directly adjacent to WOR's frequency.

"WOR's frequency adjustment on 710 kc. is controlled by duplicate crystal oscillators. These are checked by RCA weekly and since these observations have been made for the past 11 months, the greatest deviation has been exactly 4 cycles out of the 50 cycles allowed by the F.C.C."

12 BOOKS TO HELP YOU LEARN MORE ABOUT RADIO



Illustrated at the right and left are two books in the Radio-Craft Library Series.



THE RADIO-CRAFT LIBRARY SERIES—a most complete and authentic set of Volumes—treats individually, important divisions of radio. Each book has been designed to give you the opportunity to learn one or more branches of radio. The authors of the books are well-known to everyone. Each is an expert radio man; an authority on the subject—each is thoroughly familiar with the field which he represents.

All Books Uniform

The volumes in the RADIO-CRAFT LIBRARY SERIES are all uniform, 6 x 9 inches. Each book contains on an average of 50 to 120 illustrations. The books are printed on an excellent grade of paper which makes the type easy reading.

Here Are the Series:

- Book No. 1
RADIO SET ANALYZERS
And How to Use Them By L. VAN DER MEL
- Book No. 2
MODERN VACUUM TUBES
And How They Work By ROBERT HERTZBERG
- Book No. 4
MODERN RADIO HOOK-UPS
The Best Radio Circuits By R. D. WASHBURNE
- Book No. 5
HOW TO BECOME A RADIO SERVICE MAN
By LOUIS MARTIN
- Book No. 6
BRINGING ELECTRIC SETS UP TO DATE
By CLIFFORD E. DENTON
- Book No. 7
RADIO KINKS AND WRINKLES
For Service Men and Experimentors
By C. W. PALMER
- Book No. 8
RADIO QUESTIONS AND ANSWERS
By R. D. WASHBURNE
- Book No. 9
AUTOMOBILE RADIO AND SERVICING
By LOUIS MARTIN
- Book No. 10
HOME RECORDING AND ALL ABOUT IT
By GEORGE J. SALIBA
- Book No. 11
POINT-TO-POINT RESISTANCE MEASUREMENTS
By CLIFFORD E. DENTON
- Book No. 12
PUBLIC ADDRESS INSTALLATION AND SERVICE
By J. T. BERNSELY

BIG DISCOUNT OFFERED

When Five (5) Books or More Are Ordered, Deduct 20% from Your Remittance

GERNSBACK PUBLICATIONS, INC.
 99 Hudson Street, New York, N. Y.

MAIL THIS COUPON TODAY!

GERNSBACK PUBLICATIONS, INC.
 99 Hudson Street, New York, N. Y.

I have circled below the numbers of books in the RADIO-CRAFT LIBRARY SERIES which you are to send me, and have deducted 20% for ordering five (5) books or more. I have included my remittance in full, at the price of 50c each, when less than five books are ordered.

The amount of my remittance is.....
 (stamps, checks or money orders accepted). Circle numbers wanted:

1 2 3 4 5 6 7 8 9 10 11 12

Name

Address

City State.....

All books are sent postage prepaid R-636

Please Say That You Saw It in RADIO-CRAFT

ELECTRONIC MUSIC FUNDAMENTALS

(Continued from page 737)

pulleys the table below is provided for frequencies starting from C¹ to B¹ (at A⁴-440):

C	32.70	E	41.20	G#	51.91
C#	34.64	F	43.65	A	55.00
D	36.70	F#	46.24	A#	58.27
D#	38.89	G	48.99	B	61.73

By using this table the speeds of the shafts can be computed as follows: C shafts equal 32.70 revolutions per second; C#, 34.64 revolutions per second, etc.

Compensation must be made for the thickness of the belt, which can be made of regular friction tape.

Each shaft contains a number of washers serving as phonic wheels, which are assembled press-fit, and equally spaced from each other (see Fig. 10).

In order to simplify construction the phonic wheels are made out of standard shapes of material which are available to the experimenter. For example, the first row of phonic wheels on all shafts which are designed to produce the first octave of tones are made out of round stock with a hole drilled off-center. The second-octave phonic wheels are made rectangular in shape. The third-octave phonic wheels are made of square stock, etc., etc.

All shafts are driven by an endless belt from a constant-speed or synchronous motor. (The pulley of the motor must be computed so that the note A⁴ will be 440 cycles per second.)

The upper part of Fig. 10 shows the arrangement of magnet pick-ups mounted on suitably rigid supports. A "U"-shaped metal core can be made either of permanent-magnet steel (chromium and tungsten), or armco iron, with an exciting coil having connections to a storage battery of 6 V. or less.

The key arrangement as shown in the photographs C and D is made for finger touch, and does not involve expense in its construction. The finger touch is shown by dotted lines in the diagram in Fig. 10. If conventional organ key actions are used each key is provided with a switch contact of any suitable design.

To avoid complication in the explanation of Fig. 10 a stop arrangement and a synthetic mixer of the currents from the phonic wheels is omitted, but will be illustrated in future articles.

USING THE "ORGAN"

After the completion of this home-made electronic organ, the builder probably will wish to give recitals in his church or school, and will be immediately faced with the disparaging criticism of professional organists and organ builders, who will compare his instrument to \$10,000.00 or \$20,000.00 pipe organs, instead of to a similar instrument of \$100.00, the approximate cost of his electronic organ.

The experimenter should not be discouraged, however, since practically every organist is a direct or indirect representative of a pipe organ manufacturer. He should also bear in mind that however crude his instrument, he is more advanced in the science of modern tone production than those who still adhere to expensive air pumping methods now outlived.

Recently the Association of Pipe Organ Builders has decided to declare that all electronic organs shall be called "Electrotones" instead of "Electronic Organs," with the idea that the electronic organ builder and experimenter will have no chance to sell his product to his own church "since church installations require organs!"

NEW DATA ON PORTABLE BATTERIES

(Continued from page 737)

hours (horizontal scale) that is obtained from these 3 cells, or any "B" batteries built from them in series, to the closed-circuit voltages shown on the vertical scale, at various current drains. It should be borne in mind that this service is obtainable from relatively fresh batteries at temperatures of about 70° F. Cold weather decreases and warm weather increases the capacities at the drains shown in this group.

EFFECT OF AGE

"Shelf Life" is a much mis-used expression where dry batteries are concerned and many erroneous impressions are still extant regarding it. All dry cells change with age as far as their service capacity is concerned. The only true measure of this factor is to determine the actual watt-hours output of the battery at different ages or to plot the discharge curves. Figure 1B shows the discharge curves of the X cell on a representative "B" drain at different ages up to a year. Contrary to some popular opinion the effect of age on the capacities of the W and Z cell is practically identical to this. It does not vary greatly in magnitude even in the case of very much larger cells.

INTERNAL RESISTANCE

There is probably no greater source of argument than this characteristic of dry batteries.

The variance in method of determining this factor is greatly responsible for the disagreement of results. One satisfactory method is the use of an A.C. bridge so connected that no D.C. from the cells can flow through it. When this method is used the data obtained shows very slight variation of internal resistance with the current drain. The curves in Fig. 1C illustrate this.

A NEW EXPERIMENTAL CELL

As a result of the demand in meteorological and other highly specialized transmitting work there is now available, for experimental purposes only, a new miniature cell measuring only 1/2-in. in dia. by 5/16-in. in height. This is a true Le Clanche dry cell, having an open-circuit voltage of 1.6 and although originally constructed with a view of having a potential without any considerable current-producing power, when a group was discharged the respective results shown in Fig. 1D were obtained.

The ribbon battery shown in Fig. A is constructed from these cells. In it is a "B" battery of 50 V. and an "A" battery of 3 V. containing size X cells.

Our Information Bureau will gladly supply manufacturers names and addresses of any items mentioned in RADIO-CRAFT. Please enclose stamped return envelope.

TABLE II

"RIBBON"-TYPE "B" BATTERY

Designation	Terminals	Weight	Rolled Max. Dia.	Flat Dimensions		
				L	H	W
Z30F	+22 1/2, +45 V.	17 ozs.	2 5/16	6	6 1/2	19/32
X30F	+22 1/2, +45 V.	12 ozs.	2 5/16	6	5	19/32
W30F	+22 1/2, +45 V.	8 ozs.	2 5/16	6	3 5/8	19/32

REGULAR MIDGET "B" BATTERIES

Designation	Terminals	Weight	Flat Dimensions		
			D	H	W
X30FL	+22 1/2, +45 V.	22 ozs.	1 3/4	5 1/16	2 13/16
X30FL	+22 1/2, +45 V.	13 1/2 ozs.	1 5/16	4 1/16	3 1/16
W30FL	+22 1/2, +45 V.	8 1/2 ozs.	1 3/16	3 3/16	2 27/32

Please Say That You Saw It in RADIO-CRAFT

30 WATT OUTPUT AMPLIFIER KIT WITH RCA ALL-METAL 6L6 BEAM POWER OUTPUT TUBES

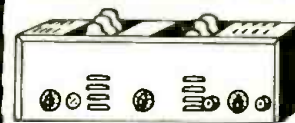

\$24⁵⁰
SIX TUBES, \$5.28 Extra

- 3 Channel Input-Mixer-Fader for Ribbon Mike (132 db. gain), Crystal Mike (90 db. gain), and Phono. Pickup (60 db. gain).
- Tubes Used: 1-6J7, 2-79, 2-6L6, 1-83.
- Electronic Mixing Employed ● 6L6 Tubes only produce 2% harmonic content distortion!
- Employs a Class "AB" Circuit ● Tone Control and Polarized Input-Output Plug Connectors included ● Ventilated Chassis.

\$24⁵⁰ 6 Volt Storage Battery Operated 20 Watt Output AMPLIFIER KIT

4-79 Tubes, \$2.92 Extra | Housed in same ventilated steel case, as above. Self-contained DYNAMOTOR.

Consumes only 6.5 amps. 2 Channel Input-Mixer-Fader for Crystal Mike (104 db. gain) and Phono. Pickup (74 db. gain.) Can also be operated from 110 Volts A.C.!

BOTH OF THESE KITS ARE FULLY DESCRIBED in a Special Bulletin No. 436. Write for your copy!

WRITE FOR OUR LATEST FREE CATALOG

We SPECIALIZE in the design and construction of AMPLIFIERS... deal direct with the mfr. and save money!

Bulletin No. 536 also contains unusual bargains in radio sets - replacement parts, etc., etc.

Remington
RADIO & ELECTRIC CORP.
106-R 7th Ave., New York, N. Y.

MILLION Tube Tester

FEATURES

1. Emission
2. Metal Tubes
3. Shorts
4. Leakage
5. Resistance
6. Electrolytics
7. By-Pass Condensers
8. Neon Alignment

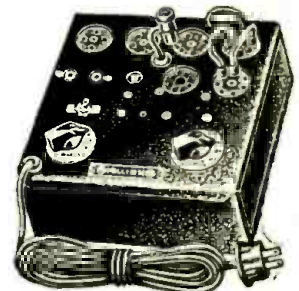

\$8⁴⁵
NET

25 cycle-\$10.95—220 V-\$9.45

Here's what the Service Men say about the New Million Tube Tester! "Most valuable purchase of test equipment we made during the last year." "It shows up weak tubes better than my expensive tester."

If your jobber cannot supply you—order direct—20% deposit required on C. O. D. orders. Tear out this ad and send it to us NOW for complete information!

MILLION RADIO AND TELEVISION LABORATORIES
363 W. SUPERIOR ST., CHICAGO, ILL.

TRI-STATE COLLEGE
Radio Engineering Degree in 2 Years

Complete Radio Engineering course in 96 weeks. Bachelor of Science Degree. Radio (television, talking pictures and the vast electronic field) offers unusual opportunities for trained radio engineers. Courses also in Civil, Electrical, Mechanical, Chemical, Aeronautical, Engineering; Business Administration and Accounting. Low tuition, low living costs. World famous for technical two-year courses. Those who lack high school may make up work. Students from all parts of the world. Located in picturesque hill and lake region of northern Indiana. Enter September, January, March, June. 2466 COLLEGE AVE. ANGOLA, IND.

A new book to add to your technical library
ABC of AIR CONDITIONING

by Paul D. Harrigan



THOSE who are first becoming interested in the fertile field of Air Conditioning will find in this book all the fundamental principles which underlie the practical systems in use today—and written in a way that can be understood by anyone. The book contains also a step-by-step description of the different types of refrigerating systems, humidifying and de-humidifying methods, air filtering units and heating plants which have been used in Air Conditioning installations, beginning with the invention of artificial cooling and refrigeration and continuing up to the latest types in use today. The man who wishes to learn about Air Conditioning will do well to start with this comprehensive book.

Brief outline of contents

- The Future of Air Conditioning
- Uses and Benefits of Air Conditioning
- Elementary Refrigerating Systems
- Types of Winter and Summer Air Conditioning Installations and their Operation
- Service and Control Applied to Air Conditioning Systems
- Ventilation Data for Air Conditioning
- Definitions Used in Air Conditioning
- Air Conditioning Books

Send fifty cents in stamps, money order or coin for your copy of the ABC of Air Conditioning—it is sent postpaid upon receipt of your remittance.

GERNSBACK PUBLICATIONS, Inc.
 99R Hudson Street, New York, N.Y.

FREQUENCY WOBBLER FOR SET ALIGNING

(Continued from page 729)

tion and therefore the output feeding to the speaker may be used for connecting into the oscilloscope. If this does not give satisfactory results, the connection may be made to the plate and cathode of the detector; or in the case of diode detection, to the plate and cathode of the first A.F. tube. This is usually the type 2A6, 55, 75 or similar tube.

After the proper connections have been made, connect each unit to the power line and turn on the switch. In the frequency wobbler turn the tap switch to No. 1 position; then tune the receiver to the frequency at which the test is to be made. Tune the service oscillator through this frequency until a 120-cycle note is heard in the speaker or a waveform appears on the oscilloscope. Now adjust the frequency of the sweep generator in the oscilloscope to 120 cycles. This is accomplished when a curve, resembling one of those shown in Fig. 1B is obtained.

After this the aligning process may begin. In order to determine the band width of the receiver the following procedure is recommended. Adjust the service oscillator to such a point where the two resonance curves cover one another. Make note of the signal-generator dial reading. Turn the service oscillator dial until the two resonance curves are alongside of one another, but with the least possible space between them. Again note the service oscillator dial reading and determine the frequency difference between the two readings. Multiply this frequency difference between the two readings by 2 to get the band width.

Example: With the resonance curves covering one another the service oscillator reads 700 kc. With the curves alongside of one another the service oscillator reads 708 kc. The band width, then, is $708 - 700 = 8 \times 2$ or 16 kc.

If the resonance curve is very wide it does not necessarily mean great band width. Turn the switch in frequency wobbler to a higher tap. This tends to narrow the resonance curve, by increasing the range of frequencies swept.

BUILD IT YOURSELF

Can be built by anyone, failure impossible. Total cost approximately \$385.00 for all materials. Our large sized blueprints and construction sheets make it a pleasure to build this smartly designed Trailer. Sleeps four—all conveniences beautifully appointed. Factory job would cost over \$1,000—build it yourself and save 75%. Plans sheet, completely illustrated and detailed for 25c stamps or coin. The Trailer Plan Shop, 510-919 N. Michigan Ave., Chicago



NEW! THE LARGEST AND FINEST CATALOG OF THEATRE SOUND AND PUBLIC ADDRESS EQUIPMENT EVER ISSUED!

FREE ON REQUEST

Hundreds of new items, valuable charts, data, etc., amazing money-making BARGAINS TO SELL!

S. O. S. CORP. 1600 B'way, N. Y. C. cable "SoSound"

NEON

Fascinating home-study course prepares you quickly for today's biggest opportunity—NEON—"Gaseous tube" lighting—most widely used medium of lighted displays, the future's greatest source of illumination. Trained men needed in every locality! Start now while the industry is still new!

FREE Booklet describes NEON'S opportunities, complete data on C. L. home-study course. Enrollment fee amazingly low. Write for **FREE BOOK!** Commercialite Laboratories, Box 47-R, Omaha, Neb.

RADIOS AT A GREAT SAVINGS BUY DIRECT

Many models to select from. Factory prices. A.C.-D.C. All Wave, farm, car, and new metal tube models. Send postal card for new 1936 bargain catalog free.

THIRTY DAYS TRIAL

FREE CATALOG

AUTOCRAT RADIO COMPANY

3855 North Hamilton Avenue Dept. 250 Chicago, Illinois

RADIO ENGINEERING,

broadcasting, aviation and police radio, servicing, marine radio telegraphy and telephony, Morse telegraphy and railway accounting taught thoroughly. Engineering course of nine months' duration equivalent to three years of college radio work. All expenses low. Catalog free. School established 1874.

Dodge's Institute, Hudson St., Valparaiso, Ind.

BOOK REVIEWS

RADIO RECEIVING AND TELEVISION TUBES by James Moyer and John Wostrel. Published by McGraw-Hill Book Co., 1936. Size 6 x 8 1/2 ins., 635 pages. Price, \$4.00.

This is the third edition of this popular book and has been completely revised to include the most modern tube developments. Metal tubes, multi-purpose tubes and many others are included. Such material of the older editions as was deemed unnecessary was omitted to make room for new material. The chapters on television tubes is new and that on industrial applications is of especial interest, since this field is growing so rapidly nowadays.

EXACT MEASUREMENTS OF THE SPOKEN WORD. Compiled and published by the Columbia Broadcasting System, 1936. Size 7 1/4 x 10 1/2 ins., 32 pages.

This interesting compilation is intended to prove that the radio advertiser can get better results from aural than from visual stimulation of his prospective market. It is composed of abstracts and summaries, observations by various scientists from 1902 to 1936.

PHENOMENA IN HIGH-FREQUENCY SYSTEMS by August Hund. Published by McGraw-Hill Book Co., 1936. Size, 6 1/2 x 9 1/4 ins., 642 pages. Price \$6.00.

A very complete exposition of electronic phenomena is contained in this volume. Mathematics is used extensively in support and proof of various theorems. The high frequency field is covered in great detail and much equipment and many circuits not widely used are presented for the sake of completeness. A detailed treatment is made of many theories connected with high frequency work.

This work is one of the most complete of its kind and may well be used as an advanced text by those who are interested in this field. An appendix is included which contains many useful tables, solutions of representative electrical problems and other data of use to the serious experimenter and reader.

REVIEW OF BOOKLETS AND NEW CATALOGUES.

Electrad Volume Control Guide. Free to authorized Service Men and dealers. This compact work contains 100 pages of data useful to the Service Man. There are many circuits showing the use of various types of volume and tone controls, and much other such data, and a listing of replacements for most any set made.

United Transformer Corp. latest transformer guide. Here are 40 pages of transformers, chokes, charts, curves, circuits, and other necessary information for the Service Man and experimenter. Data is included on db. ratings, power supply filters, application of power transformers, etc. The number is bulletin U1100C.

No. 1047. A new, 1936-7 issue Volume Control Replacement Guide, 79 pages in length. Contains list of replacements for hundreds of sets as well as much useful, practical information.

No. 1048. Condenser and Replacement Manual. Information on condenser mounting, surge voltage ratings, etc. The comprehensive list of condenser replacements contains installation instructions for each type of condenser listed. Also contains a complete listing of the company's products.

No. 1049. Resistor Replacement Manuals Guide. This 159 page booklet lists replacements for over 5,000 sets. There are many pages devoted to the use of variable resistors and other general service information. It is free to any accredited Service Man.

The Electric Eye in Theory and Practice, published by Hugh H. Eby, Inc. Price, 50 cents. Contains elemental and more advanced circuits using P.E. cells for various purposes. Also the theory of operation of these cells and their associated equipment. There are 32 pages; one of which is devoted to the symbols used so that the book may be understood by the inexperienced.

Please Say That You Saw It in RADIO-CRAFT

LOCAL B-1004 FAVORS "CRAFT" RADIO UNION

FOR YEARS a number of radio Service Men have labored industriously to become affiliated with the A. F. of L. as craftsmen who ply their trade by virtue of years of training, education and experience. The necessity for a knowledge of electrical theory, radio principles, and the use of instruments must be an accepted fact, in view of the complicated circuits and mechanism the Service Man is required to service.

He has been continuously exploited by irresponsible "unions" or "clubs" who never had the interest of these men at heart, but who were more concerned with the dues paid in and the publication of some journal and the attendant advertising revenues that resulted because of the support lent to the publication by the Service Men. While teamsters and laundry workers, with A. F. of L. affiliation, were receiving a wage scale of approximately \$40.00 a week, these responsible clubs or organizations were exhorting their members to purchase new and more expensive equipment, without even attempting to improve their economic status. So-called educational lectures, sponsored by the clubs—by arrangement with manufacturers, were more or less disguised publicity talks given with the purpose of interesting members in some new instrument or the products of some concern.

Consequently, when the International Brotherhood of Electrical Workers consented to give radio Service Men a charter with separate autonomy, the opportunity that they were always seeking—was immediately grasped. Now that they are enabled to function as an individual group, uplift their profession and ameliorate their problems—along comes an Industrial Radio Union who would classify them with unskilled radio factory workers, and place them all in one group.

Can anyone wonder at the resentment of Service Men to this group who would undo all that the Service Men strived for, for many years; at the resentment of a body of men who diligently apply themselves to their art, studiously refer to intricate diagrams of elaborate automatically controlled receivers, painstakingly review magazines and literature to keep informed on their profession—to those who would place them in the same category as an assembler or coil winder, simply because they all happen to be in the radio profession?

The economic problems of the radio Service Men are not, in most instances, comparable with the radio factory worker. For years, the legitimate and earnest radio Service Man has had to combat encroachments and evils introduced by men and concerns who would exploit the owner of a radio set. The tremendous harm which has resulted because of the activities of such men and concerns has reflected sadly on the servicing profession. Outstanding among the evils which they are forced to contend with, are

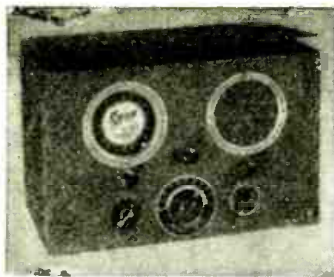

HAYNES R-S-R-

5-TUBE RECEIVER

2 1/2-555 METERS

Regeneration plus super-regeneration

Combined for the first time in a single A.C.-D.C. receiver having the greatest tuning range ever incorporated in one set. A. J. Haynes, who designed the first regenerative kit (1922) and the first superheterodyne kit set (1924) chose RACO to build the final model of his new R-S-R receiver—another first AND DOES IT PERFORM!

The R-S-R is not only a remarkably fine DX receiver for all of the short wave and broadcast bands but it is the smoothest super-regenerator we have ever seen, giving exceptionally efficient reception on the 5 and 10 meter bands.

Complete Kit, unwired, including dynamic speaker, power supply and wired switch-coil assembly (less cabinet and tubes) **\$14.95** Complete R-S-R set, with 5 tubes (2-MG-6K7's, 1 MG43, 1 MG-25Z5, 1-76) matched dynamic speaker, cabinet, all wired and laboratory tested. READY TO PLUG IN AND OPERATE. **\$24.65**

RADIO CONSTRUCTORS LABORATORIES



136 LIBERTY ST., N.Y.C. Dept. R.C.6 EXPORT DEPT. 105 Hudson St.

UTC Presents a New, Portable, High Fidelity PA Amplifier

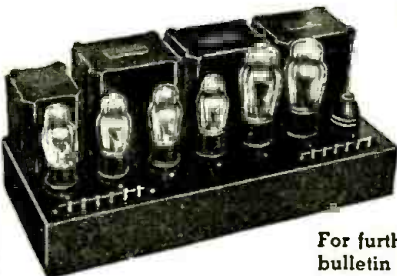

HIGH POWER OUTPUT WITH LOW COST, LOW VOLTAGE TUBES.

- 30 watts normal A prime output—50 watts peak.
- Employs three push pull stages—tube used: 4-6C6's, 2-6A3's, 1-45, 1-83.
- Gain 80 db.
- Frequency response uniform from 30 to 16,000 cycles.
- Universal input connections from 50 to 500 ohms.
- Universal output connections from 1.2 to 500 ohms.

For further details, write to Mr. Barnes for 48 page U 1100 D bulletin fully describing this and other amplifiers up to 1,000 watts output . . . Include 10c to cover cost of mailing.

UNITED TRANSFORMER CORP.

76 SPRING STREET NEW YORK, N. Y. EXPORT DIVISION - 15 LAIGHT STREET, NEW YORK, N. Y.

the outfits who advertise "free" or "50c service"—with the sole purpose in mind of removing the receiver chassis so that they can demand any service charge they see fit. Such concerns, if ever, seldom employ bona-fide Service Men, and in reality, use high-pressure salesmen, who, under the guise of Service Men, convince the consumer of the necessity of removing the set and then later split profits with the concern.

But the organized Service Man can and will rectify these evils. He can only do this by concerted effort, and success can only be assured by the fact that his associates have problems and a cause in common.

BUILD THIS BEGINNER'S 2-TUBE ALL WAVE SET

(Continued from page 733)

- 50 V., C8;
- One Solar fixed condenser, 0.001-mf., 300 V., C9;
- One I.R.C. gridleak, 2 megs., 1/4-W., R1;
- One Electrad potentiometer, 50,000 ohms, R2;
- One I.R.C. resistor, 0.1-meg., 1 W., R3;
- One I.R.C. resistor, 0.25-meg., 1 W., R4;
- One I.R.C. resistor, 0.5-meg., 1/4-W., R5;
- One I.R.C. resistor, 600 ohms, 1 W., R6;
- One high-impedance A.F. coupling unit (secondary of mike-to-grid transformer used in set), Ch.;
- One set of Hammarlund short-wave plug-in coils, type SWK-4, L1;
- One Hammarlund broadcast plug-in coil, type BCC-4, L1;
- Two octal wafer sockets, for V1, V2;
- One Hammarlund 4-prong coil socket, type S-4;
- One Hammarlund R.F. choke, 2.1 mhy., R.F.C.;
- One phone strip;
- One "Ant-Gnd" terminal strip;
- One 6- or 4-prong connecting plug;
- One metal chassis;
- One airplane dial;
- One National Union, Sylvania, or RCA Radiotron metal tube, type 6J7, V1;
- One National Union, Sylvania, or RCA Radiotron metal tube, type 6F6, V2;
- Wire, hardware, etc.

Fig. 3. Three power supplies for the two tube set. At A is a battery supply; at B is an A.C.-D.C. supply; and at C is an A.C. supply.

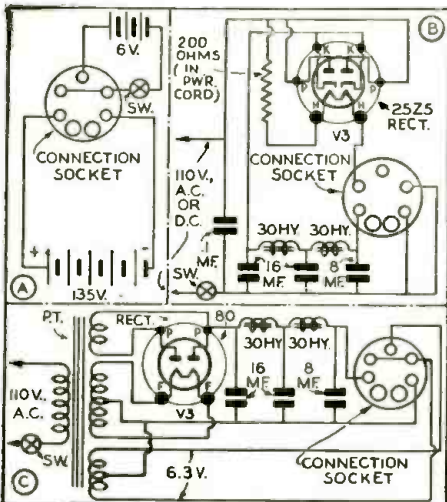

Portable, FOLDING PARABOLIC FLARE Baffle



PATENT PENDING

New, weather-proof, parabolic flare baffle constructed of extra-heavy gauge aluminum. It is portable and can be folded, together with stand, to fit specially designed carrying case. Accommodates 10, 11 and 12 inch cone speakers. Reducer rings permit use of speakers smaller than those of 12" in diameter.

DEALER NET PRICES

- Parabolic Baffle \$7.50
- Baffle Stand 6.90
- Mounting Bracket 1.50
- Carrying Case 7.50
- Weatherproof Cover 1.80
- Metallic Grill to Protect Cone of Speaker 1.50
- Reducer Ring50

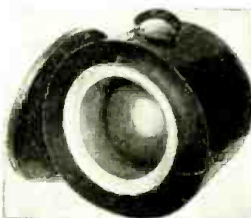

Carrying case conveniently holds folded parabolic flare baffle and telescopic stand. Cover of carrying case serves as base of stand. When packed, equipment measures only 13 inches in height by 18 inches in diameter.

ACME SOUND COMPANY
2758 BROADWAY NEW YORK, N. Y.

Please Say That You Saw It in RADIO-CRAFT

TWO NEW



RADIO BOOKS

In recent months the radio public has been made aerial-conscious by virtue of the many articles and advertisements on Aerial Equipment which have appeared in many radio magazines. As a consequence, the demand for a low-priced book explaining in a clear, lucid manner the principles underlying the design and installation of efficient aeri-als has become a need. For the thousands of radio fans, both short-wave and broadcast, who wish to know just what type of antenna they should use and why, this book has been especially published.

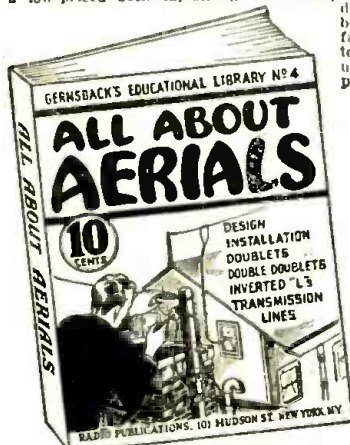

ALL ABOUT AERIALS

In simple, understandable language this book explains the theory underlying the various types of aeri-als; the inverted "L," the Doublet, the Double Doublet, etc. It explains how noise-free reception can be obtained, how low-impedance transmission lines work; why transposed lead-ins are used. It goes into detail on the construction of aeri-als suitable for long-wave broadcast receivers, for short-wave receivers, and for all-wave receivers. The book is profusely illustrated in a manner which will appeal to the most inexperienced in radio; clear, self-explanatory; it is written in so simple a style that it will clear up the aerial

In this book for beginners, we explain in a simple, lucid manner: How Alternating Current is Generated; What its Properties Are; What the Laws Governing It Are, and How It is Applied To Everyday Household Use. Furthermore, we give in simple language detailed instructions on how to perform practical experiments with alternating current in the home.

ALTERNATING CURRENT FOR BEGINNERS

This book contains everything necessary to give the beginner his first foothold in the study of electricity and radio. Electric circuits are explained with simple analogies to hydraulic systems. Ohm's Law, one of the fundamental laws of radio, is thoroughly explained; the generation of alternating current; sine waves; the units—volts, amperes, and watts—are explained. Condensers, transformers, A.C. instruments, inductors and generators—all these are thoroughly discussed. Household wiring systems, electrical appliances and electric lamps—nothing has been left out.

Here are some of the practical experiments which you can perform at home. Simple tests for differentiating between alternating and direct current; how to light a lamp by induction; how to make a simple electric horn; how to demagnetize a watch; how to test motor armatures; how to charge storage batteries from A.C. outlet; how to test condensers with A.C.; how to make A.C. electro magnets; how to fry eggs on a cake of ice; how to make simple A.C. motors and many others.

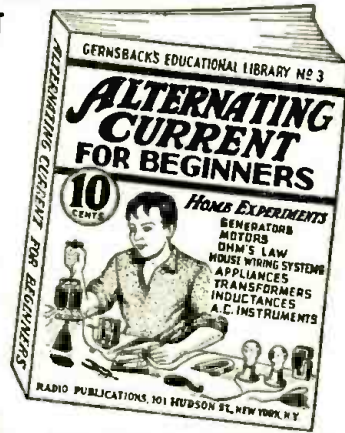

RADIO PUBLICATIONS RC-636
99A Hudson Street

- Please send immediately books checked:
- All About Aerials, Book 410c
 - Alternating Current for Beginners, Book 310c
- I am enclosingc; the price of each book is 10c.
(Coin or U.S. Stamps acceptable.) Books are sent postpaid.

Name

Address

City State

situation in your mind, once and for all. Such a wealth of information is presented in this book that you will wonder how it can be done at this low price.

NOTE: Various types of aeri-als for the amateur transmitting station are explained, so you can understand them.

Each book contains 32 pages, profusely illustrated with clear, self-explanatory diagrams. It contains over 15,000 words of clear, legible type. It is an education in itself and lays the ground-work for a complete study of radio and electricity.
At the extraordinary price of 10c, you cannot possibly go wrong. Despite its low cost, however, our usual guarantee goes with this book.
If you do not think that this book is worth the money asked for it, return it within 24 hours and your money will be instantly refunded.

RADIO PUBLICATIONS, 99A Hudson St., New York, N. Y.

THE LATEST RADIO EQUIPMENT

(Continued from page 734)

"COMBINATION" P.A. SYSTEM (1019)

OPERATION on either 110 V. A.C. or 6 V. D.C. is obtained at the flip of a switch, in this self-contained amplifier. A built-in generator supplies 350 V. at 150 ma. for the 6 V. use. The amplifier is supplied in either 20 or 40 W. size. Tube complement: 1—6C6, 1—76, 1—6A6, 1—5Z3; and 2—(20-W. unit), or 4—(40-W. unit) 6B5 output tubes. Includes mike and phono. mixer, tone control, and crystal pickup. Output impedances: 4, 8, 16 and 500 ohms. The 40 W. amplifier provides dual-channel output, and 20 or 40 W. power output.

DUAL-WAVE, GENERATOR-"B" METAL TUBE CAR-RADIO SET (1020)

THE LATEST metal tubes, 2—6K7s, 1—6A8, 1—6Q7, 1—6C5, 1—6F6, are used in this advanced outfit. A motor-generator high-voltage supply is employed. There are 2 tuning bands, 540 to 1.715 kc., and 2,200 to 6,800 kc. The receiver is very compact, measuring 7 x 11½ x 7½ ins. deep. An I.F. of 250 kc. is used. The whole set slides out of the case for easy access to the parts.

ANTENNA COMPENSATOR (1021)

SEVERAL purposes are served by this instrument. It may be used to tune the antenna to enable more efficient reception on any wavelength; stations never before heard can be "brought in." Also it is useful as a wavetrap to eliminate interfering signals; a slight adjustment, and presto! tunable interference (a strong local station, etc.) disappears.

All tuning is accomplished by rotating the knob on top of the case, as shown. Four wires of different colors that emerge from the case are

used for various connections between the receiver, and the antenna and ground.

A profitable gadget to keep handy in the old kit-bag, since it takes only a few seconds to demonstrate its usefulness.

UNIVERSAL METER (1022) (Clough-Bregle Co.)

A FAN-TYPE meter which is 5 ins. across makes reading on this instrument easy. The ranges are as follows: 15, 150, 750 V., in both A.C. and D.C.; 1.5, 15, 150 ma.; 100, 20,000 ohms, and 2 megs. All ranges are selected by a single rotary switch. The case measures only 8¼ x 5¼ x 4½ ins. deep, and contains all necessary batteries.

NEWEST LIGHT INDICATOR (1023) (Weston Electrical Inst. Co.)

COMPACTNESS is an outstanding feature of this instrument. The light-sensitive cell is located in the dial of the meter. The scale is divided into 5 zones, with the brief description of each written on the scale, and a complete table on the rear of the instrument case. A very wide range of illumination values can be accommodated, with the scale so spaced that low levels are fully and legibly indicated.

ALLOY RECORDS (1024) (Universal Microphone Co.)

THESE records are made of a special heat-treated, highly-polished aluminum alloy, and may be stored for any length of time without fre-

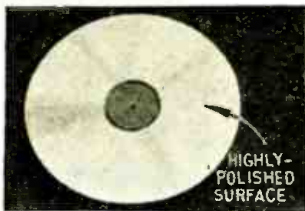

No. 1024, left. Polished aluminum records.



No. 1021, lower left. Useful antenna compensator.

No. 1023, below. Light indicator.

No. 1022, right. Universal meter.



Please Say That You Saw It in RADIO-CRAFT

quency loss or accumulation of background noise. High-quality recordings may be made on these discs.

HIGH VOLTAGE CONDENSERS (1025)
(Aerovox Corp.)

THE condenser shown at A may be had in ratings up to 4,000 V., while that at C is rated up to 2,000 V. Both are of the oil-filled type, the larger being in a tin can, while the round type is in an aluminum can. The condenser at B is in a cast-aluminum case and may be had in types as high as 7,000 V.; it is of mica-dielectric construction, while A and C are paper-wound.

COMPACT OSCILLATOR (1026)

A RANGE of 100 kc. to 70 mc. is provided by this oscillator. Two attenuators, one a vernier, are provided. Dial is direct-reading. Output at R.F. and A.F. is available at jacks, which also permit connection of an external modulator. Models for use on A.C. or with self-contained batteries are made.

Cases of cast aluminum, with a separate compartment for batteries. A 400-cycle note is used; modulation is about 35 per cent. Excellent for car-radio service.

PORTABLE P.A. UNIT (1027)
(Olympia Radio & Sound Co.)

COMPACTNESS and light weight are features of this equipment. Yet quality of reproduction does not suffer, since only the best grade of materials is used. The tube complement is 3-6A6s, giving a gain of 100 db. and a power output of 12 W. The current required is 9 A. at 6 V. Input is high impedance, and output is 2, 4, 8, and 15 ohms. A unique arrangement allows the use of microphone, radio or pickup simultaneously. The high voltage is supplied by a motor-generator, which is mounted on rubber and has sealed ball bearings to insure long life. Connections are made by polarized plugs. The unit weighs only 24 lbs.

(Continued from page 735)

P.E.-TYPE OIL TESTER (1032)

CAR-RADIO Service Men, particularly those who have leased space in a service station or garage, should keep their eyes open for opportunities to sell and service the new oil testers that utilize a photoelectric cell. One new unit of this sort is here illustrated; the oil is shown drawn into a windowed sampler that is then introduced in the path of the exciter-lamp beam. Sludge, solids, moisture, etc., tend to obscure the light, resulting in a direct-reading indication of "GOOD", through to "BAD"; there is also



A MUSICIAN CAN'T PLAY ON A BROKEN FIDDLE . . .

Neither can a service man work with "obsolete" instruments. To those having valuable but "obsolete" test equipment, we offer this opportunity to rebuild along advanced "Precision" engineering principles, AT A NOMINAL PRICE.

WRITE FOR OUR PLAN. Mention make and model number of your old SET ANALYZER or TUBE CHECKER.

PRECISION APPARATUS CORP.
821 EAST NEW YORK AVENUE Modernization Division—Dept. C BROOKLYN, NEW YORK

a percentage graduation on the dial. A caesium-type photo-cell is used, followed by a single stage of amplification, as per circuit here shown. All equipment, including the required batteries, are contained in an aluminum case, which measures 6 x 6 x 10 ins. deep.

The car-radio technician also has the entrée which would enable him to sell this type of device to the consumer, who is always open to suggestions that will reduce his service and operating costs.

"ADD-ON" CHARGERS (1033)

THE ADDITION of charging service to the other services offered by a garage or radio service station is usually a costly proposition, since the equipment must be bought with an eye to the future, in order to provide for expansion of the service. Thus a large amount of money may be sunk in equipment which may not turn out to be practical, resulting in loss to the owner.

Now, however, there is available a unit charger, the capacity of which may be increased at any time merely by the addition of similar units, which simply plug into the original charger. As a result, the owner need only buy enough equipment to cover his present needs. A portable type also available is here illustrated.

The charging rate of these units is 10 A. This rate tapers as the charging proceeds, so that there is no chance of injury to the battery.

The charging rate, as well as other interesting information is illustrated in the graph.

Upkeep of these units is very low, since the parts needing replacement cost only \$1.00, and they last an average of 1,000 hours; and the number of "add-on" units in use may be varied to meet the demands of charging anything from a single cell to a "full line."

A simple but highly effective filter built into every charger eliminates radio interference. The chargers are made for any A.C. supply, and for a variety of different cell arrangements.

WRIGHT-DECOSTER NOKOIL Dynamic Reproducer



No Field Coil or Current

The tremendous demand for the Nokoil Dynamic Reproducer more than repaid us for the many hours of strenuous study and work in developing this high quality unit.

FIRST IN THE FIELD AND STILL SUPERIOR

- For Car Radios
- For Battery Radios
- For Sound Installations

Buy through Wright-DeCoster Distributors They are always anxious to cooperate

WRIGHT-DECOSTER, INC.
2251 UNIVERSITY AVE., ST. PAUL, MINN.
Export Dept. M. Simons & Son Co., New York
Cable Address: "Simontrice"
Canadian Office, Wright-DeCoster, Inc., Guelph, Ontario

No. 1025, below. High-voltage condensers. No. 1027, right. Portable P.A. unit.

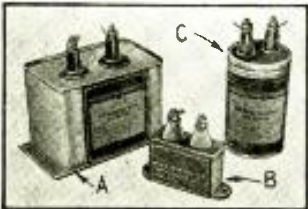
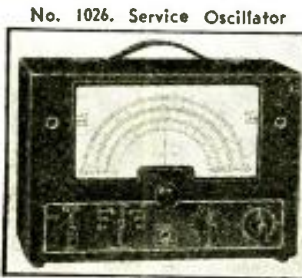

IONOSPHERE MEASUREMENTS AND THE SOLAR ECLIPSE

FEW radio men realize the importance of an intensive study of the ionosphere and the propagation of radio waves of various frequencies. When it is remembered that all long distance communication by radio, such as the trans-Atlantic telephone, long-distance commercial radiotelegraphy, etc., are directly dependent on certain conditions in the reflecting layers above the earth's surface, a better understanding of the importance of these studies will result.

For example, several times each year, coincidental with sun-spot disturbances, all short-wave communication across the Atlantic stops abruptly and remains out for an indefinite

period of time varying from several minutes to several hours.

Eclipses of the sun permit scientists to make important measurements of the height and condition of the ionized layers which reflect radio waves back to the earth. The next such eclipse takes place on June 19th—and taking advantage of an invitation of the Russian Government, Cruft Laboratory of Harvard University is sending four radio specialists with fixed and variable frequency transmitters to Ak-Bulak in northwestern Russian Turkestan (the center of the eclipse area) to make measurements during the period of darkness.

New 1936 Model \$75 LESS MOTOR DRIVE

SOUTH BEND LATHE

Write for details on this 9 in. x 3 ft. Workshop Precision, back-gear, screw-cutting Lathe. Made in 8 different drives, 4 bed lengths. Easy Payment Terms, arranged over extended period of time. Complete information on request.

Free WRITE FOR Catalog 15

WEIGHS 310 Lbs. Crated

SOUTH BEND LATHE WORKS
185 E. MADISON ST. SOUTH BEND, IND. U.S.A.

RADIO biggest opportunities still ahead

ALMOST in a decade radio has become a giant industry. The opportunities created will be enjoyed by trained men. The International Correspondence Schools Radio Course, prepared by leading authorities and constantly revised, will make you a trained man! A fascinating book—free.

INTERNATIONAL CORRESPONDENCE SCHOOLS

Box 6680-B, Scranton, Penna.
Send me—free—information on subject checked:
 Radio Radio Service Man
 Radio Operator Electrical Engineer

Name.....
Address.....

Please Say That You Saw It in RADIO-CRAFT

Mr. Serviceman
JUST OFF THE PRESS!

The NEW RADOLEK
Radio Profit Guide

Send for yours!

The Radolek New 1936 Radio Profit Guide is just off the press... completely revised—right up to the minute... Everything in Radio—at the right prices. Contains over 10,000 individual Radio Repair Parts—hundreds of new items—a complete new selection of Radio Receivers, Amplifiers, Tools, Tubes, Books and Instruments. Everything you need—always in stock... ready for prompt shipment to you. This Big Radio Parts Catalog is FREE. Send for it! Rely on Radolek for Radio. Radolek endeavors to restrict distribution of The Profit Guide to those actively and commercially engaged in the Radio Business. Please enclose your Business card or Letterhead.

RADOLEK

595 W. RANDOLPH—CHICAGO

Send me the Radolek Radio Profit Guide Free.

Name

Address

Serviceman? Dealer? Experimenter?

METAL TUBES

Have Not Made Obsolete

THE SHALLCROSS UNIVERSAL TESTER

Liberal allowance made on your obsolete meters and instruments.

RANGES:



Volts A.C.—D.C.

5-25-100-250-1000
1000 ohms per volt

Milliamperes D.C.

1-10-100-1000

Capacity

.001-10 Mfd.
Paper or electrolytic condensers.

Inductance

1-10,000 Henrys

D.C. Resistance

.5-5,000,000 ohms.

Send full description of old instrument you wish to trade-in and 6c in stamps for Bulletin 611-PF describing the Shallcross Universal Tester.

SHALLCROSS MFG. COMPANY

Electrical Measuring Instruments and Accurate Resistors

700 MAC DAVE BOULEVARD
COLLINGDALE, PA.

IGNITION INTERFERENCE INVESTIGATION

AT A recent meeting of the Sectional Committee on Radio-Electrical Coordination of the American Standards Association the special attention of the committee was called by its chairman, Dr. W. R. G. Baker, to a recently-inaugurated project in the field of radio interference reduction. This project, under the joint sponsorship of the Society of Automotive Engineers and the Radio Manufacturers Association, is directed toward the establishment of measuring for the determination of the magnitude of the radiations from automotive equipment and, ultimately, the establishment of the limits of tolerable radiation based, of course, jointly on the needs of the radio services and on the requirements of reliability and economical operation of automotive equipment.

As was reported by Dr. Baker, the work of the joint committee is directed by Mr. P. J. Kent of the Chrysler Corporation in its purely automotive phases while the radio phases of the work are under the direction of Mr. J. T. Filgate of the United American Bosch Corporation. Mr. L. C. E. Horle of New York City has been retained by the Radio Manufacturers Association for the detailed work in the development of the measuring equipment and its subsequent induction into field service.

Both Mr. Kent and Mr. Horle were present at the A.S.A. Committee meeting and were invited to report on the progress made in this joint automotive-radio work. Mr. Kent pointed out at some length the extensive investigations that have been undertaken by the automotive manufacturers in the determination of the influence on motor performance of the various methods known to be effective for the reduction of radio interference. It was specially pointed out that as a primary step in the provision of radio interference elimination means it is essential that the quantitative influence of suppressors and other interference suppression means on motor economy, life, spark plug characteristics, cold starting, low and high-speed operation, etc., be determined. Already much work has been done in a number of automotive research laboratories along these lines and, as Mr. Kent pointed out, with its completion there will be available precisely quantitative data on these influences all of which will be found important in the establishment of the most generally satisfactory means for the suppression of radiation from automotive equipment.

It was reported that, in general, the commonly used methods of measurement of field strength fail in this field because of the unusual wave form of the disturbing radiation. While as yet no precise data on this point is available, it has been found that all types of "click" interference with radio reception have surprisingly great peak values along with durations that are surprisingly short. Thus some sorts of "click" interference, usually not of automotive origin, are found to be of the order of hundreds of millivolts per meter in peak intensity although of durations of only a few microseconds and hence of relatively insignificant power thus making ineffective the usual means of field strength measurement involving the measurement of the mean or R.M.S. value of the interference and, on the other hand, indicating that the measurement of the peak value of the interference is probably the most representative single measurement that can be made to evaluate the influence of this type of radiation.

The influence of such forms of radio receiving equipment is, of course, quite different than is that of the usual sustained or modulated continuous wave forms and thus requires special treatment not only in apparatus employed for picking up the radiation and for amplifying it but in the ultimate measuring device itself.

The problem is further complicated by the fact that in the case of automotive radiation the unusually "steep" wave form of the power source shocks adjacent conducting structures into natural although relatively highly damped oscillation, the radiation from which may be of the same order as that from the source of the power itself.

In general, the attack on the problem must, therefore, be made by the investigation of radiation throughout the entire useful radio spectrum and with such special apparatus as will allow the differentiation between these impulse types of radiation and other unavoidably present forms of disturbance.

Index to Advertisers

A	
Aalloy Transformer Co., Inc.	760
ABC Radio Laboratories	749
Aene Sound Company	765
Aerovox Corporation	758
Allied Radio Corporation	751
Amperite Corporation	742
Amplifier Co. of America	760
Arrow Sales Corporation	762
Autocrat Radio Company	761
B	
The Brush Development Co.	748
C	
Candlor System Company	756
Capitol Radio Engineering Instit.	745
Central Radio Laboratories	744
Cinacograph Corporation	761
Classified Section	758
Clough-Brenkle Company	759
Columbia Sound Co., Inc.	760
Commercialite Laboratories	764
Commonwealth Products Co.	741
Continental Carbon, Inc.	761
Cornell-Dubilier Corp.	754
Coyne Electrical School	705
D	
Dencose, Inc.	749
Dodge's Institute	764
E	
Electrad, Inc.	762
Electric Institute	750
G	
General Cement Mfg. Company	745
General Electric Company	Back Cover
Gillette Radio Corp.	748
Goldstone Radio Company	756
Grenbank Company	753
H	
Hammarlund Mfg. Company	742
Hayward Radio Service	759
Herald Radio Sales	745
Hudson Steelalloys Co.	758
Hygrade-Sylvania Corp.	747
I	
International Correspondence Schools	767
International Radio Corp.	752
J	
Jobs & Careers	754
L	
The Lifetime Corporation	762
Lincoln Engineering School	760
M	
Metal Cast Products Co.	762
Midwest Radio Corporation	755
Million Radio & Tel. Labs.	763
Modern Radio & Tel. Company	758
N	
National Radio Institute	707
National Union Radio Corp.	752
O	
Oxford-Tartak Radio Co.	744
P	
Pacific Radio Publ. Co.	756
Popular Book Corp.	757
Precision Apparatus Corp.	767
R	
Racon Electric Co., Inc.	754
Radio & Technical Publ. Co.	760
Radio & Television Institute	753
Radio Circular Company	759
Radio City Products Company	757
Radio Constructors Labs.	742, 765
Radio Publications	766
Radio Training Assoc. of America	759
Radolek Company	768
Raytheon Production Corp.	758
RCA Institutes, Inc.	762
RCA Mfg. Company, Inc.	759
Readrite Meter Works	746
Remington Radio & Elec. Corp.	763
Remington Rand, Inc.	754
S	
S.O.S. Corporation	764
Sears, Roebuck & Co.	749
Shallcross Mfg. Company	768
Solar Mfg. Company	760
South Bend Lathe Works	767
Sprague Products Co.	749
Spragberry Academy of Radio	743
Standard Transformer Corp.	745
Supreme Instruments Corp.	Inside Front Cover
T	
Teleplex Company	754
Theor Radio Company	749
The Trailer Plan Shop	761
Triplet Electrical Instrument Co.	759
Tri-State College	763
U	
Uncle Dave's Radio Shack	742
United Transformer Corp.	765
W	
The Ward Products Corp.	742
Wellworth Trading Co.	753, 757
Weston Elec. Instrument Corp.	741
Wholesale Radio Service Co., Inc.	750
Wright-DeCoster, Inc.	767
Z	
Zephyr Radio Company	762

(While every precaution is taken to insure accuracy, we cannot guarantee against the possibility of an occasional change or omission in the preparation of this index.)

Please Say That You Saw It in RADIO-CRAFT

Announcing a New Book for Radio Men!

Official Radio Service Handibook
by **J. T. Bernsley**



List Price **\$4.00**

**OVER
1,000
PAGES**

Over 750 Illustrations

6 x 9 inches

Beautiful Leatheroid Cover

**OVER 250 PAGES
OF OPERATING NOTES**

Whether it is a fading job, lack of sensitivity, noise within the receiver, aligning a chassis, poor A.V.C. action or any other trouble that is usually the "bugaboo" of most Service Men, you will find the symptoms and remedy clearly described in **OFFICIAL RADIO SERVICE HANDBOOK**. The exact procedure for repairing, as well as the characteristic trouble in almost all models of manufactured sets, will be found in the section on **OPERATING NOTES** over 250 pages of this data, the most important information to any radio man in the servicing field. The material in this section has been arranged, as well as classified, so there is no difficulty in immediately locating the necessary information.

HERE'S the sensational new book on radio servicing that contains *everything* Service Men must know. The book, **OFFICIAL RADIO SERVICE HANDBOOK**, is edited by J. T. Bernsley, foremost radio service authority. This 1936 service guide is the *only book of its kind*—its editorial material is so well prepared that the technical information can be understood by even beginners in radio servicing. Every page contains new material, new illustrations—no reprinted literature or rehashed articles.

Over a thousand actively engaged Service Men have helped prepare the service data found in the **OFFICIAL RADIO SERVICE HANDBOOK**. Their contributions, in the form of service notes, short cuts, and trade secrets make this book the outstanding volume on radio servicing ever to be published.

The **OFFICIAL RADIO SERVICE HANDBOOK** covers thoroughly over 500 radio topics. It tells you how to analyze the latest commercial receiver circuits; how to really make money servicing midget sets; and, how aligning supers can be made easy. It stresses the many uses of different types of test equipment; it gives you short cuts in trouble-shooting and repairing; and, contains over 250 pages of operating notes on 1,000 manufactured receivers. So up-to-date is the **OFFICIAL RADIO SERVICE HANDBOOK** that it explains thoroughly what to do when a receiver with the "Magic Eye" goes "cockeyed."

Service Men, previously advised about this great book on servicing, have already ordered their copy. Order your copy **NOW** if you have not already done so.

SENSATIONAL PRIZE CONTEST!

\$1,800 Worth of Prizes to Be Awarded to Service Men

You should be interested in entering one of the greatest radio contests of all times. There are 147 prizes in valuable servicing equipment and radio accessories, totaling over \$1,800, to be distributed. All the details about entering this contest, including a complete list of the 147 prizes, will be sent upon request—simply mail the coupon below.

Partial Contents of this Great Book

PART 1—CIRCUIT THEORY AND ANALYSIS

R.F. Fundamentals; Superheterodyne Receiver Theory; A.V.C. and Tuning Indicator Circuits; A.F. Fundamentals; Power Supply Theory and Circuits; Speakers, Reproducers and Pick-Ups; Commercial Receiver Circuits of All Types, How to Analyze.

PART 2—MODERN SERVICING AND TEST EQUIPMENT

Fundamentals of Metering and Test Equipment; Standard Servicing Instruments; The Cathode Ray Oscillograph and Associate Instruments; How to Build Essential Servicing Test Instruments.

PART 3—PRACTICAL SHORT-CUTS IN TROUBLE SHOOTING AND REPAIRING

Localizing Trouble by Inspection Methods; Short-Cuts with Test Instruments; How to Quickly and Properly Perform All Types of Repairs; Unusual Servicing Experiences; Tube Troubles and Characteristics.

PART 4—SPECIALIZED RECEIVER AND INSTALLATION DATA

All-Wave and High Fidelity Receiver Servicing and Installation Data; Auto Radio Receiver and Installation; Specialized Servicing and Installation (Remote Tuning Controls, Home Recording, Automatic Record Changers, Apartment House Antennas, etc., etc.); Eliminating Noise Interference.

PART 5—MODERNIZATION AND CONVERSION DATA

Modernizing and Improving Methods for All Types of Receivers; Converting A.C. Receivers for D.C. Operation and Vice Versa.

PART 6—SOCIAL AND ECONOMIC PROBLEMS OF THE SERVICE MAN

Improving Knowledge and Technique; Social Problems—How to Organize, Listing of Servicemen's Organizations; The Future of the Servicing Profession.

PART 7—OPERATING NOTES AND PRACTICAL DATA LISTINGS

Operating Notes on Over 1,000 Receivers; I.F. Peaks of Approximately 3,000 Receivers; Voltage Dividers for 300 Receivers; Speaker Field Listing; Radio Mathematics and Measurements.

**CLIP
COUPON
MAIL
TODAY!**

GERNSBACK PUBLICATIONS, Inc.
99 Hudson St., New York, N. Y.

RC-636

Gentlemen: Enclosed you will find my remittance of \$1.00 for one copy of the **OFFICIAL RADIO SERVICE HANDBOOK**. YOU ARE TO SEND THIS BOOK TO ME POSTAGE PREPAID.

SEND ME IMMEDIATELY THE CONTEST BLANK FOR ENTRY IN THE \$1,800 PRIZE CONTEST.

Name

Address

City State

(We accept cash, stamps, money orders or U.S. checks in connection with this offer. If you send cash, be sure to register your letter.)

GERNSBACK PUBLICATIONS, INC.
99 Hudson Street New York, N. Y.

**RADIO SERVICE MEN
GET FREE COPY**

GENERAL  ELECTRIC

SERVICE NOTES

1930 - 1935

HOW TO GET THIS BOOK

FREE

THIS OFFER EXPIRES MAY 30, 1936

Simply return **CARTON LABELS FROM 10 G-E "V-DOUBLET" ANTENNA KITS**, to your G-E Radio Distributor and this new book of practical information will be yours. Better act **NOW!** Every radio service man can use a copy of General Electric Radio Service Notes for 1930 to 1935.



THE GENERAL ELECTRIC "V-DOUBLET" ALL-WAVE ANTENNA OFFERS REAL OPPORTUNITIES FOR ALERT SERVICE MEN

If you make a survey of your neighborhood, you'll find hundreds of radio owners who need a G-E "V-doublet" All-wave Antenna. Service men can make good profits selling and installing this noise-reducing antenna system. The "V-doublet" gives excellent sensitivity on all short-wave frequencies . . . takes full advantage of the directional effects . . . reduces "man-made" static . . . equally effective for standard broadcasts . . . and is easy to install.

Your nearest G-E Radio Distributor will gladly give you complete information.

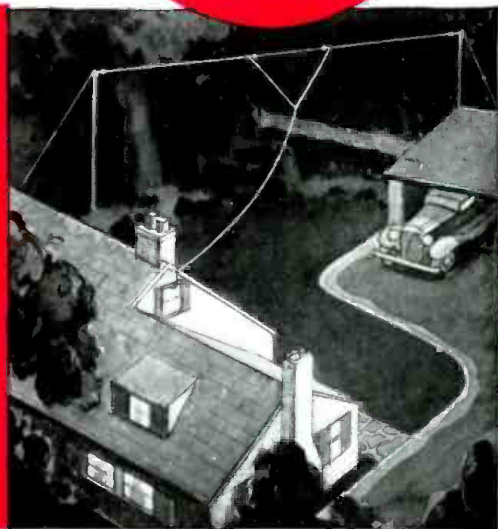

GENERAL ELECTRIC

The Original Metal-tube Radio

APPLIANCE AND MERCHANDISE DEPARTMENT, GENERAL ELECTRIC COMPANY, BRIDGEPORT, CONN.